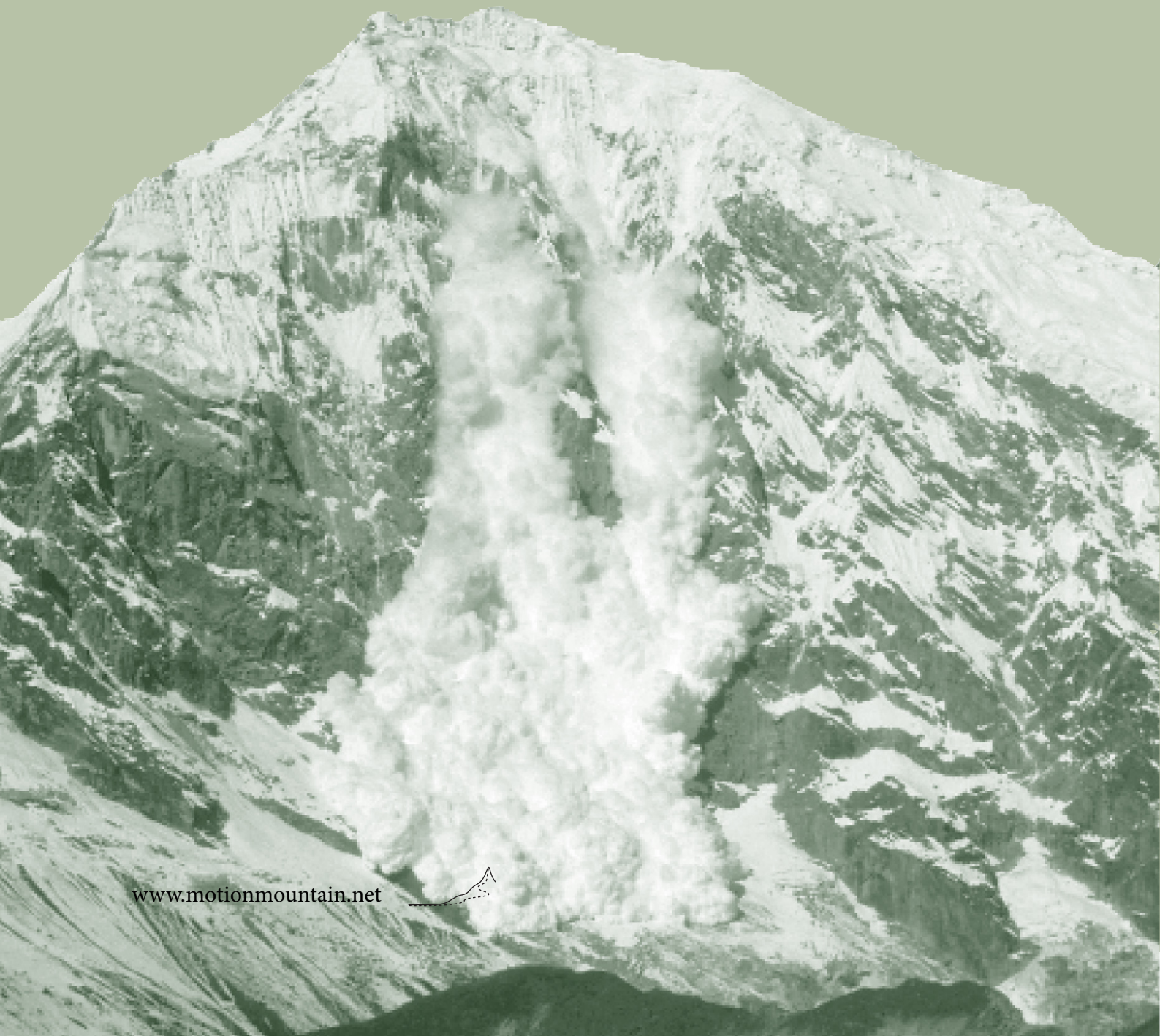


Christoph Schiller

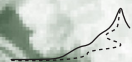
# MOTION MOUNTAIN

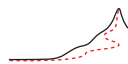
THE ADVENTURE OF PHYSICS – VOL. I

FALL, FLOW AND HEAT



[www.motionmountain.net](http://www.motionmountain.net)

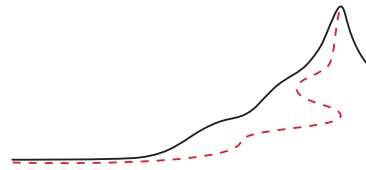






Christoph Schiller

MOTION MOUNTAIN



The Adventure of Physics  
Volume I

Fall, Flow and Heat

Edition 24.24, available as free pdf at  
[www.motionmountain.net](http://www.motionmountain.net)

Editio vicesima quarta.

Proprietas scriptoris © Chrestophori Schiller  
quarto anno Olympiadis vicesimae nonae.

Omnia proprietatis iura reservantur et vindicantur.  
Imitatio prohibita sine auctoris permissione.  
Non licet pecuniam expetere pro aliquo, quod  
partem horum verborum continet; liber  
pro omnibus semper gratuitus erat et manet.

Twenty-fourth edition.

Copyright © 2011 by Christoph Schiller,  
the fourth year of the 29<sup>th</sup> Olympiad.



This pdf file is licensed under the Creative Commons Attribution-Noncommercial-No Derivative Works 3.0 Germany Licence, whose full text can be found on the website [creativecommons.org/licenses/by-nc-nd/3.0/de](https://creativecommons.org/licenses/by-nc-nd/3.0/de), with the additional restriction that reproduction, distribution and use, in whole or in part, in *any* product or service, be it commercial or not, is not allowed without the written consent of the copyright owner. The pdf file was and remains free for everybody to read, store and print for personal use, and to distribute electronically, but only in unmodified form and at no charge.

To Britta, Esther and Justus Aaron

τῷ ἐμοὶ δαίμονι



Die Menschen stärken, die Sachen klären.



# PREFACE

“Primum movere, deinde docere.\*”

Antiquity”

This book is written for anybody who is curious about nature and motion. Curiosity about how people, animals, things, images and space move leads to many adventures. This volume presents the best of them in the domain of everyday life.

Carefully observing everyday motion allows us to deduce six essential statements: everyday motion is continuous, conserved, relative, reversible, mirror-invariant – and lazy. Yes, nature is indeed lazy: in every motion, it minimizes change. This text explores how these six results are deduced and how they fit with all those observations that seem to contradict them.

In the structure of modern physics, shown in [Figure 1](#), the results on everyday motion form the major part of the starting point at the bottom. The present volume is the first of a six-volume overview of physics. It resulted from a threefold aim I have pursued since 1990: to present motion in a way that is simple, up to date and captivating.

In order to be *simple*, the text focuses on concepts, while keeping mathematics to the necessary minimum. Understanding the concepts of physics is given precedence over using formulae in calculations. The whole text is within the reach of an undergraduate.

In order to be *up to date*, the text is enriched by the many gems – both theoretical and empirical – that are scattered throughout the scientific literature.

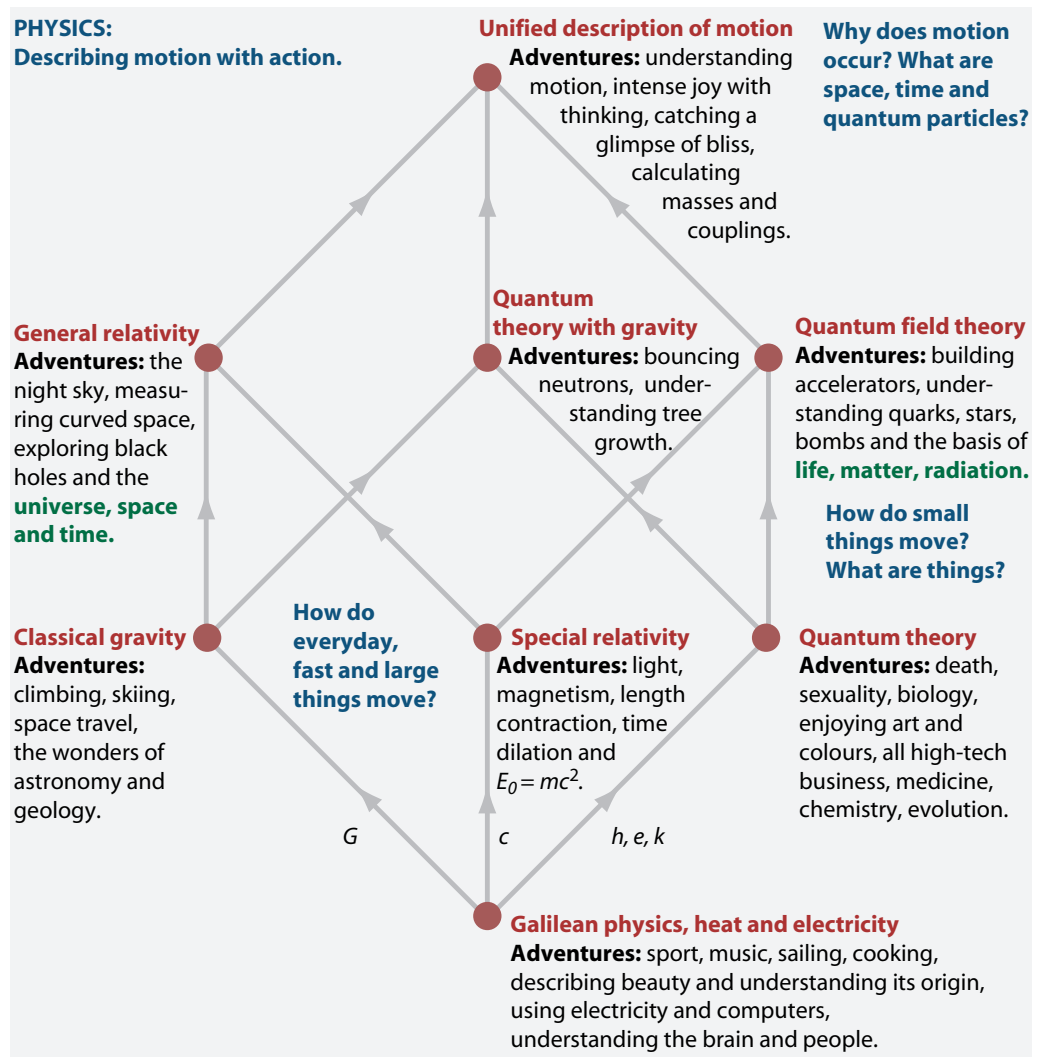
In order to be *captivating*, the text tries to startle the reader as much as possible. Reading a book on general physics should be like going to a magic show. We watch, we are astonished, we do not believe our eyes, we think, and finally we understand the trick. When we look at nature, we often have the same experience. Indeed, every page presents at least one surprise or provocation for the reader to think about. Numerous interesting challenges are proposed.

The motto of the text, *die Menschen stärken, die Sachen klären*, a famous statement by Hartmut von Hentig on pedagogy, translates as: ‘To fortify people, to clarify things.’ Clarifying things requires courage, as changing habits of thought produces fear, often hidden by anger. But by overcoming our fears we grow in strength. And we experience intense and beautiful emotions. All great adventures in life allow this, and exploring motion is one of them. Enjoy it.

Munich, 24 June 2011.

---

\* ‘First move, then teach.’ In modern languages, the mentioned type of *moving* (the heart) is called *motivating*; both terms go back to the same Latin root.



**FIGURE 1** A complete map of physics: the connections are defined by the speed of light  $c$ , the gravitational constant  $G$ , the Planck constant  $h$ , the Boltzmann constant  $k$  and the elementary charge  $e$ .

### ADVICE FOR LEARNERS

In my experience as a teacher, there was one learning method that never failed to transform unsuccessful pupils into successful ones: if you read a book for study, summarize every section you read, *in your own words, aloud*. If you are unable to do so, read the section again. Repeat this until you can clearly summarize what you read in your own words, aloud. You can do this alone in a room, or with friends, or while walking. If you do this with everything you read, you will reduce your learning and reading time significantly. In addition, you will enjoy learning from good texts much more and hate bad texts much less. Masters of the method can use it even while listening to a lecture, in a low voice, thus avoiding to ever take notes.



## USING THIS BOOK

Text in green, as found in many marginal notes, marks a link that can be clicked in a pdf reader. Such green links are either bibliographic references, footnotes, cross references to other pages, challenge solutions, or pointers to websites.

Solutions and hints for *challenges* are given in the appendix. Challenges are classified as research level (r), difficult (d), standard student level (s) and easy (e). Challenges of type r, d or s for which no solution has yet been included in the book are marked (ny).

## FEEDBACK AND SUPPORT

This text is and will remain free to download from the internet. I would be delighted to receive an email from you at [fb@motionmountain.net](mailto:fb@motionmountain.net), especially on the following issues:

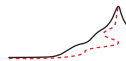
- Challenge 1 s
- What was unclear and should be improved?
  - What story, topic, riddle, picture or movie did you miss?
  - What should be corrected?

In order to simplify annotations, the pdf file allows adding yellow sticker notes in Adobe Reader.

Alternatively, you can provide feedback on [www.motionmountain.net/wiki](http://www.motionmountain.net/wiki). Help on the specific points listed on the [www.motionmountain.net/help.html](http://www.motionmountain.net/help.html) web page would be particularly welcome. All feedback will be used to improve the next edition. On behalf of all readers, thank you in advance for your input. For a particularly useful contribution you will be mentioned – if you want – in the acknowledgements, receive a reward, or both.

Your donation to the charitable, tax-exempt non-profit organisation that produces, translates and publishes this book series is welcome! For details, see the web page [www.motionmountain.net/donation.html](http://www.motionmountain.net/donation.html). If you want, your name will be included in the sponsor list. Thank you in advance for your help, on behalf of all readers across the world.

A paper edition of this book, printed on demand and delivered by mail to any address, can be ordered at [stores.lulu.com/motionmountain](http://stores.lulu.com/motionmountain). But above all, enjoy the reading!



# CONTENTS

- 14 1 WHY SHOULD WE CARE ABOUT MOTION?  
Does motion exist? 15 • How should we talk about motion? 17 • What are the types of motion? 19 • Perception, permanence and change 23 • Does the world need states? 25 • Galilean physics in six interesting statements 27 • Curiosities and fun challenges about motion 28 • Summary on motion 31
- 32 2 FROM MOTION MEASUREMENT TO CONTINUITY  
What is velocity? 33 • What is time? 38 • Clocks 41 • Why do clocks go clockwise? 44 • Does time flow? 45 • What is space? 45 • Are space and time absolute or relative? 48 • Size – why area exists, but volume does not 49 • What is straight? 54 • A hollow Earth? 55 • Curiosities and fun challenges about everyday space and time 56 • Summary about everyday space and time 66
- 68 3 HOW TO DESCRIBE MOTION – KINEMATICS  
Throwing, jumping and shooting 70 • Enjoying vectors 73 • What is rest? What is velocity? 74 • Acceleration 76 • Objects and point particles 78 • Legs and wheels 81 • Curiosities and fun challenges about kinematics 83 • Summary of kinematics 84
- 86 4 FROM OBJECTS AND IMAGES TO CONSERVATION  
Motion and contact 87 • What is mass? 88 • Momentum and mass 90 • Is motion eternal? – Conservation of momentum 95 • More conservation – energy 96 • The cross product, or vector product 99 • Rotation 101 • Rolling wheels 105 • How do we walk? 106 • Curiosities and fun challenges about conservation 107 • Summary on conservation 113
- 114 5 FROM THE ROTATION OF THE EARTH TO THE RELATIVITY OF MOTION  
How does the Earth rotate? 121 • Does the Earth move? 125 • Is velocity absolute? – The theory of everyday relativity 130 • Is rotation relative? 132 • Curiosities and fun challenges about relativity 132 • Legs or wheels? – Again 137 • Summary on Galilean relativity 139
- 141 6 MOTION DUE TO GRAVITATION  
Properties of gravitation 145 • The gravitational potential 148 • The shape of the Earth 150 • Dynamics – how do things move in various dimensions? 152 • Gravitation in the sky 152 • The Moon 155 • Orbits – and conic sections 157 • Tides 160 • Can light fall? 164 • What is mass? – Again 165 • Curiosities and fun challenges about gravitation 166 • Summary on gravitation 181
- 182 7 CLASSICAL MECHANICS AND THE PREDICTABILITY OF MOTION  
Should one use force? Power? 182 • Forces, surfaces and conservation 185 • Friction and motion 185 • Friction, sport, machines and predictability 187 • Complete states – initial conditions 190 • Do surprises exist? Is the future determined? 191 • Free will 193 • Summary on predictability 194 • Global descriptions of motion 194
- 199 8 MEASURING CHANGE WITH ACTION  
The principle of least action 203 • Lagrangians and motion 206 • Why is motion so often bounded? 208 • Curiosities and fun challenges about Lagrangians 211 • Summary on action 214

- 215 9 MOTION AND SYMMETRY  
 Why can we think and talk about the world? 216 • Viewpoints 219 • Symmetries and groups 220 • Representations 221 • Symmetries, motion and Galilean physics 224 • Reproducibility, conservation and Noether's theorem 227 • Curiosities and fun challenges about symmetry 231 • Parity and time invariance 232 • Summary on symmetry 232
- 234 10 SIMPLE MOTIONS OF EXTENDED BODIES – OSCILLATIONS AND WAVES  
 Waves and their motion 237 • Why can we talk to each other? – Huygens' principle 243 • Why is music so beautiful? 244 • Is ultrasound imaging safe for babies? 247 • Signals 248 • Solitary waves and solitons 250 • Curiosities and fun challenges about waves and extended bodies 253 • Summary on waves and oscillations 262
- 263 11 DO EXTENDED BODIES EXIST? – LIMITS OF CONTINUITY  
 Mountains and fractals 263 • Can a chocolate bar last forever? 263 • The case of Galileo Galilei 265 • How high can animals jump? 267 • Felling trees 267 • The sound of silence 269 • Little hard balls 269 • The motion of fluids 273 • Curiosities and fun challenges about fluids 276 • Curiosities and fun challenges about solids 285 • Summary on extension 289 • What can move in nature? – Flows 290
- 292 12 FROM HEAT TO TIME-INVARIANCE  
 Temperature 292 • Thermal energy 294 • Entropy 297 • Flow of entropy 299 • Do isolated systems exist? 300 • Why do balloons take up space? – The end of continuity 301 • Brownian motion 302 • Entropy and particles 304 • The minimum entropy of nature – the quantum of information 306 • Why can't we remember the future? 307 • Is everything made of particles? 308 • Why stones can be neither smooth nor fractal, nor made of little hard balls 309 • Curiosities and fun challenges about heat and reversibility 310 • Summary on heat and time-invariance 317
- 318 13 SELF-ORGANIZATION AND CHAOS – THE SIMPLICITY OF COMPLEXITY  
 Curiosities and fun challenges about self-organization 326 • Summary on self-organization and chaos 330
- 331 14 FROM THE LIMITATIONS OF PHYSICS TO THE LIMITS OF MOTION  
 Research topics in classical dynamics 331 • What is contact? 332 • Precision and accuracy 332 • Can all of nature be described in a book? 333 • Something is wrong about our description of motion 334 • Why is measurement possible? 335 • Is motion unlimited? 335
- 336 A NOTATION AND CONVENTIONS  
 The Latin alphabet 336 • The Greek alphabet 338 • The Hebrew alphabet and other scripts 340 • Numbers and the Indian digits 340 • The symbols used in the text 341 • Calendars 343 • People Names 345 • Abbreviations and eponyms or concepts? 345
- 347 B UNITS, MEASUREMENTS AND CONSTANTS  
 SI units 347 • Curiosities and fun challenges about units 350 • Precision and accuracy of measurements 352 • Limits to precision 353 • Physical constants 354 • Useful numbers 359
- 360 C SOURCES OF INFORMATION ON MOTION
- 365 CHALLENGE HINTS AND SOLUTIONS



404 BIBLIOGRAPHY

433 CREDITS

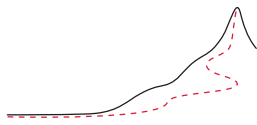
Acknowledgements 433 • Film credits 434 • Image credits 434





## FALL, FLOW AND HEAT

In our quest to learn how things move,  
the experience of hiking and other motion  
leads us to introduce the concepts of  
velocity, time, length, mass and temperature,  
and to use them to *measure change*.  
We discover how to float in free space,  
why we have legs instead of wheels,  
why disorder can never be eliminated,  
and why one of the most difficult open issues  
in science is the flow of water through a tube.



## CHAPTER 1

# WHY SHOULD WE CARE ABOUT MOTION?

“All motion is an illusion.”  
Zeno of Elea\*

**W**HAM! The lightning striking the tree nearby violently disrupts our quiet forest walk and causes our hearts to suddenly beat faster. In the top of the tree we see the fire start and fade again. The gentle wind moving the leaves around us helps to restore the calmness of the place. Nearby, the water in a small river follows its complicated way down the valley, reflecting on its surface the ever-changing shapes of the clouds.

Motion is everywhere: friendly and threatening, terrible and beautiful. It is fundamental to our human existence. We need motion for growing, for learning, for thinking and for enjoying life. We use motion for walking through a forest, for listening to its noises and for talking about all this. Like all animals, we rely on motion to get food and to survive dangers. Like all living beings, we need motion to reproduce, to breathe and to digest. Like all objects, motion keeps us warm.

Motion is the most fundamental observation about nature at large. It turns out that *everything* that happens in the world is some type of motion. There are no exceptions. Motion is such a basic part of our observations that even the origin of the word is lost in the darkness of Indo-European linguistic history. The fascination of motion has always made it a favourite object of curiosity. By the fifth century BCE in ancient Greece, its study had been given a name: *physics*.

Ref. 1

Motion is also important to the human condition. What can we know? Where does the world come from? Who are we? Where do we come from? What will we do? What should we do? What will the future bring? What is death? Where does life lead? All these questions are about motion. The study of motion provides answers that are both deep and surprising.

Ref. 2

Motion is mysterious. Though found everywhere – in the stars, in the tides, in our eyelids – neither the ancient thinkers nor myriads of others in the 25 centuries since then have been able to shed light on the central mystery: *what is motion?* We shall discover that the standard reply, ‘motion is the change of place in time’, is inadequate. Just recently an answer has finally been found. This is the story of the way to find it.

Motion is a part of human experience. If we imagine human experience as an island, then destiny, symbolized by the waves of the sea, carried us to its shore. Near the centre of

---

\* Zeno of Elea (c. 450 BCE), one of the main exponents of the Eleatic school of philosophy.

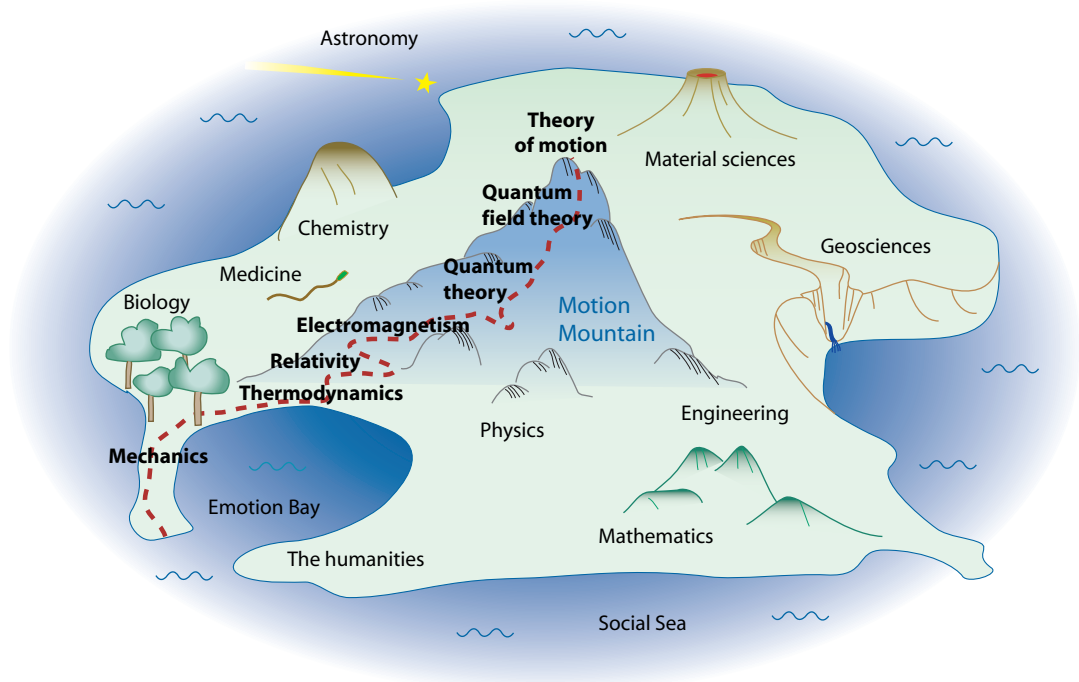


FIGURE 2 Experience Island, with Motion Mountain and the trail to be followed.

the island an especially high mountain stands out. From its top we can see over the whole landscape and get an impression of the relationships between all human experiences, in particular between the various examples of motion. This is a guide to the top of what I have called Motion Mountain (see Figure 2; a less artistic but more exact version is given in Figure 1). The hike is one of the most beautiful adventures of the human mind. The first question to ask is:

### DOES MOTION EXIST?

“Das Rätsel gibt es nicht. Wenn sich eine Frage überhaupt stellen läßt, so kann sie beantwortet werden.\*”

Ludwig Wittgenstein, *Tractatus*, 6.5

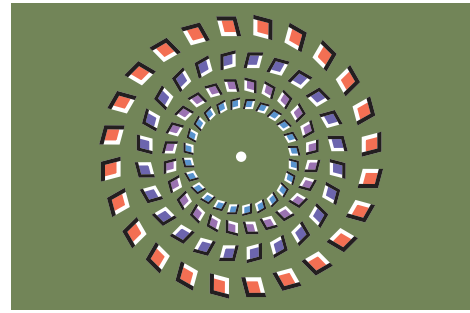
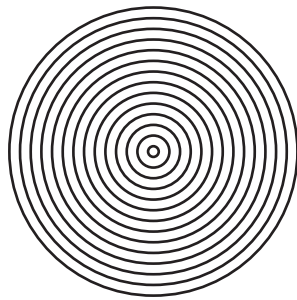
To sharpen the mind for the issue of motion's existence, have a look at Figure 3 or Figure 4 and follow the instructions. In all cases the figures seem to rotate. You can experience similar effects if you walk over cobblestone pavement that is arranged in arched patterns or if you look at the numerous motion illusions that Kitaoka Akiyoshi presents at [www.ritsumei.ac.jp/~akitaoka](http://www.ritsumei.ac.jp/~akitaoka). How can we make sure that real motion is different from these or other similar illusions?

Challenge 2 s

Many scholars simply argued that motion does not exist at all. Their arguments deeply influenced the investigation of motion over many centuries. For example, the Greek

Ref. 5

\* ‘The riddle does not exist. If a question can be put at all, it can also be answered.’



**FIGURE 3** Illusions of motion: look at the figure on the left and slightly move the page, or look at the white dot at the centre of the figure on the right and move your head back and forward.

philosopher Parmenides (born *c.* 515 BCE in Elea, a small town near Naples) argued that since nothing comes from nothing, change cannot exist. He underscored the *permanence* of nature and thus consistently maintained that all change and thus all motion is an illusion.

Ref. 6

Heraclitus (*c.* 540 to *c.* 480 BCE) held the opposite view. He expressed it in his famous statement πάντα ῥεῖ ‘panta rhei’ or ‘everything flows.’\* He saw change as the essence of nature, in contrast to Parmenides. These two equally famous opinions induced many scholars to investigate in more detail whether in nature there are *conserved* quantities or whether *creation* is possible. We will uncover the answer later on; until then, you might ponder which option you prefer.

Challenge 3 s

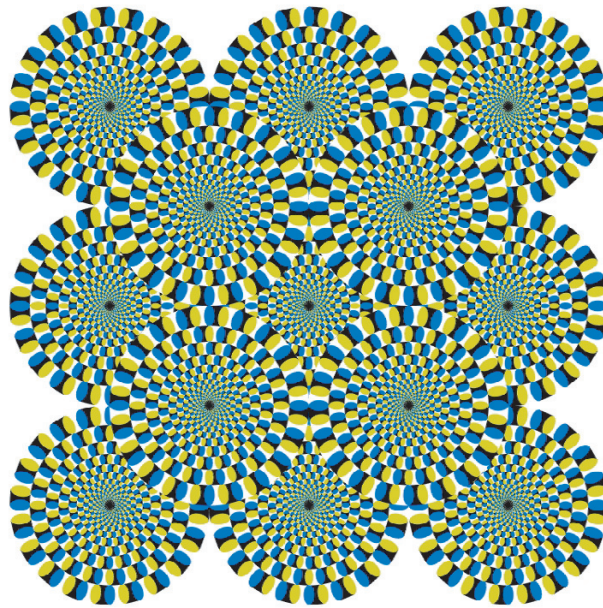
Parmenides’ collaborator Zeno of Elea (born *c.* 500 BCE) argued so intensely against motion that some people still worry about it today. In one of his arguments he claims – in simple language – that it is impossible to slap somebody, since the hand first has to travel halfway to the face, then travel through half the distance that remains, then again so, and so on; the hand therefore should never reach the face. Zeno’s argument focuses on the relation between *infinity* and its opposite, finitude, in the description of motion. In modern quantum theory, a related issue is a subject of research up to this day.

Ref. 7

Zeno also maintained that by looking at a moving object at a *single* instant of time, one cannot maintain that it moves. He argued that at a single instant of time, there is no difference between a moving and a resting body. He then deduced that if there is no difference at a single time, there cannot be a difference for longer times. Zeno therefore questioned whether motion can clearly be distinguished from its opposite, *rest*. Indeed, in the history of physics, thinkers switched back and forward between a positive and a negative answer. It was this very question that led Albert Einstein to the development of general relativity, one of the high points of our journey. In our adventure, we will explore all known differences between motion and rest. Eventually, we will dare to ask whether single instants of time do exist at all. Answering this question is essential for reaching the top of Motion Mountain.

When we explore quantum theory, we will discover that motion is indeed – to a certain extent – an illusion, as Parmenides claimed. More precisely, we will show that motion is observed only due to the limitations of the human condition. We will find that we experience motion only because

\* [Appendix A](#) explains how to read Greek text.



**FIGURE 4** Zoom this image to large size or approach it closely in order to enjoy its apparent motion (© Michael Bach after the discovery of Kitaoka Akiyoshi).

- we have a finite size,
  - we are made of a large but finite number of atoms,
  - we have a finite but moderate temperature,
  - we are electrically neutral,
  - we are large compared with a black hole of our same mass,
  - we are large compared with our quantum mechanical wavelength,
  - we are small compared with the universe,
  - we have a limited memory,
  - we are forced by our brain to approximate space and time as continuous entities, and
  - we are forced by our brain to approximate nature as made of different parts.
- If any one of these conditions were not fulfilled, we would not observe motion; motion, then, would not exist! If that were not enough, note that none of the conditions requires human beings; they are equally valid for many animals and machines. Each of these conditions can be uncovered most efficiently if we start with the following question:

#### HOW SHOULD WE TALK ABOUT MOTION?

“ Je hais le mouvement, qui déplace les lignes,  
Et jamais je ne pleure et jamais je ne ris.  
Charles Baudelaire, *La Beauté*.<sup>\*</sup> ”

Like any science, the approach of physics is twofold: we advance with *precision* and with *curiosity*. Precision makes meaningful communication possible, and curiosity makes it

<sup>\*</sup> Charles Baudelaire (b. 1821 Paris, d. 1867 Paris) *Beauty*: ‘I hate movement, which changes shapes, and never do I weep and never do I laugh.’

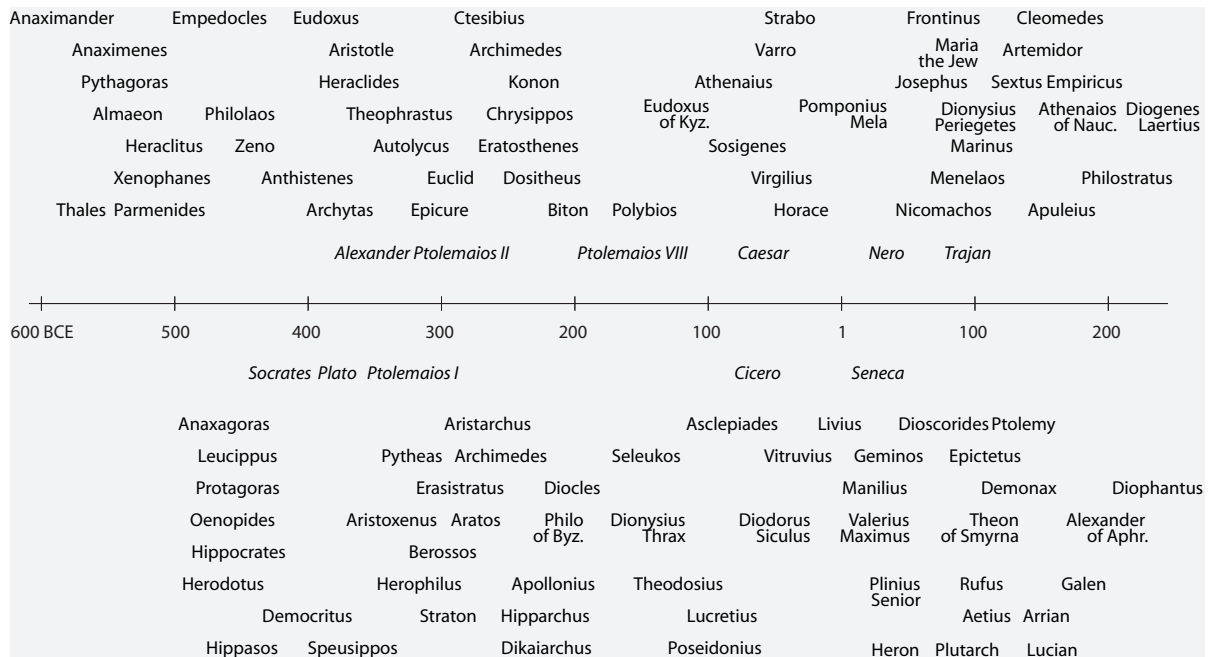


FIGURE 5 A time line of scientific and *political* personalities in antiquity (the last letter of the name is aligned with the year of death).



FIGURE 6 An example of how precision of observation can lead to the discovery of new effects: the deformation of a tennis ball during the c. 6 ms of a fast bounce (© International Tennis Federation).

worthwhile. Be it an eclipse, a beautiful piece of music, or a feat at the Olympic games: the world is full of fascinating examples of motion.\*

If you ever find yourself talking about motion, whether to understand it more precisely or more deeply, you are taking steps up Motion Mountain. The examples of Figure 7 make the point. When you fill a bucket with a small amount of water, it does not hang vertically. (Why?) If you continue adding water, it starts to hang vertically at a certain moment. How much water is necessary? When you pull a thread from a reel in the way shown, the reel will move either forwards or backwards, depending on the angle at which you pull. What is the limiting angle between the two possibilities?

High precision means going into fine details, and being attuned to details actually *increases* the pleasure of the adventure.\*\* The higher we get on Motion Mountain, the further we can see and the more our curiosity is rewarded. The views offered are breathtaking, especially from the very top. The path we will follow – one of the many possible

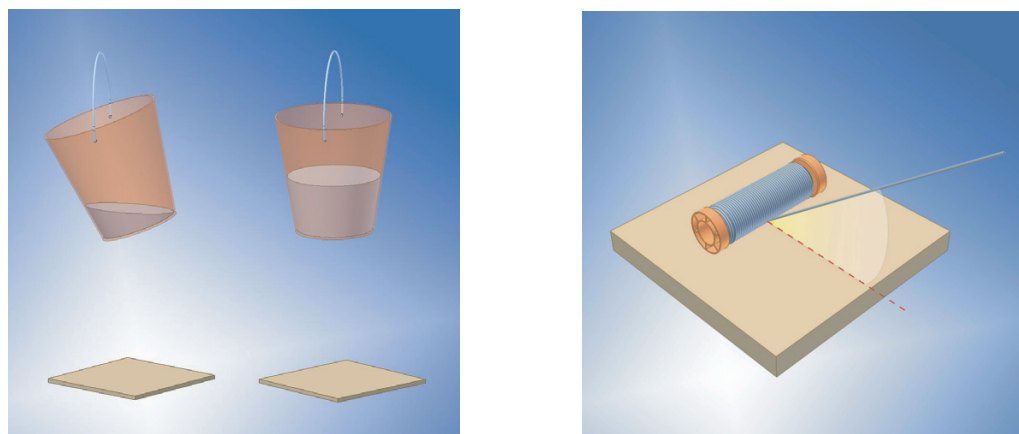
Challenge 4 s

Ref. 9 \* For a collection of interesting examples of motion in everyday life, see the excellent book by Walker.

Challenge 5 s

\*\* Distrust anybody who wants to talk you *out* of investigating details. He is trying to deceive you. Details are important. Be vigilant also during *this* walk.





**FIGURE 7** How much water is required to make a bucket hang vertically? At what angle does the pulled reel change direction of motion? (© Luca Gastaldi).

Ref. 10

routes – starts from the side of biology and directly enters the forest that lies at the foot of the mountain.

Intense curiosity drives us to go straight to the limits: understanding motion requires exploration of the largest distances, the highest velocities, the smallest particles, the strongest forces and the strangest concepts. Let us begin.

#### WHAT ARE THE TYPES OF MOTION?

“Every movement is born of a desire for change.”  
Antiquity

A good place to obtain a general overview on the types of motion is a large library (see [Table 1](#)). The domains in which motion, movements and moves play a role are indeed varied. Already in ancient Greece people had the suspicion that all types of motion, as well as many other types of change, are related. Three categories of change are commonly recognized:

1. *Transport*. The only type of change we call motion in everyday life is material transport, such as a person walking, a leaf falling from a tree, or a musical instrument playing. Transport is the change of position or orientation of objects, fluids included. To a large extent, the behaviour of people also falls into this category.
2. *Transformation*. Another category of change groups observations such as the dissolution of salt in water, the formation of ice by freezing, the rotting of wood, the cooking of food, the coagulation of blood, and the melting and alloying of metals. These changes of colour, brightness, hardness, temperature and other material properties are all transformations. Transformations are changes not visibly connected with transport. To this category, a few ancient thinkers added the emission and absorption of light. In the twentieth century, these two effects were proven to be special cases of transformations, as were the newly discovered appearance and disappearance of matter, as observed in the Sun and in radioactivity. *Mind change*, such as change of mood,

TABLE 1 Content of books about motion found in a public library.

MOTION TOPICS	MOTION TOPICS
motion pictures and digital effects	motion as therapy for cancer, diabetes, acne and depression
motion perception <a href="#">Ref. 11</a>	motion sickness
motion for fitness and wellness	motion for meditation
motion control and training in sport and singing	motion ability as health check
perpetual motion	motion in dance, music and other performing arts
motion as proof of various gods <a href="#">Ref. 12</a>	motion of planets, stars and angels <a href="#">Ref. 13</a>
economic efficiency of motion	the connection between motional and emotional habits
motion as help to overcome trauma	motion in psychotherapy <a href="#">Ref. 14</a>
locomotion of insects, horses, animals and robots	motion of cells and plants
collisions of atoms, cars, stars and galaxies	growth of multicellular beings, mountains, sunspots and galaxies
motion of springs, joints, mechanisms, liquids and gases	motion of continents, bird flocks, shadows and empty space
commotion and violence	motion in martial arts
motions in parliament	movements in art, sciences and politics
movements in watches	movements in the stock market
movement teaching and learning	movement development in children <a href="#">Ref. 15</a>
musical movements	troop movements <a href="#">Ref. 16</a>
religious movements	bowel movements
moves in chess	cheating moves in casinos <a href="#">Ref. 17</a>
connection between gross national product and citizen mobility	

[Ref. 18](#) of health, of education and of character, is also (mostly) a type of transformation.

[Ref. 19](#) 3. *Growth*. This last and especially important category of change, is observed for animals, plants, bacteria, crystals, mountains, planets, stars and even galaxies. In the nineteenth century, changes in the population of systems, *biological evolution*, and in the twentieth century, changes in the size of the universe, *cosmic evolution*, were added to this category. Traditionally, these phenomena were studied by separate sciences. Independently they all arrived at the conclusion that growth is a combination of transport and transformation. The difference is one of complexity and of time scale.

[Page 15](#) At the beginnings of modern science during the Renaissance, only the study of transport was seen as the topic of physics. Motion was equated to transport. The other two domains were neglected by physicists. Despite this restriction, the field of enquiry remains large, covering a large part of Experience Island. Early scholars differentiated types of transport by their origin. Movements such as those of the legs when walking were classified as *volitional*, because they are controlled by one's will, whereas movements of external



**FIGURE 8** An example of transport, at Mount Etna (© Marco Fulle).

objects, such as the fall of a snowflake, which cannot be influenced by will-power, were classified as *passive*. The complete distinction between passive and volitional motion is made by children by the age of six, and this marks a central step in the development of every human towards a precise description of the environment.\* From this distinction stems the historical but now outdated definition of physics as the science of the motion of non-living things.

The advent of machines forced scholars to rethink the distinction between volitional and passive motion. Like living beings, machines are self-moving and thus mimic volitional motion. However, careful observation shows that every part in a machine is moved by another, so their motion is in fact passive. Are living beings also machines? Are human actions examples of passive motion as well? The accumulation of observations in the last 100 years made it clear that volitional movement\*\* indeed has the same physical properties as passive motion in non-living systems. (Of course, from the emotional viewpoint, the differences are important; for example, *grace* can only be ascribed to volitional movements.) A distinction between the two types of motion is thus unnecessary. But since passive and volitional motion have the same properties, through the study of motion of non-living objects we can learn something about the human condition. This is most evident when touching the topics of determinism, causality, probability, infinity, time and love, to name but a few of the themes we will encounter during our adventure.

Ref. 20

\* Failure to pass this stage completely can result in a person having various strange beliefs, such as believing in the ability to influence roulette balls, as found in compulsive players, or in the ability to move other bodies by thought, as found in numerous otherwise healthy-looking people. An entertaining and informative account of all the deception and self-deception involved in creating and maintaining these beliefs is given by JAMES RANDI, *The Faith Healers*, Prometheus Books, 1989. A professional magician, he presents many similar topics in several of his other books. See also his [www.randi.org](http://www.randi.org) website for more details.

\*\* The word 'movement' is rather modern; it was imported into English from the old French and became popular only at the end of the eighteenth century. It is never used by Shakespeare.



**FIGURE 9** Transport, growth and transformation (© Philip Plisson).



**FIGURE 10** One of the most difficult volitional movements known, performed by Alexander Tsukanov, the first man able to do this: jumping from one ultimate wheel to another (© Moscow State Circus).

In the nineteenth and twentieth centuries other classically held beliefs about motion fell by the wayside. Extensive observations showed that all transformations and all growth phenomena, including behaviour change and evolution, are also examples of transport. In other words, over 2 000 years of studies have shown that the ancient classification of observations was useless: all change is transport.

In the middle of the twentieth century the study of motion culminated in the experimental confirmation of an even more specific idea, previously articulated in ancient Greece: *every type of change is due to the motion of particles*. It takes time and work to reach this conclusion, which appears only when one relentlessly pursues higher and higher precision in the description of nature. The first five parts of this adventure retrace the path to this result. (Do you agree with it?)

Challenge 6 s

The last decade of the twentieth century again completely changed the description of motion: the particle idea turns out to be wrong. This new result, reached through a combination of careful observation and deduction, will be explored in the last part of our adventure. But we still have some way to go before we reach that part, just below the summit of our journey.

At present, at the beginning of our walk, we simply note that history has shown that classifying the various types of motion is not productive. Only by trying to achieve maximum precision can we hope to arrive at the fundamental properties of motion. Precision, not classification, is the path to follow. As Ernest Rutherford said: 'All science is either physics or stamp collecting.'

Ref. 21 To achieve precision in our description of motion, we need to select specific examples of motion and study them fully in detail. It is intuitively obvious that the most precise description is achievable for the *simplest* possible examples. In everyday life, this is the case for the motion of any non-living, solid and rigid body in our environment, such as a stone thrown through the air. Indeed, like all humans, we learned to throw objects long before we learned to walk. Throwing is one of the first physical experiments we performed by ourselves.\* During our early childhood, by throwing stones, toys and other objects until our parents feared for every piece of the household, we explored the perception and the properties of motion. We do the same here.

“Die Welt ist unabhängig von meinem Willen.\*\*”  
Ludwig Wittgenstein, *Tractatus*, 6.373

## PERCEPTION, PERMANENCE AND CHANGE

“Only wimps study only the general case; real scientists pursue examples.”  
Beresford Parlett

Human beings enjoy perceiving. Perception starts before birth, and we continue enjoying it for as long as we can. That is why television, even when devoid of content, is so successful. During our walk through the forest at the foot of Motion Mountain we cannot avoid perceiving. Perception is first of all the ability to *distinguish*. We use the basic mental act of distinguishing in almost every instant of life; for example, during childhood we first learned to distinguish familiar from unfamiliar observations. This is possible in combination with another basic ability, namely the capacity to *memorize* experiences. Memory gives us the ability to experience, to talk and thus to explore nature. Perceiving, classifying and memorizing together form *learning*. Without any one of these three abilities, we could not study motion.

Children rapidly learn to distinguish *permanence* from *variability*. They learn to *recognize* human faces, even though a face never looks exactly the same each time it is seen. From recognition of faces, children extend recognition to all other observations. Recognition works pretty well in everyday life; it is nice to recognize friends, even at night, and

\* The importance of throwing is also seen from the terms derived from it: in Latin, words like *subject* or 'thrown below', *object* or 'thrown in front', and *interjection* or 'thrown in between'; in Greek, it led to terms like *symbol* or 'thrown together', *problem* or 'thrown forward', *emblem* or 'thrown into', and – last but not least – *devil* or 'thrown through'.

\*\* 'The world is independent of my will.'



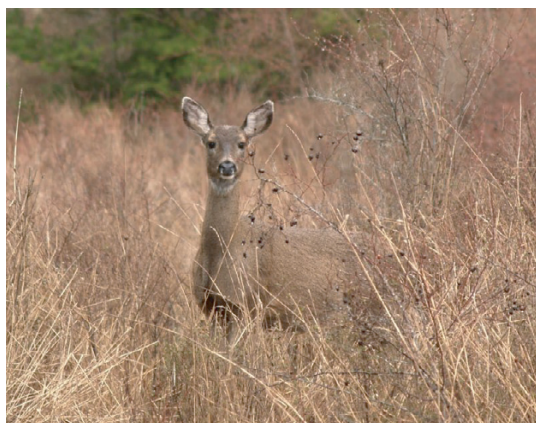


FIGURE 11 How do we distinguish a deer from its environment? (© Tony Rodgers).

even after many beers (not a challenge). The act of recognition thus always uses a form of *generalization*. When we observe, we always have some general idea in our mind. Let us specify the main ones.

Ref. 22 Sitting on the grass in a clearing of the forest at the foot of Motion Mountain, surrounded by the trees and the silence typical of such places, a feeling of calmness and tranquillity envelops us. We are thinking about the essence of perception. Suddenly, something moves in the bushes; immediately our eyes turn and our attention focuses. The nerve cells that detect motion are part of the most ancient part of our brain, shared with birds and reptiles: the brain stem. Then the cortex, or modern brain, takes over to analyse the type of motion and to identify its origin. Watching the motion across our field of vision, we observe two invariant entities: the fixed landscape and the moving animal. After we recognize the animal as a deer, we relax again.

Ref. 23 How did we distinguish between landscape and deer? Perception involves several processes in the eye and in the brain. An essential part for these processes is motion, as is best deduced from the flip film shown in the lower left corners of these pages. Each image shows only a rectangle filled with a mathematically random pattern. But when the pages are scanned in rapid succession, you discern a shape – a square – moving against a fixed background. At any given instant, the square cannot be distinguished from the background; there is no visible object at any given instant of time. Nevertheless it is easy to perceive its motion.\* Perception experiments such as this one have been performed in many variations. For example, it was found that detecting a moving square against a random background is nothing special to humans; flies have the same ability, as do, in fact, all animals that have eyes.

The flip film in the lower left corner, like many similar experiments, illustrates two central attributes of motion. First, motion is perceived only if an *object* can be distinguished from a *background* or *environment*. Many motion illusions focus on this point.\*\* Second,

Ref. 11 \* The human eye is rather good at detecting motion. For example, the eye can detect motion of a point of light even if the change of angle is smaller than that which can be distinguished in a fixed image. Details of this and similar topics for the other senses are the domain of perception research.

\*\* The topic of motion perception is full of interesting aspects. An excellent introduction is chapter 6 of the beautiful text by DONALD D. HOFFMAN, *Visual Intelligence – How We Create What We See*, W.W. Norton



motion is required to *define* both the object and the environment, and to distinguish them from each other. In fact, the concept of space is – among others – an abstraction of the idea of background. The background is extended; the moving entity is localized. Does this seem boring? It is not; just wait a second.

We call the set of localized aspects that remain invariant or permanent during motion, such as size, shape, colour etc., taken together, a (physical) *object* or a (physical) *body*. We will tighten the definition shortly, since otherwise images would be objects as well. In other words, right from the start we experience motion as a *relative* process; it is perceived in relation and in opposition to the environment. The concept of an object is therefore also a relative concept. But the basic conceptual distinction between localized, isolable objects and the extended environment is not trivial or unimportant. First, it has the appearance of a circular definition. (Do you agree?) This issue will keep us busy later on. Second, we are so used to our ability of isolating local systems from the environment that we take it for granted. However, as we will see in the last part of our walk, this distinction turns out to be logically and experimentally impossible!\* Our walk will lead us to discover the reason for this impossibility and its important consequences. Finally, apart from moving entities and the permanent background, we need a third concept, as shown in Table 2.

Challenge 7 s

Page 334

Vol. VI, page 77

Ref. 24

“Wisdom is one thing: to understand the thought which steers all things through all things.”  
Heraclitus of Ephesus

#### DOES THE WORLD NEED STATES?

“Das Feste, das Bestehende und der Gegenstand sind Eins. Der Gegenstand ist das Feste, Bestehende; die Konfiguration ist das Wechselnde, Unbeständige.\*\*”  
Ludwig Wittgenstein, *Tractatus*, 2.027 – 2.0271

What distinguishes the various patterns in the lower left corners of this text? In everyday life we would say: the *situation* or *configuration* of the involved entities. The situation somehow describes all those aspects that can differ from case to case. It is customary to call the list of all *variable* aspects of a set of objects their (*physical*) *state of motion*, or simply their *state*.

The situations in the lower left corners differ first of all in *time*. Time is what makes opposites possible: a child is in a house and the same child is outside the house. Time describes and resolves this type of contradiction. But the state not only distinguishes situations in time: the state contains *all* those aspects of a system (i.e., of a group of objects) that set it apart from all *similar* systems. Two objects can have the same mass, shape, colour, composition and be indistinguishable in all other intrinsic properties; but at least

& Co., 1998. His collection of basic motion illusions can be experienced and explored on the associated [www.cogsci.uci.edu/~ddhoff](http://www.cogsci.uci.edu/~ddhoff) website.

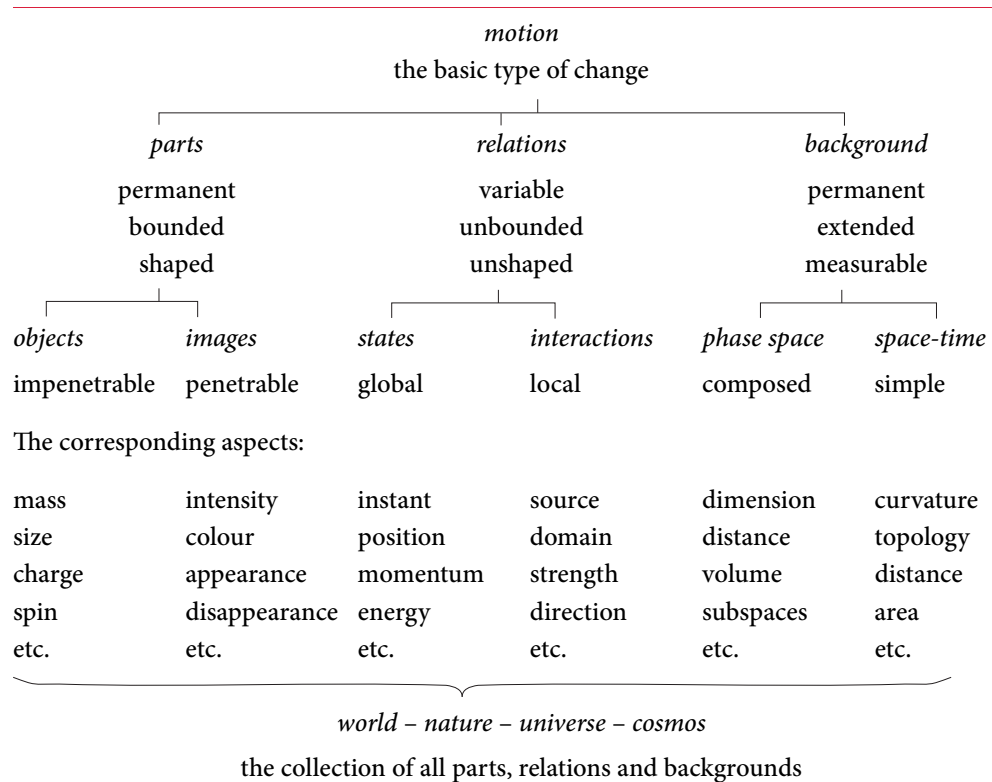
\* Contrary to what is often read in popular literature, the distinction *is* possible in quantum theory. It becomes impossible only when quantum theory is unified with general relativity.

\*\* ‘The fixed, the existent and the object are one. The object is the fixed, the existent; the configuration is the changing, the variable.’





TABLE 2 Family tree of the basic physical concepts.



they will differ in their position, or their velocity, or their orientation. The state pinpoints the *individuality* of a physical system,\* and allows us to distinguish it from exact copies of itself. Therefore, the state also describes the relation of an object or a system with respect to its environment. Or in short: *the state describes all aspects of a system that depend on the observer*. These properties are not boring – just ponder this: does the universe have a state?

## Challenge 9 s

Describing nature as a collection of permanent entities and changing states is the starting point of the study of motion. The observation of motion requires the distinction of permanent, intrinsic properties – describing the objects that move – and changing states – describing the way the objects move. Without this distinction, there is no motion.

The various aspects of objects and of their states are called *observables*. All these rough, preliminary definitions will be refined step by step in the following. Using the terms just introduced, we can say that *motion is the change of state of objects*.\*\*

\* A *physical system* is a localized entity of investigation. In the classification of Table 2, the term ‘physical system’ is (almost) the same as ‘object’ or ‘physical body’. Images are usually not counted as physical systems (though radiation is one). Are holes physical systems?

## Challenge 8 s

\*\* The exact separation between those aspects belonging to the object and those belonging to the state depends on the precision of observation. For example, the length of a piece of wood is not permanent; wood shrinks and bends with time, due to processes at the molecular level. To be precise, the length of a piece of wood is not an aspect of the object, but an aspect of its state. Precise observations thus *shift* the



States are required for the description of motion. In order to proceed and to achieve a *complete* description of motion, we thus need a complete description of objects and a complete description of their possible states. The first approach, called Galilean physics, consists in specifying our *everyday* environment as precisely as possible.

### GALILEAN PHYSICS IN SIX INTERESTING STATEMENTS

The study of everyday motion, Galilean physics, is already worthwhile in itself: we will uncover many results that are in contrast with our usual experience. For example, if we recall our own past, we all have experienced how important, delightful or unwelcome *surprises* can be. Nevertheless, the study of everyday motion shows that there are *no* surprises in nature. Motion, and thus the world, is *predictable* or *deterministic*.

The main surprise is thus that there are no surprises in nature. In fact, we will uncover six aspects of the predictability of everyday motion:

1. We know that eyes, cameras and measurement apparatus have a finite resolution. All have a smallest distance they can observe. We know that clocks have a smallest time they can measure. Nevertheless, in everyday life all movements, their states, as well as space and time, are *continuous*.
2. We all observe that people, music and many other things in motion stop moving after a while. The study of motion yields the opposite result: motion never stops. In fact, several aspects of motion do not change, but are *conserved*: energy with mass, momentum and angular momentum are conserved in all examples of motion. No exception to conservation has ever been found. In addition, we will discover that conservation implies that motion and its properties are the same at all places and all times: motion is *universal*.
3. We all know that motion differs from rest. Nevertheless, careful study shows that there is no intrinsic difference between the two. Motion and rest depend on the observer. Motion is *relative*. This is the first step towards understanding the theory of relativity.
4. We all observe that many processes happen only in one direction. For example, spilled milk never returns into the container by itself. Nevertheless, the study of motion will show us that all everyday motion is *reversible*. Physicists call this the invariance of everyday motion under motion reversal (or, sloppily, under time reversal).
5. Most of us find scissors difficult to handle with the left hand, have difficulties to write with the other hand, and have grown with a heart on the left side. Nevertheless, our exploration will show that everyday motion is *mirror-invariant* or *parity-invariant*. Mirror processes are always possible in everyday life.
6. We all are astonished by the many observations that the world offers: colours, shapes, sounds, growth, disasters, happiness, friendship, love. The variation, beauty and complexity of nature is amazing. But despite all appearance, all motion is simple. Our study will uncover that all observations can be summarized in a simple way: all motion happens in a way that *minimizes change*. Change can be measured, and nature

---

distinction between the object and its state; the distinction itself does not disappear – at least not for quite a while.



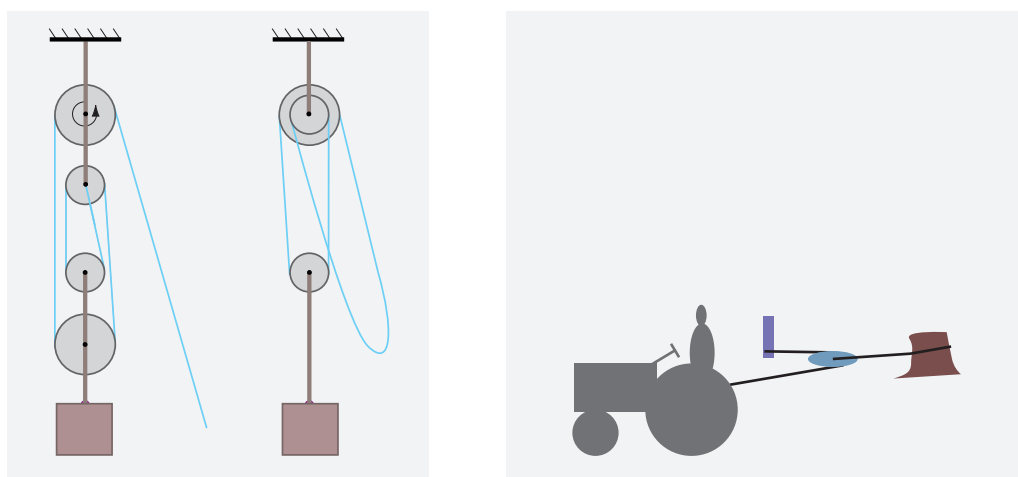


FIGURE 12 A block and tackle and a differential pulley (left) and a farmer (right).

keeps it to a minimum. Situations – or states, as physicists like to say – evolve by minimizing change.

These six aspects are essential in understanding motion in sport, in music, in animals, in machines and among the stars. This first volume of our adventure will be an exploration of such movements. In particular, we will confirm the mentioned six key properties of everyday motion: continuity, conservation, reversibility, mirror-invariance, relativity and minimization.

### CURIOSITIES AND FUN CHALLENGES ABOUT MOTION\*

In contrast to most animals, sedentary creatures, like plants or sea anemones, have no legs and cannot move much; for their self-defence, they developed *poisons*. Examples of such plants are the stinging nettle, the tobacco plant, digitalis, belladonna and poppy; poisons include caffeine, nicotine, and curare. Poisons such as these are at the basis of most medicines. Therefore, most medicines exist essentially because plants have no legs.

\* \*

A man climbs a mountain from 9 a.m. to 1 p.m. He sleeps on the top and comes down the next day, taking again from 9 a.m. to 1 p.m. for the descent. Is there a place on the path that he passes at the same time on the two days?

Challenge 10 s

\* \*

Every time a soap bubble bursts, the motion of the surface during the burst is the same, even though it is too fast to be seen by the naked eye. Can you imagine the details?

Challenge 11 s

\* \*

Is the motion of a ghost an example of motion?

Challenge 12 s

\* Sections entitled 'curiosities' are collections of topics and problems that allow one to check and to expand the usage of concepts already introduced.



\* \*

Challenge 13 s Can something stop moving? How would you show it?

\* \*

Challenge 14 s Does a body moving forever in a straight line show that nature or space is infinite?

\* \*

Challenge 15 s What is the length of rope one has to pull in order to lift a mass by a height  $h$  with a block and tackle with four wheels, as shown on the left of Figure 12? Does the farmer on the right of the figure do something sensible?

\* \*

Challenge 16 s Can the universe move?

\* \*

Challenge 17 s To talk about precision with precision, we need to measure precision itself. How would you do that?

\* \*

Challenge 18 s Would we observe motion if we had no memory?

\* \*

Challenge 19 s What is the lowest speed you have observed? Is there a lowest speed in nature?

\* \*

Challenge 20 s According to legend, Sissa ben Dahir, the Indian inventor of the game of *chaturanga* or chess, demanded from King Shirham the following reward for his invention: he wanted one grain of wheat for the first square, two for the second, four for the third, eight for the fourth, and so on. How much time would all the wheat fields of the world take to produce the necessary grains?

\* \*

Challenge 21 s When a burning candle is moved, the flame lags behind the candle. How does the flame behave if the candle is inside a glass, still burning, and the glass is accelerated?

\* \*

Challenge 22 d A good way to make money is to build motion detectors. A motion detector is a small box with a few wires. The box produces an electrical signal whenever the box moves. What types of motion detectors can you imagine? How cheap can you make such a box? How precise?

\* \*

Challenge 23 d A perfectly frictionless and spherical ball lies near the edge of a perfectly flat and horizontal table, as shown in Figure 13. What happens? In what time scale?

\* \*



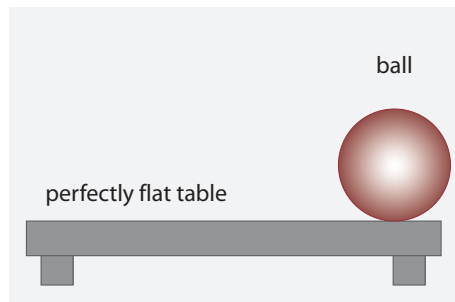


FIGURE 13 What happens?

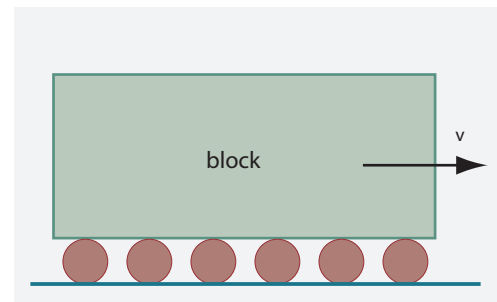


FIGURE 14 What is the speed of the rollers? Are other roller shapes possible?

Challenge 24 s You step into a closed box without windows. The box is moved by outside forces unknown to you. Can you determine *how* you are moving from inside the box?

\* \*

Challenge 25 s When a block is rolled over the floor over a set of cylinders, as shown in Figure 14, how are the speed of the block and that of the cylinders related?

\* \*

Ref. 18 Do you dislike formulae? If you do, use the following three-minute method to change  
Challenge 26 s the situation. It is worth trying it, as it will make you enjoy this book much more. Life is short; as much of it as possible, like reading this text, should be a pleasure.

1. Close your eyes and recall an experience that was *absolutely marvellous*, a situation when you felt excited, curious and positive.
2. Open your eyes for a second or two and look at page 227 – or any other page that contains many formulae.
3. Then close your eyes again and return to your marvellous experience.
4. Repeat the observation of the formulae and the visualization of your memory – steps 2 and 3 – three more times.

Then leave the memory, look around yourself to get back into the here and now, and test yourself. Look again at page 227. How do you feel about formulae now?

\* \*

Challenge 27 s In the sixteenth century, Niccolò Tartaglia\* proposed the following problem. Three young couples want to cross a river. Only a small boat that can carry two people is available. The men are extremely jealous, and would never leave their brides with another man. How many journeys across the river are necessary?

\* \*

Cylinders can be used to roll a flat object over the floor, as shown in Figure 14. The cylinders keep the object plane always at the same distance from the floor. What cross-sections *other* than circular, so-called *curves of constant width*, can a cylinder have to realize the

\* Niccolò Fontana Tartaglia (1499–1557), important Renaissance mathematician.



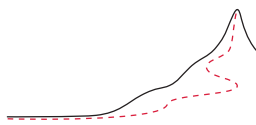
Challenge 28 s same feat? How many examples can you find? Are objects different than cylinders possible?

### SUMMARY ON MOTION

Motion is the most fundamental observation in nature. Everyday motion is predictable or deterministic. Predictability is reflected in six aspects of motion: continuity, conservation, reversibility, mirror-invariance, relativity and minimization. Some of these aspects are valid for all motion, and some are valid only for everyday motion. Which ones, and why? We explore this now.

Challenge 29 d





## CHAPTER 2

# FROM MOTION MEASUREMENT TO CONTINUITY

“Physic ist wahrlich das eigentliche Studium des Menschen.\*”

Georg Christoph Lichtenberg

Challenge 30 s

The simplest description of motion is the one we all, like cats or monkeys, use unconsciously in everyday life: *only one thing can be at a given spot at a given time*. This general description can be separated into three assumptions: matter is *impenetrable* and *moves*, time is made of *instants*, and space is made of *points*. Without these three assumptions (do you agree with them?) it is not possible to define velocity in everyday life. This description of nature is called *Galilean physics*, or sometimes *Newtonian physics*.

Galileo Galilei (1564–1642), Tuscan professor of mathematics, was a founder of modern physics and is famous for advocating the importance of observations as checks of statements about nature. By requiring and performing these checks throughout his life, he was led to continuously increase the accuracy in the description of motion. For example, Galileo studied motion by measuring change of position with a self-constructed stopwatch. His approach changed the speculative description of ancient Greece into the experimental physics of Renaissance Italy.\*\*

The English alchemist, occultist, theologian, physicist and politician Isaac Newton (1643–1727) was one of the first to pursue with vigour the idea that different types of motion have the same properties, and he made important steps in constructing the concepts necessary to demonstrate this idea.\*\*\*

The explorations by Galileo and his predecessors provided the first clear statements on the properties of speed, space and time.

---

\* ‘Physics truly is the proper study of man.’ Georg Christoph Lichtenberg (1742–1799) was an important physicist and essayist.

\*\* The best and most informative book on the life of Galileo and his times is by Pietro Redondi (see the section on [page 265](#)). Galileo was born in the year the pencil was invented. Before his time, it was impossible to do paper and pencil calculations. For the curious, the [www.mpiwg-berlin.mpg.de](http://www.mpiwg-berlin.mpg.de) website allows you to read an original manuscript by Galileo.

Ref. 25 \*\*\* Newton was born a year after Galileo died. Newton’s other hobby, as master of the Mint, was to supervise personally the hanging of counterfeiters. About Newton’s infatuation with alchemy, see the books by Dobbs. Among others, Newton believed himself to be chosen by god; he took his Latin name, *Isaacus Neuutonus*, and formed the anagram *Jeova sanctus unus*. About Newton and his importance for classical mechanics, see

Ref. 26 the text by Clifford Truesdell.





FIGURE 15 Galileo Galilei (1564–1642).



FIGURE 16 Some speed measurement devices: an anemometer, a tachymeter for inline skates, a sport radar gun and a Pitot–Prandtl tube in an aeroplane (© Fachhochschule Koblenz, Silva, Tracer, Wikimedia).

### WHAT IS VELOCITY?

“There is nothing else like it.”  
Jochen Rindt\*

Velocity fascinates. To physicists, not only car races are interesting, but any moving entity is. Therefore they first measure as many examples as possible. A selection is given in Table 3. The units and prefixes used are explained in detail in Appendix B.

Page 73

Everyday life teaches us a lot about motion: objects can overtake each other, and they can move in different directions. We also observe that velocities can be added or changed smoothly. The precise list of these properties, as given in Table 4, is summarized by mathematicians in a special term; they say that velocities form a *Euclidean vector space*.\*\* More details about this strange term will be given shortly. For now we just note that in describing nature, mathematical concepts offer the most accurate vehicle.

When velocity is assumed to be an Euclidean vector, it is called *Galilean velocity*. Velocity is a profound concept. For example, velocity does not need space and time measurements to be defined. Are you able to find a means of measuring velocities without

\* Jochen Rindt (1942–1970), famous Austrian Formula One racing car driver, speaking about speed.

\*\* It is named after Euclid, or Eukleides, the great Greek mathematician who lived in Alexandria around 300 BCE. Euclid wrote a monumental treatise of geometry, the *Στοιχεῖα* or *Elements*, which is one of the milestones of human thought. The text presents the whole knowledge on geometry of that time. For the first time, Euclid introduces two approaches that are now in common use: all statements are deduced from a small number of basic *axioms* and for every statement a *proof* is given. The book, still in print today, has been the reference geometry text for over 2000 years. On the web, it can be found at [aleph0.clarku.edu/~djoyce/java/elements/elements.html](http://aleph0.clarku.edu/~djoyce/java/elements/elements.html).





TABLE 3 Some measured velocity values.

OBSERVATION	VELOCITY
Growth of deep sea manganese crust	80 am/s
Can you find something slower?	Challenge 31 s
Stalagmite growth	0.3 pm/s
Lichen growth	down to 7 pm/s
cm Typical motion of continents	10 mm/a = 0.3 nm/s
Human growth during childhood, hair growth	4 nm/s
Tree growth	up to 30 nm/s
Electron drift in metal wire	1 $\mu$ m/s
Sperm motion	60 to 160 $\mu$ m/s
Speed of light at Sun's centre	0.1 mm/s
Ketchup motion	1 mm/s
Slowest speed of light measured in matter on Earth Ref. 27	0.3 m/s
Speed of snowflakes	0.5 m/s to 1.5 m/s
Signal speed in human nerve cells Ref. 28	0.5 m/s to 120 m/s
Wind speed at 1 Beaufort (light air)	below 1.5 m/s
Speed of rain drops, depending on radius	2 m/s to 8 m/s
Fastest swimming fish, sailfish ( <i>Istiophorus platypterus</i> )	22 m/s
2006 Speed sailing record over 500 m (by windsurfer Finian Maynard)	25.1 m/s
2008 Speed sailing record over 500 m (by kitesurfer Alex Caizergues)	26.0 m/s
2009 Speed sailing record over 500 m (by trimaran Hydroptère)	26.4 m/s
Fastest running animal, cheetah ( <i>Acinonyx jubatus</i> )	30 m/s
Wind speed at 12 Beaufort (hurricane)	above 33 m/s
Speed of air in throat when sneezing	42 m/s
Fastest throw: a cricket ball thrown with baseball technique while running	50 m/s
Freely falling human, depending on clothing	50 to 90 m/s
Fastest bird, diving <i>Falco peregrinus</i>	60 m/s
Fastest badminton serve	70 m/s
Average speed of oxygen molecule in air at room temperature	280 m/s
Speed of sound in dry air at sea level and standard temperature	330 m/s
Cracking whip's end	750 m/s
Speed of a rifle bullet	1 km/s
Speed of crack propagation in breaking silicon	5 km/s
Highest macroscopic speed achieved by man – the <i>Voyager</i> satellite	14 km/s
Speed of Earth through universe	370 km/s
Average speed (and peak speed) of lightning tip	600 km/s (50 Mm/s)
Highest macroscopic speed measured in our galaxy Ref. 29	$0.97 \cdot 10^8$ m/s
Speed of electrons inside a colour TV	$1 \cdot 10^8$ m/s
Speed of radio messages in space	299 792 458 m/s
Highest ever measured group velocity of light	$10 \cdot 10^8$ m/s
Speed of light spot from a light tower when passing over the Moon	$2 \cdot 10^9$ m/s
Highest proper velocity ever achieved for electrons by man	$7 \cdot 10^{13}$ m/s
Highest possible velocity for a light spot or shadow	no limit



TABLE 4 Properties of everyday – or Galilean – velocity.

VELOCITIES CAN	PHYSICAL PROPERTY	MATHEMATICAL NAME	DEFINITION
Be distinguished	distinguishability	element of set	Vol. III, page 195
Change gradually	continuum	real vector space	Page 73, Vol. V, page 284
Point somewhere	direction	vector space, dimensionality	Page 73
Be compared	measurability	metricity	Vol. V, page 276
Be added	additivity	vector space	Page 73
Have defined angles	direction	Euclidean vector space	Page 73
Exceed any limit	infinity	unboundedness	Vol. III, page 196

Challenge 32 d measuring space and time? If so, you probably want to skip to the next volume, jumping 2000 years of enquiries. If you cannot do so, consider this: whenever we measure a quantity we assume that everybody is able to do so, and that everybody will get the same result. In other words, we define *measurement* as a comparison with a standard. We thus implicitly assume that such a standard exists, i.e., that an example of a ‘perfect’ velocity can be found. Historically, the study of motion did not investigate this question first, because for many centuries nobody could find such a standard velocity. You are thus in good company.

Ref. 30 Some researchers have specialized in the study of the lowest velocities found in nature: they are called geologists. Do not miss the opportunity to walk across a landscape while listening to one of them.

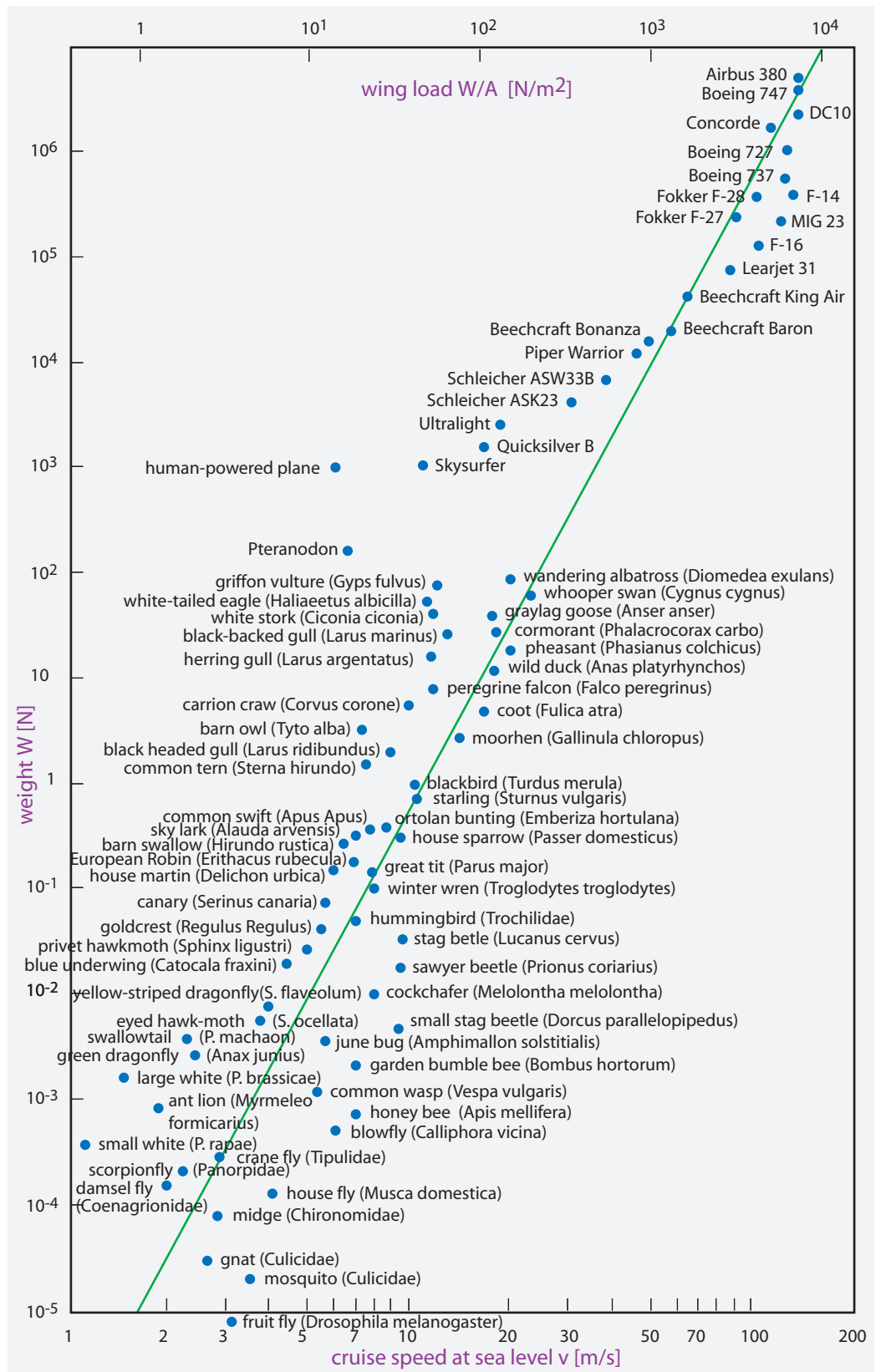
Challenge 33 s Velocity is not always an easy subject. Physicists like to say, provokingly, that what cannot be measured does not exist. Can one’s own velocity in empty interstellar space be measured?

How is velocity measured in everyday life? Animals and people estimate their velocity in two ways: by estimating the frequency of their own movements, such as their steps, or by using their eyes, ears, sense of touch or sense of vibration to deduce how their own position changes with respect to the environment. But several animals have additional capabilities: certain snakes can determine speeds with their infrared-sensing organs, others with their magnetic field sensing organs. Still other animals emit sounds that create echoes in order to measure speeds to high precision. The same range of solutions is used by technical devices.

Challenge 34 d Velocity is of interest to both engineers and evolution. In general, self-propelled systems are faster the larger they are. As an example, Figure 17 shows how this applies to the cruise speed of flying things. In general, cruise speed scales with the sixth root of the weight, as shown by the trend line drawn in the graph. (Can you find out why?) By the way, similar *allometric scaling* relations hold for many other properties of moving systems, as we will see later on.

Velocity is a profound subject for an additional reason: we will discover that all seven properties of Table 4 are only approximate; *none* is actually correct. Improved experiments will uncover exceptions for every property of Galilean velocity. The failure of the last three properties of Table 4 will lead us to special and general relativity, the failure of





Motion Mountain - The Adventure of Physics pdf file available free of charge at www.motionmountain.net Copyright © Christoph Schiller November 1997-June 2011

FIGURE 17 How wing load and sea-level cruise speed scales with weight in flying objects, compared with the general trend line (after a graph © Henk Tennekes).

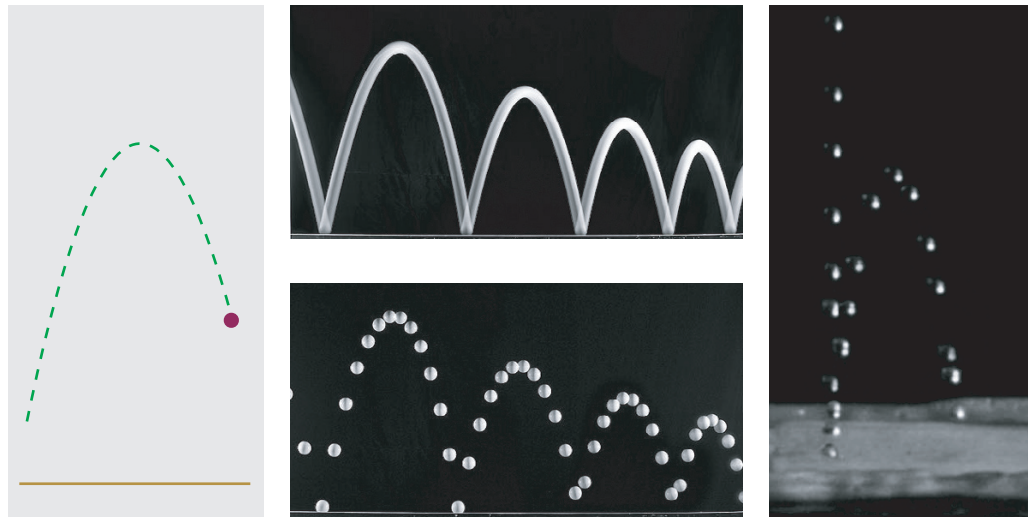


TABLE 5 Speed measurement devices in biological and engineered systems.

MEASUREMENT	DEVICE	RANGE
Own running speed in insects, mammals and humans	leg beat frequency measured with internal clock	0 to 33 m/s
Own car speed	tachymeter attached to wheels	0 to 150 m/s
Predators and hunters measuring prey speed	vision system	0 to 30 m/s
Police measuring car speed	radar or laser gun	0 to 90 m/s
Bat measuring own and prey speed at night	doppler sonar	0 to 20 m/s
Sliding door measuring speed of approaching people	doppler radar	0 to 3 m/s
Own swimming speed in fish and humans	friction and deformation of skin	0 to 30 m/s
Own swimming speed in dolphins and ships	sonar to sea floor	0 to 20 m/s
Diving speed in fish, animals, divers and submarines	pressure change	0 to 5 m/s
Water predators and fishing boats measuring prey speed	sonar	0 to 20 m/s
Own speed relative to Earth in insects	often none (grasshoppers)	n.a.
Own speed relative to Earth in birds	visual system	0 to 60 m/s
Own speed relative to Earth in aeroplanes or rockets	radio goniometry, radar	0 to 8000 m/s
Own speed relative to air in insects and birds	filiform hair deflection, feather deflection	0 to 60 m/s
Own speed relative to air in aeroplanes	Pitot-Prandtl tube	0 to 340 m/s
Wind speed measurement in meteorological stations	thermal, rotating or ultrasound anemometers	0 to 80 m/s
Swallows measuring prey speed	visual system	0 to 20 m/s
Bats measuring prey speed	sonar	0 to 20 m/s
Macroscopic motion on Earth	Global Positioning System, Galileo, Glonass	0 to 100 m/s
Pilots measuring target speed	radar	0 to 1000 m/s
Motion of stars	optical Doppler effect	0 to 1000 km/s
Motion of star jets	optical Doppler effect	0 to 200 Mm/s

the middle two to quantum theory and the failure of the first two properties to the unified description of nature. But for now, we'll stick with Galilean velocity, and continue with another Galilean concept derived from it: time.





**FIGURE 18** A typical path followed by a stone thrown through the air – a parabola – with photographs (blurred and stroboscopic) of a table tennis ball rebounding on a table and a stroboscopic photograph of a water droplet rebounding on a strongly hydrophobic surface (© Andrew Davidhazy, Max Groenendijk).

“Without the concepts *place*, *void* and *time*, change cannot be. [...] It is therefore clear [...] that their investigation has to be carried out, by studying each of them separately.”  
Aristotle\* *Physics*, Book III, part 1.

### WHAT IS TIME?

“Time does not exist in itself, but only through the perceived objects, from which the concepts of past, of present and of future ensue.”  
Lucretius,\*\* *De rerum natura*, lib. 1, v. 460 ss.

Ref. 21

In their first years of life, children spend a lot of time throwing objects around. The term ‘object’ is a Latin word meaning ‘that which has been thrown in front.’ Developmental psychology has shown experimentally that from this very experience children extract the concepts of time and space. Adult physicists do the same when studying motion at university.

When we throw a stone through the air, we can define a *sequence* of observations. Our memory and our senses give us this ability. The sense of hearing registers the various sounds during the rise, the fall and the landing of the stone. Our eyes track the location of the stone from one point to the next. All observations have their place in a sequence, with some observations preceding them, some observations simultaneous to them, and still others succeeding them. We say that observations are perceived to happen at various *instants* and we call the sequence of all instants *time*.

\* Aristotle (384/3–322 BCE), Greek philosopher and scientist.

\*\* Titus Lucretius Carus (c. 95 to c. 55 BCE), Roman scholar and poet.



TABLE 6 Selected time measurements.

OBSERVATION	TIME
Shortest measurable time	$10^{-44}$ s
Shortest time ever measured	10 ys
Time for light to cross a typical atom	0.1 to 10 as
Shortest laser light pulse produced so far	200 as
Period of caesium ground state hyperfine transition	108.782 775 707 78 ps
Beat of wings of fruit fly	1 ms
Period of pulsar (rotating neutron star) PSR 1913+16	0.059 029 995 271(2) s
Human 'instant'	20 ms
Shortest lifetime of living being	0.3 d
Average length of day 400 million years ago	79 200 s
Average length of day today	86 400.002(1) s
From birth to your 1000 million seconds anniversary	31.7 a
Age of oldest living tree	4600 a
Use of human language	0.2 Ma
Age of Himalayas	35 to 55 Ma
Age of oldest rocks, found in Isua Belt, Greenland and in Porpoise Cove, Hudson Bay	3.8 Ga
Age of Earth	4.6 Ga
Age of oldest stars	13.7 Ga
Age of most protons in your body	13.7 Ga
Lifetime of tantalum nucleus $^{180m}\text{Ta}$	$10^{15}$ a
Lifetime of bismuth $^{209}\text{Bi}$ nucleus	$1.9(2) \cdot 10^{19}$ a

Challenge 35 s An observation that is considered the smallest part of a sequence, i.e., not itself a sequence, is called an *event*. Events are central to the definition of time; in particular, starting or stopping a stopwatch are events. (But do events really exist? Keep this question in the back of your head as we move on.)

Sequential phenomena have an additional property known as stretch, extension or duration. Some measured values are given in Table 6.\* *Duration* expresses the idea that sequences *take* time. We say that a sequence takes time to express that other sequences can take place in parallel with it.

Ref. 21 How exactly is the concept of time, including sequence and duration, deduced from observations? Many people have looked into this question: astronomers, physicists, watchmakers, psychologists and philosophers. All find that *time is deduced by comparing motions*. Children, beginning at a very young age, develop the concept of 'time' from the comparison of motions in their surroundings. Grown-ups take as a standard the motion of the Sun and call the resulting type of time *local time*. From the Moon they deduce a *lunar calendar*. If they take a particular village clock on a European island they call it the

\* A year is abbreviated a (Latin 'annus').



*universal time coordinate* (UTC), once known as ‘Greenwich mean time.’\* Astronomers use the movements of the stars and call the result *ephemeris time* (or one of its successors). An observer who uses his personal watch calls the reading his *proper time*; it is often used in the theory of relativity.

Page 350 Not every movement is a good standard for time. In the year 2000 an Earth rotation did not take 86 400 seconds any more, as it did in the year 1900, but 86 400.002 seconds. Can you deduce in which year your birthday will have shifted by a whole day from the time predicted with 86 400 seconds?

Challenge 37 s

All methods for the definition of time are thus based on comparisons of motions. In order to make the concept as precise and as useful as possible, a *standard* reference motion is chosen, and with it a standard sequence and a standard duration is defined. The device that performs this task is called a *clock*. We can thus answer the question of the section title:

▷ *Time is what we read from a clock.*

Note that all definitions of time used in the various branches of physics are equivalent to this one; no ‘deeper’ or more fundamental definition is possible.\*\* Note that the word ‘moment’ is indeed derived from the word ‘movement’. Language follows physics in this case. Astonishingly, the definition of time just given is final; it will never be changed, not even at the top of Motion Mountain. This is surprising at first sight, because many books have been written on the nature of time. Instead, they should investigate the nature of motion! But this is the aim of our walk anyhow. We are thus set to discover all the secrets of time as a side result of our adventure. Every clock reminds us that in order to understand time, we need to understand motion.

Challenge 38 s

A *clock* is thus a moving system whose position can be read. Of course, a *precise* clock is a system moving as regularly as possible, with as little outside disturbance as possible. Is there a perfect clock in nature? Do clocks exist at all? We will continue to study these questions throughout this work and eventually reach a surprising conclusion. At this point, however, we state a simple intermediate result: since clocks do exist, somehow there is in nature an intrinsic, natural and *ideal* way to measure time. Can you see it?

Time is not only an aspect of observations, it is also a facet of personal experience. Even in our innermost private life, in our thoughts, feelings and dreams, we experience sequences and durations. Children learn to relate this internal experience of time with external observations, and to make use of the sequential property of events in their actions. Studies of the origin of psychological time show that it coincides – apart from its lack of accuracy – with clock time.\*\*\* Every living human necessarily uses in his daily

Challenge 36 s

\* Official UTC is used to determine the phase of the power grid, phone companies’ bit streams and the signal to the GPS system. The latter is used by many navigation systems around the world, especially in ships, aeroplanes and lorries. For more information, see the [www.gpsworld.com](http://www.gpsworld.com) website. The time-keeping infrastructure is also important for other parts of the modern economy. Can you spot the most important ones?

Ref. 31  
Vol. V, page 31

\*\* The oldest clocks are sundials. The science of making them is called *gnomonics*.

Ref. 32

\*\*\* The brain contains numerous clocks. The most precise clock for short time intervals, the internal interval timer of the brain, is more accurate than often imagined, especially when trained. For time periods between a few tenths of a second, as necessary for music, and a few minutes, humans can achieve timing accuracies





TABLE 7 Properties of Galilean time.

INSTANTS OF TIME	PHYSICAL PROPERTY	MATHEMATICAL NAME	DEFINITION
Can be distinguished	distinguishability	element of set	Vol. III, page 195
Can be put in order	sequence	order	Vol. V, page 284
Define duration	measurability	metricity	Vol. V, page 276
Can have vanishing duration	continuity	denseness, completeness	Vol. V, page 284
Allow durations to be added	additivity	metricity	Vol. V, page 276
Don't harbour surprises	translation invariance	homogeneity	Page 191
Don't end	infinity	unboundedness	Vol. III, page 196
Are equal for all observers	absoluteness	uniqueness	

life the concept of time as a combination of sequence and duration; this fact has been checked in numerous investigations. For example, the term 'when' exists in all human languages.

Ref. 33

Time is a concept *necessary* to distinguish between observations. In any sequence, we observe that events succeed each other smoothly, apparently without end. In this context, 'smoothly' means that observations that are not too distant tend to be not too different. Yet between two instants, as close as we can observe them, there is always room for other events. Durations, or *time intervals*, measured by different people with different clocks agree in everyday life; moreover, all observers agree on the order of a sequence of events. Time is thus unique in everyday life.

Vol. III, page 204

The mentioned properties of everyday time, listed in Table 7, correspond to the precise version of our everyday experience of time. It is called *Galilean time*; all the properties can be expressed simultaneously by describing time with the help of real numbers. In fact, real numbers have been constructed by mathematicians to have exactly the same properties as Galilean time, as explained in the chapter on the brain. Every instant of time can be described by a real number, often abbreviated  $t$ , and the duration of a sequence of events is given by the difference between the values for the final and the starting event.

Challenge 39 s

When Galileo studied motion in the seventeenth century, there were as yet no stopwatches. He thus had to build one himself, in order to measure times in the range between a fraction and a few seconds. Can you imagine how he did it?

We will have quite some fun with Galilean time in this part of our adventure. However, hundreds of years of close scrutiny have shown that *every single* property of time just listed is approximate, and none is strictly correct. This story is told in the rest of our adventure.

## CLOCKS

Ref. 34

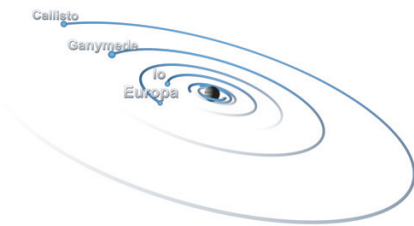
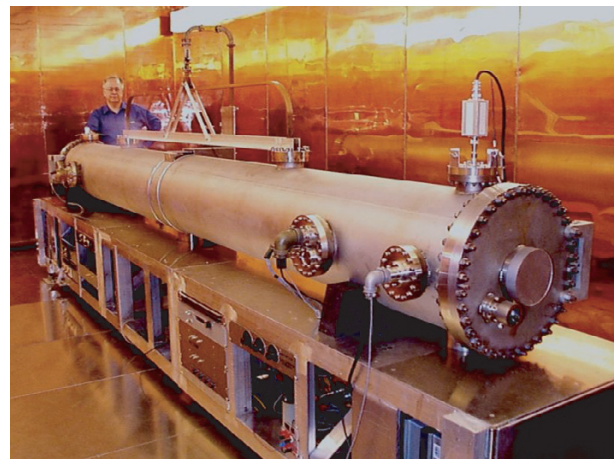
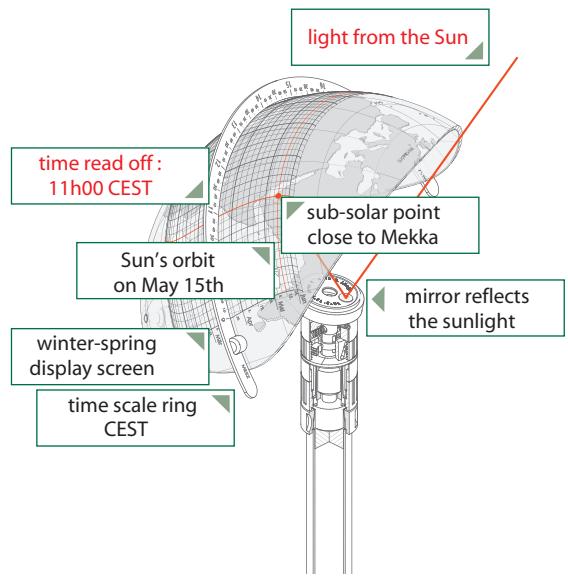
A *clock* is a moving system whose position can be read. There are many types of clocks: stopwatches, twelve-hour clocks, sundials, lunar clocks, seasonal clocks, etc. Almost all clock types are also found in plants and animals, as shown in Table 8.

---

of a few per cent.







**FIGURE 19** Different types of clocks: a high-tech sundial (size c. 30 cm), a naval pocket chronometer (size c. 6 cm), a caesium atomic clock (size c. 4 m), a group of cyanobacteria and the Galilean satellites of Jupiter (© Carlo Heller at [www.heliosuhren.de](http://www.heliosuhren.de), Anonymous, INMS, Wikimedia, NASA).



TABLE 8 Examples of biological rhythms and clocks.

LIVING BEING	OSCILLATING SYSTEM	PERIOD
Sand hopper ( <i>Talitrus saltator</i> )	knows in which direction to flee from the position of the Sun or Moon	circadian
Human ( <i>Homo sapiens</i> )	gamma waves in the brain	0.023 to 0.03 s
	alpha waves in the brain	0.08 to 0.13 s
	heart beat	0.3 to 1.5 s
	delta waves in the brain	0.3 to 10 s
	blood circulation	30 s
	cellular circathal rhythms	1 to 2 ks
	rapid-eye-movement sleep period	5.4 ks
	nasal cycle	4 to 14 ks
	growth hormone cycle	11 ks
	suprachiasmatic nuclei (SCN), circadian hormone concentration, temperature, etc.; leads to jet lag	90 ks
	monthly period	2.4(4) Ms
built-in aging	3.2(3) Gs	
Common fly ( <i>Musca domestica</i> )	wing beat	30 ms
Fruit fly ( <i>Drosophila melanogaster</i> )	wing beat for courting	34 ms
Most insects (e.g. wasps, fruit flies)	winter approach detection (diapause) by length of day measurement; triggers metabolism changes	yearly
Algae ( <i>Acetabularia</i> )	Adenosinetriphosphate (ATP) concentration	
Moulds (e.g. <i>Neurospora crassa</i> )	conidia formation	circadian
Many flowering plants	flower opening and closing	circadian
Tobacco plant	flower opening clock; triggered by length of days, discovered in 1920 by Garner and Allard	annual
<i>Arabidopsis</i>	circumnutation	circadian
	growth	a few hours
Telegraph plant ( <i>Desmodium gyrans</i> )	side leaf rotation	200 s
<i>Forsythia europaea</i> , <i>F. suspensa</i> , <i>F. viridissima</i> , <i>F. spectabilis</i>	Flower petal oscillation, discovered by Van Gooch in 2002	5.1 ks

Ref. 35 Interestingly, there is a strict rule in the animal kingdom: large clocks go slow. How this happens, is shown in Figure 20, another example of an *allometric scaling* 'law'.

Page 144 Clock makers are experts in producing motion that is as regular as possible. We will discover some of their tricks below. We will also explore, later on, the fundamental limits  
Vol. V, page 34 for the precision of clocks.



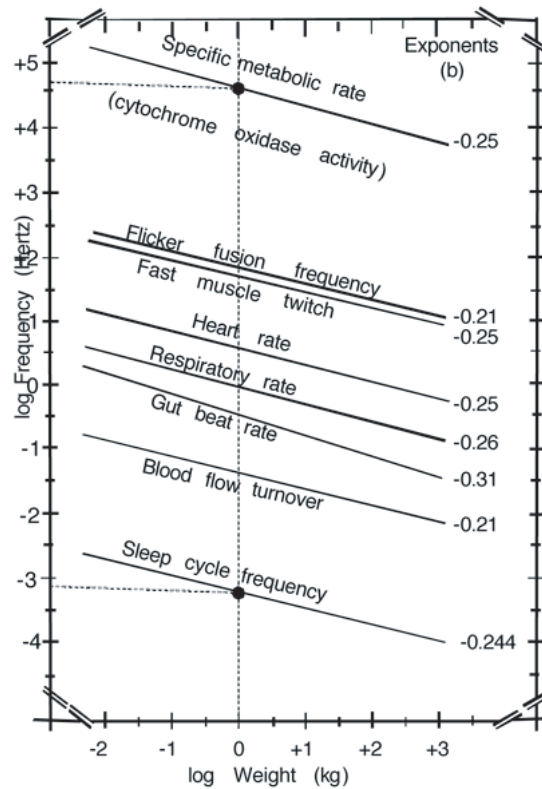


FIGURE 20 How biological rhythms scale with size in mammals (© Enrique Morgado).

### WHY DO CLOCKS GO CLOCKWISE?

Challenge 40 s

☞ What time is it at the North Pole now?

Most rotational motions in our society, such as athletic races, horse, bicycle or ice skating races, turn anticlockwise.\* Likewise, every supermarket leads its guests anticlockwise through the hall. Mathematicians call this the positive rotation sense. Why? Most people are right-handed, and the right hand has more freedom at the outside of a circle. Therefore thousands of years ago chariot races in stadia went anticlockwise. As a result, all stadium races still do so to this day, and that is why runners move anticlockwise. For the same reason, helical stairs in castles are built in such a way that defending right-handers, usually from above, have that hand on the outside.

On the other hand, the clock imitates the shadow of sundials; obviously, this is true on the northern hemisphere only, and only for sundials on the ground, which were the most common ones. (The old trick to determine south by pointing the hour hand of a horizontal watch to the Sun and halving the angle between it and the direction of 12 o'clock does not work on the southern hemisphere.) So every clock implicitly continues to state on which hemisphere it was invented. In addition, it also tells us that sundials on walls came in use much later than those on the floor.

\* Notable exceptions are most, but not all, Formula 1 races.



## DOES TIME FLOW?

“ Wir können keinen Vorgang mit dem ‘Ablauf der Zeit’ vergleichen – diesen gibt es nicht –, sondern nur mit einem anderen Vorgang (etwa dem Gang des Chronometers).\*  
Ludwig Wittgenstein, *Tractatus*, 6.3611 ”

“ Si le temps est un fleuve, quel est son lit? \*\* ”

The expression ‘the flow of time’ is often used to convey that in nature change follows after change, in a steady and continuous manner. But though the hands of a clock ‘flow’, time itself does not. Time is a concept introduced specially to describe the flow of events around us; it does not itself flow, it *describes* flow. Time does not advance. Time is neither linear nor cyclic. The idea that time flows is as hindering to understanding nature as is the idea that mirrors exchange right and left.

Vol. III, page 76

The misleading use of the expression ‘flow of time’, propagated first by some flawed Greek thinkers and then again by Newton, continues. Aristotle (384/3–322 BCE), careful to think logically, pointed out its misconception, and many did so after him. Nevertheless, expressions such as ‘time reversal’, the ‘irreversibility of time’, and the much-abused ‘time’s arrow’ are still common. Just read a popular science magazine chosen at random.

Ref. 36

Challenge 41 e

The fact is: time cannot be reversed, only motion can, or more precisely, only velocities of objects; time has no arrow, only motion has; it is not the flow of time that humans are unable to stop, but the motion of all the objects in nature. Incredibly, there are even books written by respected physicists that study different types of ‘time’s arrows’ and compare them with each other. Predictably, no tangible or new result is extracted. Time does not flow.

Ref. 37

In the same manner, colloquial expressions such as ‘the start (or end) of time’ should be avoided. A motion expert translates them straight away into ‘the start (or end) of motion’.

## WHAT IS SPACE?

“ The introduction of numbers as coordinates [...] is an act of violence [...].  
Hermann Weyl, *Philosophie der Mathematik und Naturwissenschaft*.\*\*\* ”

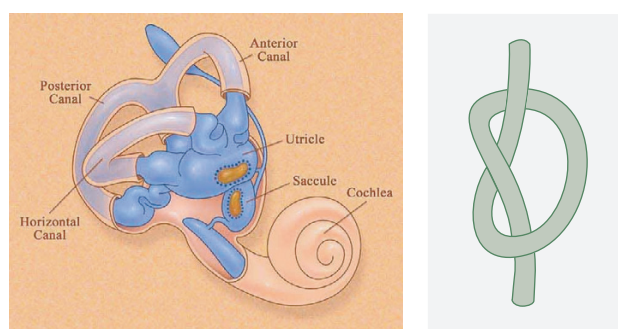
Whenever we distinguish two objects from each other, such as two stars, we first of all distinguish their positions. We distinguish positions with our senses of sight, touch, hearing and proprioception. Position is therefore an important aspect of the physical state of an object. A position is taken by only one object at a time. Positions are limited. The set of

\* ‘We cannot compare any process with ‘the passage of time’ – there is no such thing – but only with another process (say, with the working of a chronometer).’

\*\* ‘If time is a river, what is his bed?’

\*\*\* Hermann Weyl (1885–1955) was one of the most important mathematicians of his time, as well as an important theoretical physicist. He was one of the last universalists in both fields, a contributor to quantum theory and relativity, father of the term ‘gauge’ theory, and author of many popular texts.





**FIGURE 21** Two proofs that space has three dimensions: the vestibular labyrinth in the inner ear of mammals (here a human) and a knot (© Northwestern University).

all available positions, called (*physical*) *space*, acts as both a container and a background.

Closely related to space and position is *size*, the set of positions an object occupies. Small objects occupy only subsets of the positions occupied by large ones. We will discuss size shortly.

How do we deduce space from observations? During childhood, humans (and most higher animals) learn to bring together the various perceptions of space, namely the visual, the tactile, the auditory, the kinaesthetic, the vestibular etc., into one coherent set of experiences and description. The result of this learning process is a certain concept of space in the brain. Indeed, the question ‘where?’ can be asked and answered in all languages of the world. Being more precise, adults derive space from distance measurements. The concepts of length, area, volume, angle and solid angle are all deduced with their help. Geometers, surveyors, architects, astronomers, carpet salesmen and producers of metre sticks base their trade on distance measurements. Space is a concept formed to summarize all the distance relations between objects for a precise description of observations.

Metre sticks work well only if they are straight. But when humans lived in the jungle, there were no straight objects around them. No straight rulers, no straight tools, nothing. Today, a cityscape is essentially a collection of straight lines. Can you describe how humans achieved this?

#### Challenge 42 s

Once humans came out of the jungle with their newly built metre sticks, they collected a wealth of results. The main ones are listed in [Table 9](#); they are easily confirmed by personal experience. Objects can take positions in an apparently *continuous* manner: there indeed are more positions than can be counted.\* Size is captured by defining the distance between various positions, called *length*, or by using the field of view an object takes when touched, called its *surface*. Length and surface can be measured with the help of a metre stick. Selected measurement results are given in [Table 10](#). The length of objects is independent of the person measuring it, of the position of the objects and of their orientation. In daily life the sum of angles in any triangle is equal to two right angles. There are no limits in space.

Experience shows us that space has three dimensions; we can define sequences of positions in precisely three independent ways. Indeed, the inner ear of (practically) all vertebrates has three semicircular canals that sense the body’s acceleration in the three

\* For a definition of uncountability, see [page 198](#).





TABLE 9 Properties of Galilean space.

P O I N T S	P H Y S I C A L P R O P E R T Y	M A T H E M A T I C A L N A M E	D E F I N I - T I O N
Can be distinguished	distinguishability	element of set	Vol. III, page 195
Can be lined up if on one line	sequence	order	Vol. V, page 284
Can form shapes	shape	topology	Vol. V, page 283
Lie along three independent directions	possibility of knots	3-dimensionality	Page 73, Vol. V, page 276
Can have vanishing distance	continuity	denseness, completeness	Vol. V, page 284
Define distances	measurability	metricity	Vol. V, page 276
Allow adding translations	additivity	metricity	Vol. V, page 276
Define angles	scalar product	Euclidean space	Page 73
Don't harbour surprises	translation invariance	homogeneity	
Can beat any limit	infinity	unboundedness	Vol. III, page 196
Defined for all observers	absoluteness	uniqueness	Page 48

Challenge 43 s

dimensions of space, as shown in [Figure 21](#).<sup>\*</sup> Similarly, each human eye is moved by three pairs of muscles. (Why three?) Another proof that space has three dimensions is provided by shoelaces: if space had more than three dimensions, shoelaces would not be useful, because knots exist only in three-dimensional space. But why does space have three dimensions? This is one of the most difficult question of physics; it will be answered only in the very last part of our walk.

Challenge 44 s

It is often said that thinking in four dimensions is impossible. That is wrong. Just try. For example, can you confirm that in four dimensions knots are impossible?

Like time intervals, length intervals can be described most precisely with the help of *real numbers*. In order to simplify communication, standard *units* are used, so that everybody uses the same numbers for the same length. Units allow us to explore the general properties of *Galilean space* experimentally: space, the container of objects, is continuous, three-dimensional, isotropic, homogeneous, infinite, Euclidean and unique or 'absolute'. In mathematics, a structure or mathematical concept with all the properties just mentioned is called a three-dimensional *Euclidean space*. Its elements, (*mathematical*) *points*, are described by three real parameters. They are usually written as

$$(x, y, z) \tag{1}$$

and are called *coordinates*. They specify and order the location of a point in space. (For the precise definition of Euclidean spaces, see [page 73](#).)

What is described here in just half a page actually took 2000 years to be worked out, mainly because the concepts of 'real number' and 'coordinate' had to be discovered

<sup>\*</sup> Note that saying that space has three dimensions *implies* that space is continuous; the Dutch mathematician and philosopher Luitzen Brouwer (b. 1881 Overschie, d. 1966 Blaricum) showed that dimensionality is only a useful concept for continuous sets.





FIGURE 22 René Descartes (1596–1650).

first. The first person to describe points of space in this way was the famous mathematician and philosopher René Descartes\*, after whom the coordinates of expression (1) are named *Cartesian*.

Like time, space is a *necessary* concept to describe the world. Indeed, space is automatically introduced when we describe situations with many objects. For example, when many spheres lie on a billiard table, we cannot avoid using space to describe the relations between them. There is no way to avoid using spatial concepts when talking about nature.

Even though we need space to talk about nature, it is still interesting to ask why this is possible. For example, since length measurement methods do exist, there must be a *natural* or *ideal* way to measure distances, sizes and straightness. Can you find it?

Challenge 45 s

As in the case of time, each of the properties of space just listed has to be checked. And again, careful observations will show that each property is an approximation. In simpler and more drastic words, *all* of them are wrong. This confirms Weyl's statement at the beginning of this section. In fact, his statement about the violence connected with the introduction of numbers is told by every forest in the world, and of course also by the one at the foot of Motion Mountain. The rest of our adventure will show this.

“Μέτρον ἄριστον.\*\*

”  
Cleobulus

### ARE SPACE AND TIME ABSOLUTE OR RELATIVE?

In everyday life, the concepts of Galilean space and time include two opposing aspects; the contrast has coloured every discussion for several centuries. On the one hand, space and time express something invariant and permanent; they both act like big containers for all the objects and events found in nature. Seen this way, space and time have an existence of their own. In this sense one can say that they are fundamental or *absolute*. On the other hand, space and time are tools of description that allow us to talk about relations between objects. In this view, they do not have any meaning when separated from objects, and only result from the relations between objects; they are derived, relational or *relative*. Which of these viewpoints do you prefer? The results of physics have alternately favoured one viewpoint or the other. We will repeat this alternation throughout

Challenge 46 e

\* René Descartes or Cartesius (b. 1596 La Haye, d. 1650 Stockholm), French mathematician and philosopher, author of the famous statement ‘je pense, donc je suis’, which he translated into ‘cogito ergo sum’ – I think therefore I am. In his view this is the only statement one can be sure of.

\*\* ‘Measure is the best (thing):’ Cleobulus (Κλεοβουλος) of Lindos, (c. 620–550 BCE) was another of the proverbial seven sages.





TABLE 10 Some measured distance values.

OBSERVATION	DISTANCE
Galaxy Compton wavelength	$10^{-85}$ m (calculated only)
Planck length, the shortest measurable length	$10^{-32}$ m
Proton diameter	1 fm
Electron Compton wavelength	2.426 310 215(18) pm
Hydrogen atom size	30 pm
Smallest eardrum oscillation detectable by human ear	50 pm
Size of small bacterium	0.2 $\mu$ m
Wavelength of visible light	0.4 to 0.8 $\mu$ m
Point: diameter of smallest object visible with naked eye	20 $\mu$ m
Diameter of human hair (thin to thick)	30 to 80 $\mu$ m
Total length of DNA in each human cell	2 m
Largest living thing, the fungus <i>Armillaria ostoyae</i>	3 km
Longest human throw with any object, using a boomerang	427 m
Highest human-built structure, Burj Khalifa	828 m
Largest spider webs in Mexico	c. 5 km
Length of Earth's Equator	40 075 014.8(6) m
Total length of human blood vessels (rough estimate)	$4 \text{ to } 16 \cdot 10^4$ km
Total length of human nerve cells (rough estimate)	$1.5 \text{ to } 8 \cdot 10^5$ km
Average distance to Sun	149 597 870 691(30) m
Light year	9.5 Pm
Distance to typical star at night	10 Em
Size of galaxy	1 Zm
Distance to Andromeda galaxy	28 Zm
Most distant visible object	125 Ym

Ref. 38 our adventure, until we find the solution. And obviously, it will turn out to be a third option.

### SIZE – WHY AREA EXISTS, BUT VOLUME DOES NOT

A central aspect of objects is their size. As a small child, under school age, every human learns how to use the properties of size and space in their actions. As adults seeking precision, with the definition of *distance* as the difference between coordinates allows us to define *length* in a reliable way. It took hundreds of years to discover that this is *not* the case. Several investigations in physics and mathematics led to complications.

The physical issues started with an astonishingly simple question asked by Lewis Richardson:\* How long is the western coastline of Britain?

Following the coastline on a map using an odometer, a device shown in Figure 24, Richardson found that the length  $l$  of the coastline depends on the scale  $s$  (say 1:10 000

\* Lewis Fray Richardson (1881–1953), English physicist and psychologist.





**FIGURE 23** Three mechanical (a vernier caliper, a micrometer screw, a moustache) and three optical (the eyes, a laser meter, a light curtain) length and distance measurement devices (© [www.medien-werkstatt.de](http://www.medien-werkstatt.de), Naples zoo, Leica Geosystems and Keyence).

or 1 : 500 000) of the map used:

$$l = l_0 s^{0.25} \quad (2)$$

(Richardson found other numbers for other coasts.) The number  $l_0$  is the length at scale 1 : 1. The main result is that the larger the map, the longer the coastline. What would happen if the scale of the map were increased even beyond the size of the original? The length would increase beyond all bounds. Can a coastline really have *infinite* length? Yes, it can. In fact, mathematicians have described many such curves; they are called *fractals*.



TABLE 11 Length measurement devices in biological and engineered systems.

MEASUREMENT	DEVICE	RANGE
<i>Humans</i>		
Measurement of body shape, e.g. finger distance, eye position, teeth distance	muscle sensors	0.3 mm to 2 m
Measurement of object distance	stereoscopic vision	1 to 100 m
Measurement of object distance	sound echo effect	0.1 to 1000 m
<i>Animals</i>		
Measurement of walking distance by desert ants	step counter	up to 100 m
Measurement of flight distance by honey bees	eye	up to 3 km
Measurement of swimming distance by sharks	magnetic field map	up to 1000 km
Measurement of prey distance by snakes	infrared sensor	up to 2 m
Measurement of prey distance by bats, dolphins, and hump whales	sonar	up to 100 m
Measurement of prey distance by raptors	vision	0.1 to 1000 m
<i>Machines</i>		
Measurement of object distance by laser	light reflection	0.1 m to 400 Mm
Measurement of object distance by radar	radio echo	0.1 to 50 km
Measurement of object length	interferometer	0.5 $\mu\text{m}$ to 50 km
Measurement of star, galaxy or quasar distance	intensity decay	up to 125 Ym
Measurement of particle size	accelerator	down to $10^{-18}$ m

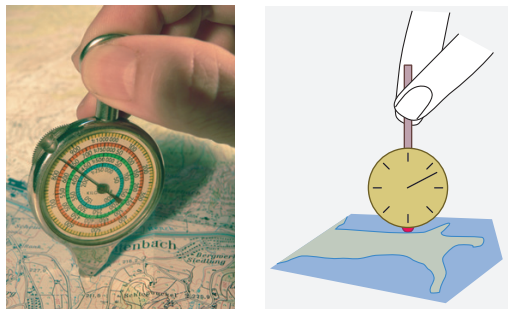


FIGURE 24 A curvimeter or odometer (photograph © Frank Müller).

An infinite number of them exist, and Figure 25 shows one example.\* Can you construct

\* Most of these curves are *self-similar*, i.e., they follow scaling 'laws' similar to the above-mentioned. The term 'fractal' is due to the Polish mathematician Benoît Mandelbrot and refers to a strange property: in a certain sense, they have a non-integral number  $D$  of dimensions, despite being one-dimensional by construction. Mandelbrot saw that the non-integer dimension was related to the exponent  $e$  of Richardson by

Ref. 39  $D = 1 + e$ , thus giving  $D = 1.25$  in the example above.



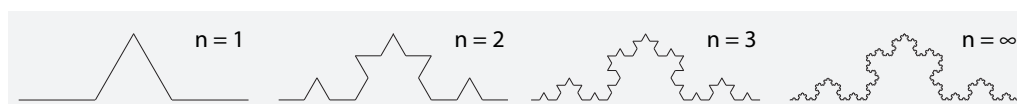


FIGURE 25 A fractal: a self-similar curve of *infinite* length (far right), and its construction.

Challenge 47 e another?

Length has other strange properties. The Italian mathematician Giuseppe Vitali was the first to discover that it is possible to cut a line segment of length 1 into pieces that can be reassembled – merely by shifting them in the direction of the segment – into a line segment of length 2. Are you able to find such a division using the hint that it is only possible using infinitely many pieces?

Challenge 48 d

To sum up, length is well defined for lines that are straight or nicely curved, but not for intricate lines, or for lines made of infinitely many pieces. We therefore avoid fractals and other strangely shaped curves in the following, and we take special care when we talk about infinitely small segments. These are the central assumptions in the first five volumes of this adventure, and we should never forget them. We will come back to these assumptions in the last volume of our adventure.

In fact, all these problems pale when compared with the following problem. Commonly, area and volume are defined using length. You think that it is easy? You're wrong, as well as being a victim of prejudices spread by schools around the world. To define area and volume with precision, their definitions must have two properties: the values must be *additive*, i.e., for finite and infinite sets of objects, the total area and volume have to be the sum of the areas and volumes of each element of the set; and they must be *rigid*, i.e., if one cuts an area or a volume into pieces and then rearranges the pieces, the value remains the same. Are such definitions possible? In other words, do such concepts of volume and area exist?

Challenge 49 s

Page 200

For areas in a plane, one proceeds in the following standard way: one defines the area  $A$  of a rectangle of sides  $a$  and  $b$  as  $A = ab$ ; since any polygon can be rearranged into a rectangle with a finite number of straight cuts, one can then define an area value for all polygons. Subsequently, one can define area for nicely curved shapes as the limit of the sum of infinitely many polygons. This method is called *integration*; it is introduced in detail in the section on physical action.

Challenge 50 s

However, integration does not allow us to define area for arbitrarily bounded regions. (Can you imagine such a region?) For a complete definition, more sophisticated tools are needed. They were discovered in 1923 by the famous mathematician Stefan Banach.\* He proved that one can indeed define an area for any set of points whatsoever, even if the border is not nicely curved but extremely complicated, such as the fractal curve previously mentioned. Today this generalized concept of area, technically a 'finitely additive isometrically invariant measure,' is called a *Banach measure* in his honour. Mathematicians sum up this discussion by saying that since in two dimensions there is a Banach measure, there is a way to define the concept of area – an additive and rigid measure – for any set of points whatsoever.\*\*

\* Stefan Banach (Krakow, 1892–Lvov, 1945), important Polish mathematician.

\*\* Actually, this is true only for sets on the plane. For curved surfaces, such as the surface of a sphere, there



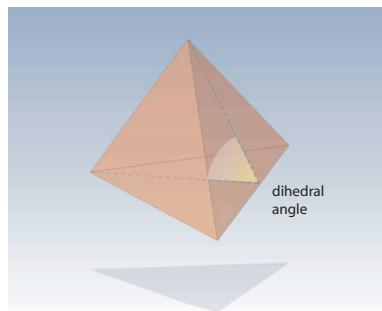


FIGURE 26 A polyhedron with one of its dihedral angles (© Luca Gastaldi).

What is the situation in *three* dimensions, i.e., for volume? We can start in the same way as for area, by defining the volume  $V$  of a rectangular polyhedron with sides  $a$ ,  $b$ ,  $c$  as  $V = abc$ . But then we encounter a first problem: a general polyhedron cannot be cut into a cube by straight cuts! The limitation was discovered in 1900 and 1902 by Max Dehn.\* He found that the possibility depends on the values of the edge angles, or dihedral angles, as the mathematicians call them. If one ascribes to every edge of a general polyhedron a number given by its length  $l$  times a special function  $g(\alpha)$  of its dihedral angle  $\alpha$ , then Dehn found that the sum of all the numbers for all the edges of a solid does not change under dissection, provided that the function fulfils  $g(\alpha + \beta) = g(\alpha) + g(\beta)$  and  $g(\pi) = 0$ . An example of such a strange function  $g$  is the one assigning the value 0 to any rational multiple of  $\pi$  and the value 1 to a basis set of irrational multiples of  $\pi$ . The values for all other dihedral angles of the polyhedron can then be constructed by combination of rational multiples of these basis angles. Using this function, you may then deduce for yourself that a cube cannot be dissected into a regular tetrahedron because their respective Dehn invariants are different.\*\*

Challenge 51 s

Despite the problems with Dehn invariants, one *can* define a rigid and additive concept of volume for polyhedra, since for all polyhedra and, in general, for all ‘nicely curved’ shapes, one can again use integration for the definition of their volume.

Ref. 40

Now let us consider general shapes and general cuts in three dimensions, not just the ‘nice’ ones mentioned so far. We then stumble on the famous *Banach–Tarski theorem* (or paradox). In 1924, Stefan Banach and Alfred Tarski\*\*\* proved that it is possible to cut one sphere into five pieces that can be recombined to give two spheres, each the size of the original. This counter-intuitive result is the Banach–Tarski theorem. Even worse, another version of the theorem states: take any two sets not extending to infinity and containing a solid sphere each; then it is always possible to dissect one into the other with a *finite*

are complications that will not be discussed here. In addition, the problems mentioned in the definition of length of fractals also reappear for area if the surface to be measured is not flat. A typical example is the area of the human lung: depending on the level of details examined, one finds area values from a few up to over a hundred square metres.

\* Max Dehn (1878–1952), German mathematician, student of David Hilbert.

\*\* This is also told in the beautiful book by M. AIGLER & G. M. ZIEGLER, *Proofs from the Book*, Springer Verlag, 1999. The title is due to the famous habit of the great mathematician Paul Erdős to imagine that all beautiful mathematical proofs can be assembled in the ‘book of proofs’.

\*\*\* Alfred Tarski (b. 1902 Warsaw, d. 1983 Berkeley), Polish mathematician.







**FIGURE 27** Straight lines found in nature: cerussite (picture width approx. 3 mm, © Stephan Wolfsried) and selenite (picture width approx. 15 m, © Arch. Speleoresearch & Films/La Venta at [www.laventa.it](http://www.laventa.it) and [www.naica.com.mx](http://www.naica.com.mx)).

number of cuts. In particular it is possible to dissect a pea into the Earth, or vice versa. Size does not count!\* Volume is thus not a useful concept at all.

Challenge 52 s

The Banach–Tarski theorem raises two questions: first, can the result be applied to gold or bread? That would solve many problems. Second, can it be applied to empty space? In other words, are matter and empty space continuous? Both topics will be explored later in our walk; each issue will have its own, special consequences. For the moment, we eliminate this troubling issue by restricting our interest to smoothly curved shapes (and cutting knives). With this restriction, volumes of matter and of empty space do behave nicely: they are additive and rigid, and show no paradoxes.\*\* Indeed, the cuts required for the Banach–Tarski paradox are not smooth; it is not possible to perform them with an everyday knife, as they require (infinitely many) infinitely sharp bends performed with an infinitely sharp knife. Such a knife does not exist. Nevertheless, we keep in the back of our mind that the size of an object or of a piece of empty space is a tricky quantity – and that we need to be careful whenever we talk about it.

### WHAT IS STRAIGHT?

Ref. 43

When you see a solid object with a straight edge, it is a 99%-safe bet that it is man-made. Of course, there are exceptions, as shown in Figure 27.\*\*\* The largest crystals ever found are 18 m in length. But in general, the contrast between the objects seen in a city – buildings, furniture, cars, electricity poles, boxes, books – and the objects seen in a forest – trees, plants, stones, clouds – is evident: in the forest nothing is straight or flat, in the city most objects are. How is it possible for humans to produce straight objects while there are almost none to be found in nature?

Vol. III, page 196

Ref. 41

\* The proof of the result does not need much mathematics; it is explained beautifully by Ian Stewart in Paradox of the spheres, *New Scientist*, 14 January 1995, pp. 28–31. The proof is based on the axiom of choice, which is presented later on. The Banach–Tarski paradox also exists in four dimensions, as it does in any higher dimension. More mathematical detail can be found in the beautiful book by Stan Wagon.

\*\* Mathematicians say that a so-called *Lebesgue measure* is sufficient in physics. This countably additive isometrically invariant measure provides the most general way to define a volume.

Page 328

Ref. 42

\*\*\* Another famous exception, unrelated to atomic structures, is the well-known Irish geological formation called the Giant’s Causeway. Other candidates that might come to mind, such as certain bacteria which have (almost) square or (almost) triangular shapes are not counter-examples, as the shapes are only approximate.





FIGURE 28 A photograph of the Earth – seen from the direction of the Sun (NASA).

Page 368

Any forest teaches us the origin of straightness; it presents tall tree trunks and rays of daylight entering from above through the leaves. For this reason we call a line *straight* if it touches either a plumb-line or a light ray along its whole length. In fact, the two definitions are equivalent. Can you confirm this? Can you find another definition? Obviously, we call a surface *flat* if for any chosen orientation and position the surface touches a plumb-line or a light ray along its whole extension.

Challenge 53 s

In summary, the concept of straightness – and thus also of flatness – is defined with the help of bodies or radiation. In fact, all spatial concepts, like all temporal concepts, require motion for their definition.

### A HOLLOW EARTH?

Space and straightness pose subtle challenges. Some strange people maintain that all humans live on the *inside* of a sphere; they (usually) call this the *hollow Earth theory*. They claim that the Moon, the Sun and the stars are all near the centre of the hollow sphere. They also explain that light follows curved paths in the sky and that when conventional physicists talk about a distance  $r$  from the centre of the Earth, the real hollow Earth distance is  $r_{\text{he}} = R_{\text{Earth}}^2/r$ . Can you show that this model is wrong? Roman Sexl\* used to ask this question to his students and fellow physicists. The answer is simple: if you think you have an argument to show that this view is wrong, you are mistaken! There is *no way* of

Ref. 44

Challenge 54 s

\* Roman Sexl, (1939–1986), important Austrian physicist, author of several influential textbooks on gravitation and relativity.







FIGURE 29 A model illustrating the hollow Earth theory, showing how day and night appear (© Helmut Diehl).

Challenge 55 e

Vol. II, page 259

showing that such a view is wrong. It is possible to explain the horizon, the appearance of day and night, as well as the satellite photographs of the round Earth, such as Figure 28. To explain what happened during a flight to the Moon is also fun. A coherent hollow Earth view is fully *equivalent* to the usual picture of an infinitely extended space. We will come back to this problem in the section on general relativity.

#### CURIOSITIES AND FUN CHALLENGES ABOUT EVERYDAY SPACE AND TIME

Challenge 56 s

How does one measure the speed of a gun bullet with a stop watch, in a space of  $1 \text{ m}^3$ , without electronics? Hint: the same method can also be used to measure the speed of light.

\* \*

Challenge 57 s

What is faster: an arrow or a motorbike?

\* \*

Challenge 58 s

A man wants to know how many stairs he would have to climb if the escalator in front of him, which is running upwards, were standing still. He walks up the escalator and counts 60 stairs; walking down the same escalator with the same speed he counts 90 stairs. What is the answer?

\* \*





FIGURE 30 When is a conical glass half full?

Challenge 59 e You have two hourglasses: one needs 4 minutes and one needs 3 minutes. How can you use them to determine when 5 minutes are over?

\* \*

Challenge 60 e You have two water containers: one of 3 litres, another of 5 litres. How can you use them to bring 4 litres of water?

\* \*

Challenge 61 s How can you make a hole in a postcard that allows you to step through it?

\* \*

Challenge 62 s What fraction of the height of a conical glass, shown in Figure 30, must be filled to make the glass half full?

\* \*

Challenge 63 s How many pencils are needed to draw a line as long as the equator of the Earth?

\* \*

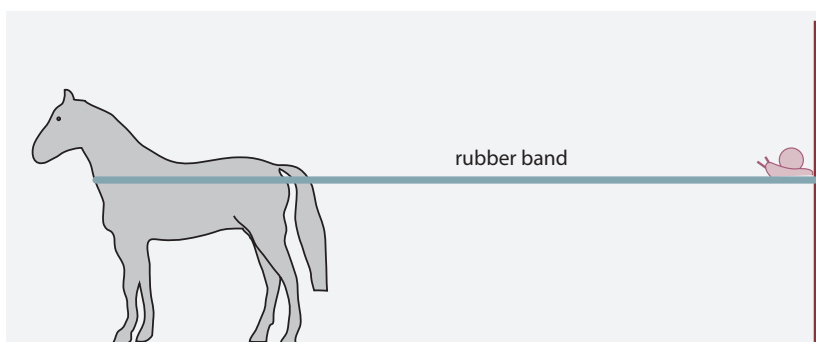
Challenge 64 s Everybody knows the puzzle about the bear: A hunter leaves his home, walks 10 km to the South and 10 km to the West, shoots a bear, walks 10 km to the North, and is back home. What colour is the bear? You probably know the answer straight away. Now comes the harder question, useful for winning money in bets. The house could be on several *additional* spots on the Earth; where are these less obvious spots from which a man can have *exactly* the same trip (forget the bear now) that was just described and be at home again?

\* \*

Challenge 65 s Imagine a rubber band that is attached to a wall on one end and is attached to a horse at the other end, as shown in Figure 31. On the rubber band, near the wall, there is a snail. Both the snail and the horse start moving, with typical speeds – with the rubber being infinitely stretchable. Can the snail reach the horse?

\* \*





**FIGURE 31** Can the snail reach the horse once it starts galloping away?

For a mathematician, 1 km is the same as 1000 m. For a physicist the two are different! Indeed, for a physicist, 1 km is a measurement lying between 0.5 km and 1.5 km, whereas 1000 m is a measurement between 999.5 m and 1000.5 m. So be careful when you write down measurement values. The professional way is to write, for example, 1000(8) m to mean  $1000 \pm 8$  m, i.e., a value between 992 and 1008 m.

\* \*

**Challenge 66 s** Imagine a black spot on a white surface. What is the colour of the line separating the spot from the background? This question is often called Peirce's puzzle.

\* \*

**Challenge 67 s** Also bread is an (approximate) fractal, though an irregular one. The fractal dimension of bread is around 2.7. Try to measure it!

\* \*

**Challenge 68 e** How do you find the centre of a beer mat using paper and pencil?

\* \*

**Challenge 69 s** How often in 24 hours do the hour and minute hands of a clock lie on top of each other? For clocks that also have a second hand, how often do all three hands lie on top of each other?

\* \*

**Challenge 70 s** How many times in twelve hours can the two hands of a clock be *exchanged* with the result that the new situation shows a *valid* time? What happens for clocks that also have a third hand for seconds?

\* \*

**Challenge 71 s** How many minutes does the Earth rotate in one minute?

\* \*

**Challenge 72 s** What is the highest speed achieved by throwing (with and without a racket)? What was the projectile used?



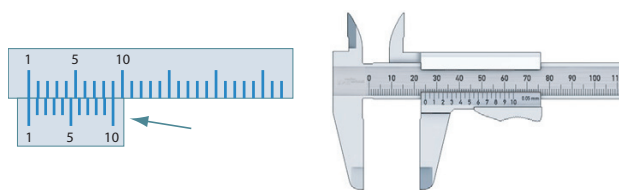


FIGURE 32 A 9-to-10 vernier/nonius/clavius and a 19-to-20 version (in fact, a 38-to-40 version) in a caliper (© [www.medien-werkstatt.de](http://www.medien-werkstatt.de)).

\* \*

- Challenge 73 s A rope is put around the Earth, on the Equator, as tightly as possible. The rope is then lengthened by 1 m. Can a mouse slip under the rope? The original, tight rope is lengthened by 1 mm. Can a child slip under the rope?

\* \*

- Challenge 74 s Jack was rowing his boat on a river. When he was under a bridge, he dropped a ball into the river. Jack continued to row in the same direction for 10 minutes after he dropped the ball. He then turned around and rowed back. When he reached the ball, the ball had floated 600 m from the bridge. How fast was the river flowing?

\* \*

- Challenge 75 e Adam and Bert are brothers. Adam is 18 years old. Bert is twice as old as at the time when Adam was the age that Bert is now. How old is Bert?

\* \*

- Challenge 76 s ‘Where am I?’ is a common question; ‘When am I?’ is never asked, not even in other languages. Why?

\* \*

- Challenge 77 s Is there a smallest time interval in nature? A smallest distance?

\* \*

- Challenge 78 s Given that you know what straightness is, how would you characterize or define the curvature of a curved line using numbers? And that of a surface?

\* \*

- Challenge 79 s What is the speed of your eyelid?

\* \*

- Challenge 80 s The surface area of the human body is about  $400 \text{ m}^2$ . Can you say where this large number comes from?

\* \*

How does a *vernier* work? It is called *nonius* in other languages. The first name is derived from a French military engineer\* who did not invent it, the second is a play of words

\* Pierre Vernier (1580–1637), French military officer interested in cartography.



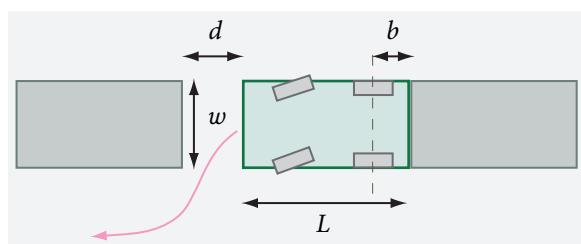


FIGURE 33 Leaving a parking space.

on the Latinized name of the Portuguese inventor of a more elaborate device\* and the Latin word for 'nine'. In fact, the device as we know it today – shown in Figure 32 – was designed around 1600 by Christophonius Clavius,\*\* the same astronomer whose studies were the basis of the Gregorian calendar reform of 1582. Are you able to design a vernier/nonius/clavius that, instead of increasing the precision tenfold, does so by an arbitrary factor? Is there a limit to the attainable precision?

Challenge 81 s

\* \*

Page 52 Fractals in three dimensions bear many surprises. Let us generalize Figure 25 to three dimensions. Take a regular tetrahedron; then glue on every one of its triangular faces a smaller regular tetrahedron, so that the surface of the body is again made up of many equal regular triangles. Repeat the process, gluing still smaller tetrahedrons to these new (more numerous) triangular surfaces. What is the shape of the final fractal, after an infinite number of steps?

Challenge 82 s

\* \*

Motoring poses many mathematical problems. A central one is the following parking issue: what is the shortest distance  $d$  from the car in front necessary to leave a parking spot without using reverse gear? (Assume that you know the geometry of your car, as shown in Figure 33, and its smallest outer turning radius  $R$ , which is known for every car.) Next question: what is the smallest gap required when you are allowed to manoeuvre back and forward as often as you like? Now a problem to which no solution seems to be available in the literature: How does the gap depend on the number,  $n$ , of times you use reverse gear? (The author had offered 50 euro for the first well-explained solution; the solution by Daniel Hawkins is now found in the appendix.)

Challenge 83 s

Challenge 84 s

Challenge 85 s

\* \*

Scientists use a special way to write large and small numbers, explained in Table 12.

\* \*

Ref. 45 In 1996 the smallest experimentally probed distance was  $10^{-19}$  m, achieved between quarks at Fermilab. (To savour the distance value, write it down without the exponent.)

Challenge 86 s

\* Pedro Nuñez or Peter Nonnius (1502–1578), Portuguese mathematician and cartographer.

\*\* Christophonius Clavius or Schlüssel (1537–1612), Bavarian astronomer, one of the main astronomers of his time.



TABLE 12 The exponential notation: how to write small and large numbers.

NUMBER	EXPONENTIAL NOTATION	NUMBER	EXPONENTIAL NOTATION
1	$10^0$	10	$10^1$
0.1	$10^{-1}$	20	$2 \cdot 10^1$
0.2	$2 \cdot 10^{-1}$	32.4	$3.24 \cdot 10^1$
0.0324	$3.24 \cdot 10^{-2}$	100	$10^2$
0.01	$10^{-2}$	1000	$10^3$
0.001	$10^{-3}$	10 000	$10^4$
0.0001	$10^{-4}$	56 000	$5.6 \cdot 10^4$
0.000 056	$5.6 \cdot 10^{-5}$	100 000	$10^5$ etc.
0.000 01	$10^{-5}$ etc.		

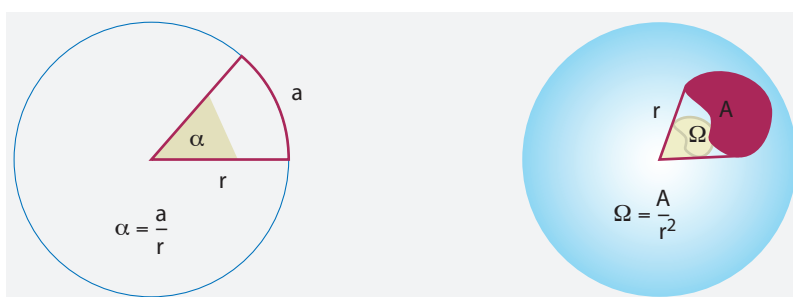


FIGURE 34 The definition of plane and solid angles.

\* \*

Zeno, the Greek philosopher, discussed in detail what happens to a moving object at a given instant of time. To discuss with him, you decide to build the fastest possible shutter for a photographic camera that you can imagine. You have all the money you want. What is the shortest shutter time you would achieve?

Challenge 87 s

\* \*

Can you prove Pythagoras' theorem by geometrical means alone, without using coordinates? (There are more than 30 possibilities.)

Challenge 88 s

\* \*

Page 55 Why are most planets and moons, including ours, (almost) spherical (see, for example, Challenge 89 s Figure 28)?

\* \*

Challenge 90 s A rubber band connects the tips of the two hands of a clock. What is the path followed by the mid-point of the band?

\* \*



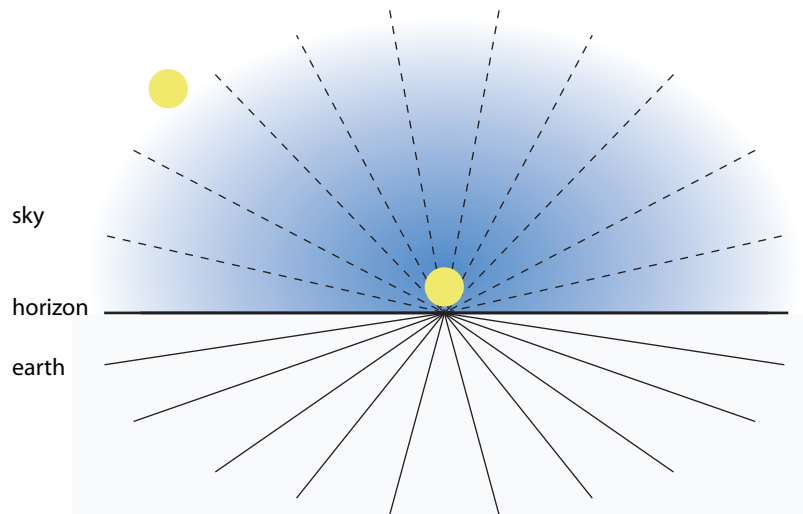


FIGURE 35 How the apparent size of the Moon and the Sun changes during a day.

There are two important quantities connected to angles. As shown in Figure 34, what is usually called a (*plane*) *angle* is defined as the ratio between the lengths of the arc and the radius. A right angle is  $\pi/2$  *radian* (or  $\pi/2$  rad) or  $90^\circ$ .

The *solid angle* is the ratio between area and the square of the radius. An eighth of a sphere is  $\pi/2$  *steradian* or  $\pi/2$  sr. (Mathematicians, of course, would simply leave out the steradian unit.) As a result, a small solid angle shaped like a cone and the angle of the cone tip are *different*. Can you find the relationship?

Challenge 91 s

\* \*

The definition of angle helps to determine the size of a firework display. Measure the time  $T$ , in seconds, between the moment that you see the rocket explode in the sky and the moment you hear the explosion, measure the (*plane*) angle  $\alpha$  – pronounced ‘alpha’ – of the ball formed by the firework with your hand. The diameter  $D$  is

$$D \approx \frac{6 \text{ m}}{s^\circ} T \alpha . \quad (3)$$

Challenge 92 e

Why? For more about fireworks, see the [cc oulu.fi/~kempmp](http://cc oulu.fi/~kempmp) website. By the way, the angular distance between the knuckles of an extended fist are about  $3^\circ$ ,  $2^\circ$  and  $3^\circ$ , the size of an extended hand  $20^\circ$ . Can you determine the other angles related to your hand?

Challenge 93 s

\* \*

Using angles, the *sine*, *cosine*, *tangent*, *cotangent*, *secant* and *cosecant* can be defined, as shown in Figure 36. You should remember this from secondary school. Can you confirm

Challenge 94 e

that  $\sin 15^\circ = (\sqrt{6} - \sqrt{2})/4$ ,  $\sin 18^\circ = (-1 + \sqrt{5})/4$ ,  $\sin 36^\circ = \sqrt{10 - 2\sqrt{5}}/4$ ,  $\sin 54^\circ =$





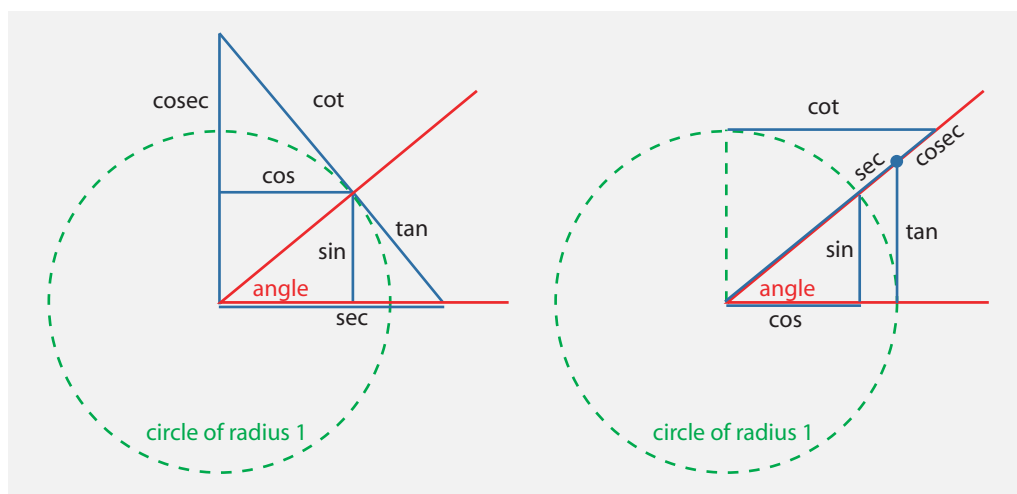


FIGURE 36 Two equivalent definitions of the sine, cosine, tangent, cotangent, secant and cosecant of an angle.

$(1 + \sqrt{5})/4$  and that  $\sin 72^\circ = \sqrt{10 + 2\sqrt{5}}/4$ ? Can you show also that

$$\frac{\sin x}{x} = \cos \frac{x}{2} \cos \frac{x}{4} \cos \frac{x}{8} \dots \quad (4)$$

Challenge 95 e is correct?

\* \*

Measuring angular size with the eye only is tricky. For example, can you say whether the Moon is larger or smaller than the nail of your thumb at the end of your extended arm?

Challenge 96 e Angular size is not an intuitive quantity; it requires measurement instruments.

A famous example, shown in Figure 35, illustrates the difficulty of estimating angles. Both the Sun and the Moon seem larger when they are on the horizon. In ancient times, Ptolemy explained this so-called *Moon illusion* by an unconscious apparent distance change induced by the human brain. Indeed, the Moon illusion disappears when you look at the Moon through your legs. In fact, the Moon is even *further away* from the observer when it is just above the horizon, and thus its image is *smaller* than it was a few hours earlier, when it was high in the sky. Can you confirm this?

Challenge 97 s

The Moon's angular size changes even more due to another effect: the orbit of the Moon round the Earth is elliptical. An example of the consequence is shown in Figure 37.

\* \*

Galileo also made mistakes. In his famous book, the *Dialogues*, he says that the curve formed by a thin chain hanging between two nails is a parabola, i.e., the curve defined by  $y = x^2$ . That is not correct. What is the correct curve? You can observe the shape (approximately) in the shape of suspension bridges.

Challenge 98 d



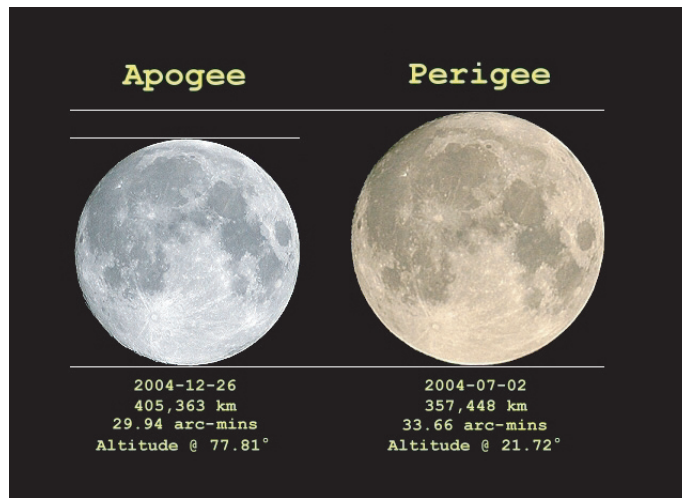


FIGURE 37 How the size of the Moon actually changes during its orbit (© Anthony Ayiomamitis).

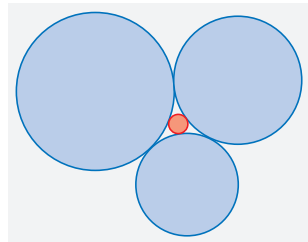


FIGURE 38 A famous puzzle: how are the four radii related?

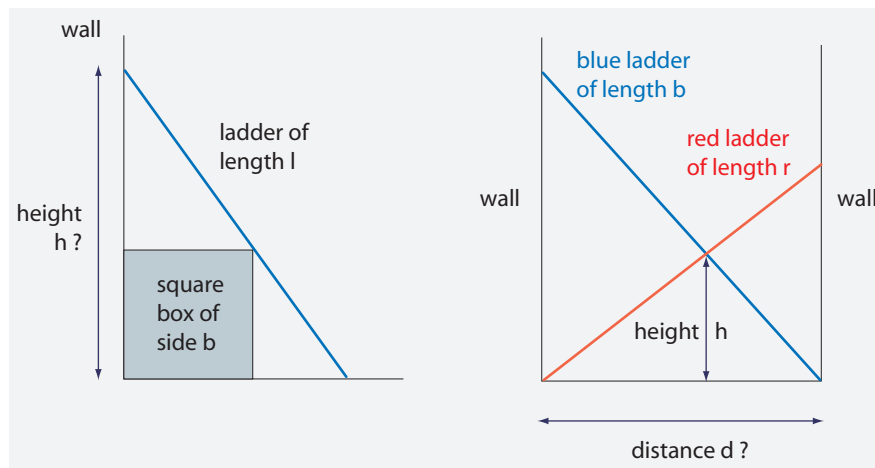


FIGURE 39 Two ladder puzzles: a moderately difficult (left) and a difficult one (right).

\* \*

Draw three circles, of different sizes, that touch each other, as shown in Figure 38. Now draw a fourth circle in the space between, touching the outer three. What simple relation do the inverse radii of the four circles obey?

Challenge 99 s



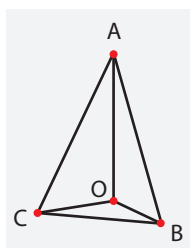


FIGURE 40 What is the area ABC, given the other three areas and three right angles at O?



FIGURE 41 Anticrepuscular rays - where is the Sun in this situation? (© Peggy Peterson)

\* \*

- Ref. 46 There are many puzzles about ladders. Two are illustrated in Figure 39. If a 5 m ladder is put against a wall in such a way that it just touches a box with 1 m height and depth,
- Challenge 100 s how high does the ladder reach? If two ladders are put against two facing walls, and if the lengths of the ladders and the height of the crossing point are known, how distant
- Challenge 101 d are the walls?

\* \*

- Challenge 102 s With two rulers, you can add and subtract numbers by lying them side by side. Are you able to design rulers that allow you to multiply and divide in the same manner?

\* \*

- Challenge 103 s How many days would a year have if the Earth turned the other way with the same rotation frequency?

\* \*

- Challenge 104 s Take a tetrahedron OABC whose triangular sides OAB, OBC and OAC are rectangular in O. In other words, the edges OA, OB and OC are all perpendicular to each other. In the tetrahedron, the areas of the triangles OAB, OBC and OAC are respectively 8, 4 and 1. What is the area of triangle ABC?

\* \*

- Challenge 105 s The Sun is hidden in the spectacular situation shown in Figure 41 Where is it?





**FIGURE 42** An open research problem: What is the ropelength of a tight knot? (© Piotr Pieranski, from Ref. 48)

\* \*

A slightly different, but equally fascinating situation – and useful for getting used to perspective drawing – appears when you have a lighthouse in your back. Can you draw the rays you see in the sky up to the horizon?

Challenge 106 e

\* \*

Two cylinders of equal radius intersect at a right angle. What is the value of the intersection volume? (First make a drawing.)

Challenge 107 s

\* \*

Two sides of a hollow cube with side length 1 dm are removed, to yield a tunnel with square opening. Is it true that a cube with edge length 1.06 dm can be made to pass through the hollow cube with side length 1 dm?

Challenge 108 s

\* \*

Ref. 47 Could a two-dimensional universe exist? Alexander Dewdney imagined such a universe in great detail and wrote a well-known book about it. He describes houses, the transportation system, digestion, reproduction and much more. Can you explain why a two-dimensional universe is impossible?

Challenge 109 d

\* \*

Some researchers are investigating whether time could be two-dimensional. Can this be?

Challenge 110 s

\* \*

Other researchers are investigating whether space could have more than three dimensions. Can this be?

Challenge 111 s

\* \*

Here is a simple challenge on length that nobody has solved yet. Take a piece of ideal rope: of constant radius, ideally flexible, and completely slippery. Tie a tight knot into it, as shown in Figure 42. By how much did the two ends of the rope come closer together?

Challenge 112 r

### SUMMARY ABOUT EVERYDAY SPACE AND TIME

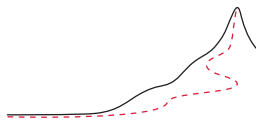
Motion defines speed, time and length. Observations of everyday life and precision experiments are conveniently and precisely described by modelling velocity as a Euclidean



vector, space as a three-dimensional Euclidean space, and time as a one-dimensional real line. These three definitions form the everyday, or *Galilean*, description of our environment.

Modelling velocity, time and space as *continuous* quantities is precise and convenient. However, this common model cannot be confirmed by experiment. For example, no experiments can check distances larger than  $10^{25}$  m or smaller than  $10^{-25}$  m; the continuous model is likely to be incorrect there. We will find out later on that this is indeed the case.





## CHAPTER 3

# HOW TO DESCRIBE MOTION – KINEMATICS

“La filosofia è scritta in questo grandissimo libro che continuamente ci sta aperto innanzi agli occhi (io dico l’universo) ... Egli è scritto in lingua matematica.\*”  
Galileo Galilei, *Il saggiatore* VI.

Experiments show that the properties of Galilean time and space are extracted from the environment by most higher animals and by young children. Among others, this has been tested for cats, dogs, rats, mice, ants, fish and many other species. They all find the same results.

First of all, *motion is change of position with time*. This description is illustrated by rapidly flipping the lower left corners of this book, starting at [page 195](#). Each page simulates an instant of time, and the only change that takes place during motion is in the position of the object, represented by the dark spot. The other variations from one picture to the next, which are due to the imperfections of printing techniques, can be taken to simulate the inevitable measurement errors.

Calling ‘motion’ the change of position with time is *neither* an explanation *nor* a definition, since both the concepts of time and position are deduced from motion itself. It is only a *description* of motion. Still, the description is useful, because it allows for high precision, as we will find out by exploring gravitation and electrodynamics. After all, precision is our guiding principle during this promenade. Therefore the detailed description of changes in position has a special name: it is called *kinematics*.

The idea of change of positions implies that the object can be *followed* during its motion. This is not obvious; in the section on quantum theory we will find examples where this is impossible. But in everyday life, objects can always be tracked. The set of all positions taken by an object over time forms its *path* or *trajectory*. The origin of this concept is evident when one watches fireworks or again the flip film in the lower left corners starting at [page 195](#).

In everyday life, animals and humans agree on the Euclidean properties of velocity, space and time. In particular, this implies that a trajectory can be described by specifying three numbers, three *coordinates* ( $x, y, z$ ) – one for each dimension – as continuous functions of time  $t$ . (Functions are defined in detail on [page 199](#).) This is usually written as  $\mathbf{x} = \mathbf{x}(t) = (x(t), y(t), z(t))$ . For example, already Galileo found, using stopwatch and

\* Science is written in this huge book that is continuously open before our eyes (I mean the universe) ... It is written in mathematical language.



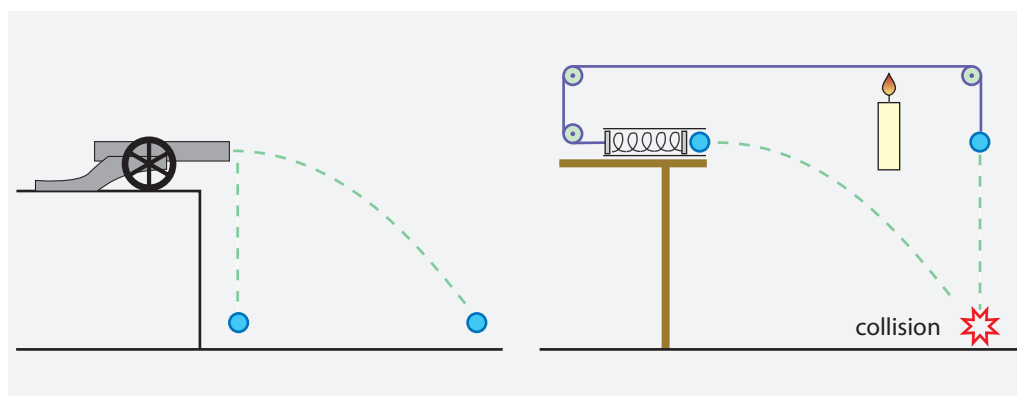


FIGURE 43 Two ways to test that the time of free fall does not depend on horizontal velocity.

ruler, that the height  $z$  of any thrown or falling stone changes as

$$z(t) = z_0 + v_0(t - t_0) - \frac{1}{2}g(t - t_0)^2 \quad (5)$$

where  $t_0$  is the time the fall starts,  $z_0$  is the initial height,  $v_0$  is the initial velocity in the vertical direction and  $g = 9.8 \text{ m/s}^2$  is a constant that is found to be the same, within about one part in 300, for all falling bodies on all points of the surface of the Earth. Where do the value  $9.8 \text{ m/s}^2$  and its slight variations come from? A preliminary answer will be given shortly, but the complete elucidation will occupy us during the larger part of this hike.

Ref. 50

The special case with no initial velocity is of great interest. Like a few people before him, Galileo made it clear that  $g$  is the same for all bodies, if air resistance can be neglected. He had many arguments for this conclusion; Can you find one? And of course, his famous experiment at the leaning tower in Pisa confirmed the statement. (It is a *false* urban legend that Galileo never performed the experiment.)

Page 165

Ref. 51

Equation (5) therefore allows us to determine the depth of a well, given the time a stone takes to reach its bottom. The equation also gives the speed  $v$  with which one hits the ground after jumping from a tree, namely  $v = \sqrt{2gh}$ . A height of 3 m yields a velocity of 27 km/h. The velocity is thus proportional only to the square root of the height. Does this mean that one's strong fear of falling results from an overestimation of its actual effects?

Challenge 113 s

Challenge 114 s

Galileo was the first to state an important result about free fall: the motions in the horizontal and vertical directions are *independent*. He showed that the time it takes for a cannon ball that is shot exactly horizontally to fall is *independent* of the strength of the gunpowder, as shown in Figure 43. Many great thinkers did not agree with this statement even after his death: in 1658 the Academia del Cimento even organized an experiment to check this assertion, by comparing the flying cannon ball with one that simply fell vertically. Can you imagine how they checked the simultaneity? Figure 43 also shows how you can check this at home. In this experiment, whatever the spring load of the cannon, the two bodies will always collide in mid-air (if the table is high enough), thus proving the assertion.

Ref. 52

Challenge 115 s





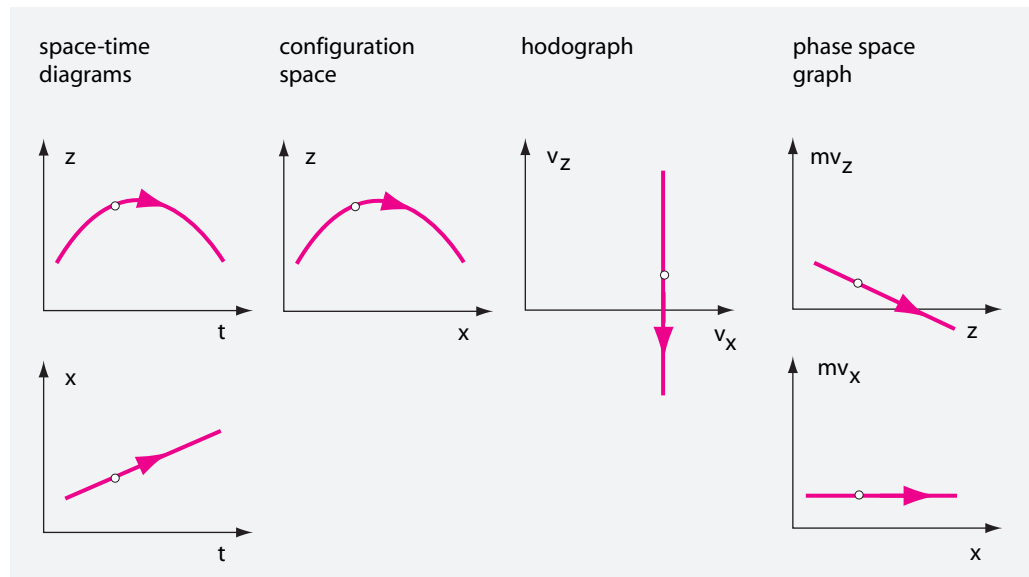


FIGURE 44 Various types of graphs describing the same path of a thrown stone.

In other words, a flying canon ball is not accelerated in the horizontal direction. Its horizontal motion is simply unchanging. By extending the description of equation (5) with the two expressions for the horizontal coordinates  $x$  and  $y$ , namely

$$\begin{aligned} x(t) &= x_0 + v_{x0}(t - t_0) \\ y(t) &= y_0 + v_{y0}(t - t_0), \end{aligned} \quad (6)$$

a *complete* description for the path followed by thrown stones results. A path of this shape is called a *parabola*; it is shown in Figures 18, 43 and 44. (A parabolic shape is also used for light reflectors inside pocket lamps or car headlights. Can you show why?)

Physicists enjoy generalizing the idea of a path. As Figure 44 shows, a path is a trace left in a diagram by a moving object. Depending on what diagram is used, these paths have different names. Hodographs are used in weather forecasting. Space-time diagrams are useful to make the theory of relativity accessible. The *configuration space* is spanned by the coordinates of all particles of a system. For many particles, it has a high number of dimensions. It plays an important role in self-organization. The difference between chaos and order can be described as a difference in the properties of paths in configuration space. The phase space diagram is also called *state space diagram*. It plays an essential role in thermodynamics.

### THROWING, JUMPING AND SHOOTING

The kinematic description of motion is useful for answering a whole range of questions.

\* \*

What is the upper limit for the long jump? The running peak speed world record in

Page 38  
Challenge 116 s  
Ref. 53



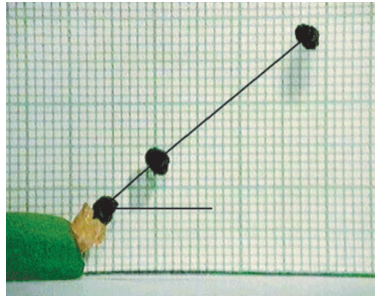


FIGURE 45 Three superimposed images of a frass pellet shot away by a caterpillar inside a rolled-up leaf (© Stanley Caveney).

- Ref. 54 2008 was over  $12.5 \text{ m/s} \approx 45 \text{ km/h}$  by Usain Bolt, and the 1997 women's record was
- Ref. 55  $11 \text{ m/s} \approx 40 \text{ km/h}$ . However, long jumpers never run much faster than about  $9.5 \text{ m/s}$ . How much extra jump distance could they achieve if they could run full speed? How could they achieve that? In addition, long jumpers take off at angles of about  $20^\circ$ , as they are not able to achieve a higher angle at the speed they are running. How much would they gain if they could achieve  $45^\circ$ ? (Is  $45^\circ$  the optimal angle?)
- Challenge 117 s

\* \*

What do the athletes Usain Bolt and Michael Johnson, the last two world record holders on the 200 m race at time of this writing, have in common? They were tall, athletic, and had many fast twitch fibres in the muscles. These properties made them good sprinters. A last difference made them world class sprinters: they had a flattened spine, with almost no S-shape. This abnormal condition saves them a little bit of time at every step, because the spine is not as flexible as in usual people, and allows them to excel at short distance races.

\* \*

Athletes continuously improve speed records. Racing horses do not. Why? For racing horses, breathing rhythm is related to gait; for human, it is not. As a result, racing horses cannot change or improve their technique, and the speed of racing horses is essentially the same since it is measured.

\* \*

- Challenge 118 s How can the speed of falling rain be measured using an umbrella? The answer is important: the same method can also be used to measure the speed of light, as we will find out later. (Can you guess how?)
- Vol. II, page 16

\* \*

- Challenge 119 ny When a dancer jumps in the air, how many times can he or she rotate around its vertical axis before arriving back on earth?

\* \*

- Ref. 57 Numerous species of moth and butterfly caterpillars shoot away their frass – to put it more crudely: their shit – so that its smell does not help predators to locate them. Stanley



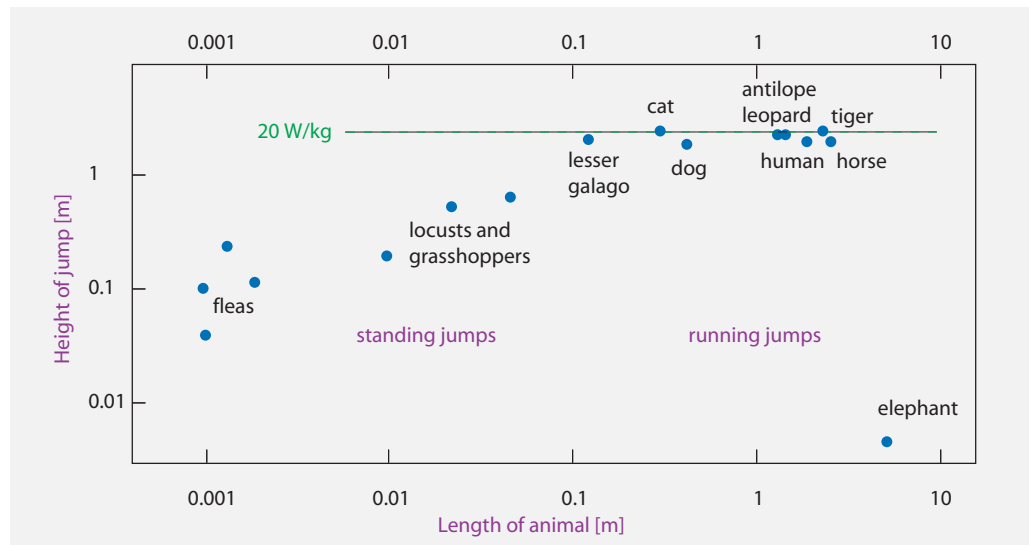


FIGURE 46 The height achieved by jumping land animals.

Caveney and his team took photographs of this process. Figure 45 shows a caterpillar (yellow) of the skipper *Calpodus ethlius* inside a rolled up green leaf caught in the act. Given that the record distance observed is 1.5 m (though by another species, *Epargyreus clarus*), what is the ejection speed? How do caterpillars achieve it?

Challenge 120 s

\* \*

What is the horizontal distance one can reach by throwing a stone, given the speed and the angle from the horizontal at which it is thrown?

Challenge 121 s

\* \*

Challenge 122 s What is the maximum numbers of balls that could be juggled at the same time? At the moment, robots can juggle three balls, as shown by the Sarcoman robot on [www.physio.northwestern.edu/Secondlevel/Miller/FirstLevel/histresearch.html](http://www.physio.northwestern.edu/Secondlevel/Miller/FirstLevel/histresearch.html). It is a challenge for robotics to reach the maximum number of balls in the future.

\* \*

Is it true that rain drops would kill if it weren't for the air resistance of the atmosphere? What about hail?

Challenge 123 s

\* \*

Challenge 124 s Are bullets, fired into the air from a gun, dangerous when they fall back down?

\* \*

Challenge 125 s Police finds a dead human body at the bottom of cliff with a height of 30 m, at a distance of 12 m from the cliff. Was it suicide or murder?

\* \*



Ref. 58 All land animals, regardless of their size, achieve jumping heights of at most 2 m, as shown in Figure 46. The explanation of this fact takes only two lines. Can you find it?

Challenge 126 s

The last two issues arise because equation (5) does not hold in all cases. For example, leaves or potato crisps do not follow it. As Galileo already knew, this is a consequence of air resistance; we will discuss it shortly. Because of air resistance, the path of a stone is not always a parabola.

In fact, there are other situations where the path of a falling stone is not a parabola. Can you find one?

Challenge 127 s

### ENJOYING VECTORS

Physical quantities with a defined direction, such as speed, are described with three numbers, or three components, and are called *vectors*. Learning to calculate with such multi-component quantities is an important ability for many sciences. Here is a summary.

Vectors can be pictured by small arrows. Note that vectors do not have specified points at which they start: two arrows with same direction and the same length are the *same* vector, even if they start at different points in space. Since vectors behave like arrows, they can be added and they can be multiplied by numbers. For example, stretching an arrow  $\mathbf{a} = (a_x, a_y, a_z)$  by a number  $c$  corresponds, in component notation, to the vector  $c\mathbf{a} = (ca_x, ca_y, ca_z)$ .

In precise, mathematical language, a vector is an element of a set, called *vector space*, in which the following properties hold for all vectors  $\mathbf{a}$  and  $\mathbf{b}$  and for all numbers  $c$  and  $d$ :

$$c(\mathbf{a} + \mathbf{b}) = c\mathbf{a} + c\mathbf{b} \quad , \quad (c + d)\mathbf{a} = c\mathbf{a} + d\mathbf{a} \quad , \quad (cd)\mathbf{a} = c(d\mathbf{a}) \quad \text{and} \quad 1\mathbf{a} = \mathbf{a} . \quad (7)$$

Examples of vector spaces are the set of all *positions* of an object, or the set of all its possible velocities. Does the set of all rotations form a vector space?

Challenge 128 s

All vector spaces allow the definition of a unique *null vector* and of one *negative vector* for each vector.

Challenge 129 e

In most vector spaces of importance in science the concept of *length* (specifying the ‘magnitude’) can be introduced. This is done via an intermediate step, namely the introduction of the scalar product of two vectors. The product is called ‘scalar’ because its result is a scalar; a *scalar* is a number that is the same in for all observers; for example, it is the same for observers with different orientations. The *scalar product* between two vectors  $\mathbf{a}$  and  $\mathbf{b}$  is a number that satisfies

$$\begin{aligned} \mathbf{a}\mathbf{a} &\geq 0 \quad , \\ \mathbf{a}\mathbf{b} &= \mathbf{b}\mathbf{a} \quad , \\ (\mathbf{a} + \mathbf{a}')\mathbf{b} &= \mathbf{a}\mathbf{b} + \mathbf{a}'\mathbf{b} \quad , \\ \mathbf{a}(\mathbf{b} + \mathbf{b}') &= \mathbf{a}\mathbf{b} + \mathbf{a}\mathbf{b}' \quad \text{and} \\ (c\mathbf{a})\mathbf{b} &= \mathbf{a}(c\mathbf{b}) = c(\mathbf{a}\mathbf{b}) . \end{aligned} \quad (8)$$

This definition of a scalar product is not unique; however, there is a *standard* scalar prod-



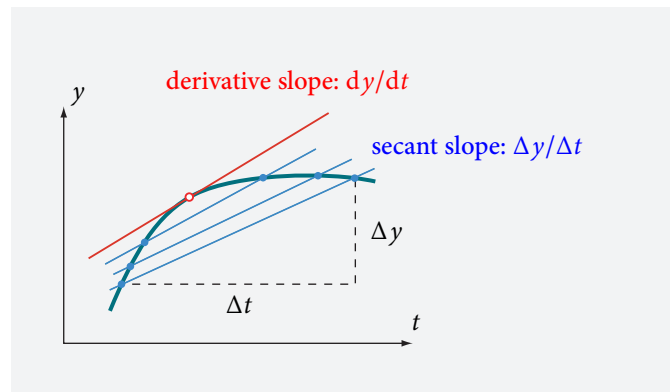


FIGURE 47 The derivative in a point as the limit of secants.

uct. In Cartesian coordinate notation, the standard scalar product is given by

$$\mathbf{ab} = a_x b_x + a_y b_y + a_z b_z . \quad (9)$$

Challenge 130 e

If the scalar product of two vectors vanishes the two vectors are *orthogonal*, at a right angle to each other. (Show it!)

The *length* or *norm* of a vector can then be defined as the square root of the scalar product of a vector with itself:  $a = \sqrt{\mathbf{aa}}$ . Often, and also in this text, lengths are written in italic letters, whereas vectors are written in bold letters. A vector space with a scalar product is called an *Euclidean* vector space.

Challenge 131 s

The scalar product is also useful for specifying directions. Indeed, the scalar product between two vectors encodes the angle between them. Can you deduce this important relation?

### WHAT IS REST? WHAT IS VELOCITY?

In the Galilean description of nature, motion and rest are opposites. In other words, a body is at rest when its position, i.e., its coordinates, do not change with time. In other words, (Galilean) *rest* is defined as

$$\mathbf{x}(t) = \text{const} . \quad (10)$$

We recall that  $\mathbf{x}(t)$  is the abbreviation for the three coordinates  $(x(t), y(t), z(t))$ . Later we will see that this definition of rest, contrary to first impressions, is not much use and will have to be expanded. Nevertheless, any definition of rest implies that non-resting objects can be distinguished by comparing the rapidity of their displacement. Thus we can define the *velocity*  $\mathbf{v}$  of an object as the change of its position  $\mathbf{x}$  with time  $t$ . This is usually written as

$$\mathbf{v} = \frac{d\mathbf{x}}{dt} . \quad (11)$$

In this expression, valid for each coordinate separately,  $d/dt$  means ‘change with time’. We can thus say that velocity is the *derivative* of position with respect to time. The *speed*





FIGURE 48 Gottfried Leibniz (1646–1716).

$v$  is the name given to the magnitude of the velocity  $\mathbf{v}$ . Derivatives are written as fractions in order to remind the reader that they are derived from the idea of slope. The expression

$$\frac{ds}{dt} \text{ is meant as an abbreviation of } \lim_{\Delta t \rightarrow 0} \frac{\Delta s}{\Delta t}, \quad (12)$$

a shorthand for saying that the *derivative at a point* is the limit of the secant slopes in the neighbourhood of the point, as shown in Figure 47. This definition implies the working rules

Challenge 132 e

$$\frac{d(s+r)}{dt} = \frac{ds}{dt} + \frac{dr}{dt}, \quad \frac{d(cs)}{dt} = c \frac{ds}{dt}, \quad \frac{d}{dt} \frac{ds}{dt} = \frac{d^2s}{dt^2}, \quad \frac{d(sr)}{dt} = \frac{ds}{dt}r + s \frac{dr}{dt}, \quad (13)$$

$c$  being any number. This is all one ever needs to know about derivatives. Quantities such as  $dt$  and  $ds$ , sometimes useful by themselves, are called *differentials*. These concepts are due to Gottfried Wilhelm Leibniz.\* Derivatives lie at the basis of all calculations based on the continuity of space and time. Leibniz was the person who made it possible to describe and use velocity in physical formulae and, in particular, to use the idea of velocity at a given point in time or space for calculations.

The definition of velocity assumes that it makes sense to take the limit  $\Delta t \rightarrow 0$ . In other words, it is assumed that infinitely small time intervals do exist in nature. The definition of velocity with derivatives is possible only because both space and time are described by sets which are *continuous*, or in mathematical language, *connected and complete*. In the rest of our walk we shall not forget that from the beginning of classical physics, *infinities* are present in its description of nature. The infinitely small is part of our definition of velocity. Indeed, differential calculus can be defined as the study of infinity and its uses. We thus discover that the appearance of infinity does not automatically render a description impossible or imprecise. In order to remain precise, physicists use only the smallest two of the various possible types of infinities. Their precise definition and an overview of other types are introduced in later on.

Vol. III, page 197

\* Gottfried Wilhelm Leibniz (b. 1646 Leipzig, d. 1716 Hannover), Saxon lawyer, physicist, mathematician, philosopher, diplomat and historian. He was one of the great minds of mankind; he invented the differential calculus (before Newton) and published many influential and successful books in the various fields he explored, among them *De arte combinatoria*, *Hypothesis physica nova*, *Discours de métaphysique*, *Nouveaux essais sur l'entendement humain*, the *Théodicée* and the *Monadologia*.



Ref. 59 The appearance of infinity in the usual description of motion was first criticized in his famous ironical arguments by Zeno of Elea (around 445 BCE), a disciple of Parmenides. In his so-called third argument, Zeno explains that since at every instant a given object occupies a part of space corresponding to its size, the notion of velocity at a given instant makes no sense; he provokingly concludes that therefore motion does not exist. Nowadays we would not call this an argument against the *existence* of motion, but against its usual *description*, in particular against the use of infinitely divisible space and time. (Do you agree?) Nevertheless, the description criticized by Zeno actually works quite well in everyday life. The reason is simple but deep: in daily life, changes are indeed continuous.

Challenge 133 e

Vol. VI, page 58

Large changes in nature are made up of many small changes. This property of nature is not obvious. For example, we note that we have tacitly assumed that the path of an object is not a fractal or some other badly behaved entity. In everyday life this is correct; in other domains of nature it is not. The doubts of Zeno will be partly rehabilitated later in our walk, and increasingly so the more we proceed. The rehabilitation is only partial, as the solution will be different from that which he envisaged; on the other hand, the doubts about the idea of ‘velocity at a point’ will turn out to be well-founded. For the moment though, we have no choice: we continue with the basic assumption that in nature changes happen smoothly.

Why is velocity necessary as a concept? Aiming for precision in the description of motion, we need to find the complete list of aspects necessary to specify the state of an object. The concept of velocity is obviously on this list.

### ACCELERATION

Continuing along the same line, we call *acceleration*  $\mathbf{a}$  of a body the change of velocity  $\mathbf{v}$  with time, or

$$\mathbf{a} = \frac{d\mathbf{v}}{dt} = \frac{d^2\mathbf{x}}{dt^2}. \quad (14)$$

Acceleration is what we feel when the Earth trembles, an aeroplane takes off, or a bicycle goes round a corner. More examples are given in Table 13. Like velocity, acceleration has both a magnitude and a direction, properties indicated by the use of **bold** letters for their abbreviations. In short, acceleration, like velocity, is a vector quantity.

Ref. 60 Acceleration is felt. The body is deformed and the sensors in our semicircular canals in the ear feel it. Higher accelerations can have stronger effects. For example, when accelerating a sitting person in the direction of the head at two or three times the value of usual gravitational acceleration, eyes stop working and the sight is greyed out, because the blood cannot reach the eye any more. Between 3 and 5g of continuous acceleration, or 7 to 9g of short time acceleration, consciousness is lost, because the brain does not receive enough blood, and blood may leak out of the feet or lower legs. High acceleration in the direction of the feet of a sitting person can lead to haemorrhagic strokes in the brain. The people most at risk are jet pilots; they have special clothes that send compressed air onto the pilot’s bodies to avoid blood accumulating in the wrong places.

Challenge 135 s

In a usual car, or on a motorbike, we can *feel* being accelerated. (These accelerations are below 1g and are therefore harmless.) Can you think of a situation where one is accelerated but does *not* feel it?





TABLE 13 Some measured acceleration values.

OBSERVATION	ACCELERATION
What is the lowest you can find?	Challenge 134 s
Back-acceleration of the galaxy M82 by its ejected jet	10 fm/s <sup>2</sup>
Acceleration of a young star by an ejected jet	10 pm/s <sup>2</sup>
Fathoumi Acceleration of the Sun in its orbit around the Milky Way	0.2 nm/s <sup>2</sup>
Deceleration of the Pioneer satellites, due to heat radiation imbalance	0.8 nm/s <sup>2</sup>
Centrifugal acceleration at Equator due to Earth's rotation	33 mm/s <sup>2</sup>
Electron acceleration in household electricity wire due to alternating current	50 mm/s <sup>2</sup>
Acceleration of fast underground train	1.3 m/s <sup>2</sup>
Gravitational acceleration on the Moon	1.6 m/s <sup>2</sup>
Minimum deceleration of a car, by law, on modern dry asphalt	5.5 m/s <sup>2</sup>
Gravitational acceleration on the Earth's surface, depending on location	9.8 ± 0.3 m/s <sup>2</sup>
Standard gravitational acceleration	9.806 65 m/s <sup>2</sup>
Highest acceleration for a car or motorbike with engine-driven wheels	15 m/s <sup>2</sup>
Space rockets at take-off	20 to 90 m/s <sup>2</sup>
Acceleration of cheetah	32 m/s <sup>2</sup>
Gravitational acceleration on Jupiter's surface	25 m/s <sup>2</sup>
Flying fly ( <i>Musca domestica</i> )	c. 100 m/s <sup>2</sup>
Acceleration of thrown stone	c. 120 m/s <sup>2</sup>
Acceleration that triggers air bags in cars	360 m/s <sup>2</sup>
Fastest leg-powered acceleration (by the froghopper, <i>Philaenus spumarius</i> , an insect)	4 km/s <sup>2</sup>
Tennis ball against wall	0.1 Mm/s <sup>2</sup>
Bullet acceleration in rifle	2 Mm/s <sup>2</sup>
Fastest centrifuges	0.1 Gm/s <sup>2</sup>
Acceleration of protons in large accelerator	90 Tm/s <sup>2</sup>
Acceleration of protons inside nucleus	10 <sup>31</sup> m/s <sup>2</sup>
Highest possible acceleration in nature	10 <sup>52</sup> m/s <sup>2</sup>

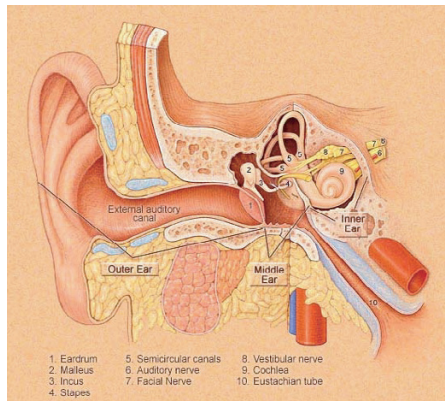
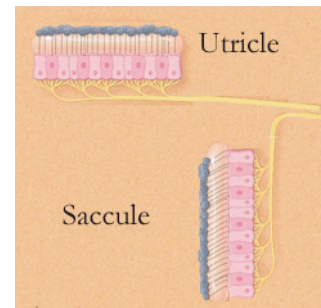
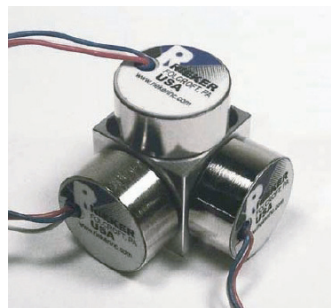
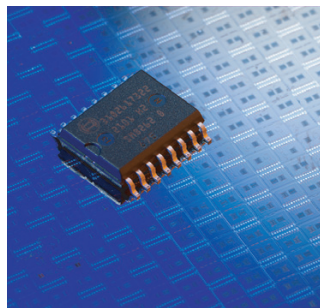
## Challenge 136 s

Higher derivatives than acceleration can also be defined in the same manner. They add little to the description of nature, because – as we will show shortly – neither these higher derivatives nor even acceleration itself are useful for the description of the state of motion of a system.



TABLE 14 Some acceleration sensors.

MEASUREMENT	SENSOR	RANGE
Direction of gravity in plants (roots, trunk, branches, leaves)	statoliths in cells	0 to 10 m/s <sup>2</sup>
Direction and value of accelerations in mammals	the membranes in each semicircular canal, and the utricle and saccule in the inner ear	0 to 20 m/s <sup>2</sup>
Direction and value of acceleration in modern step counters for hikers	piezoelectric sensors	0 to 20 m/s <sup>2</sup>
Direction and value of acceleration in car crashes	airbag sensor using piezoelectric ceramics	0 to 2000 m/s <sup>2</sup>



1. Eardrum
2. Malleus
3. Incus
4. Stapes
5. Semicircular canals
6. Auditory nerve
7. Facial Nerve
8. Vestibular nerve
9. Cochlea
10. Eustachian tube

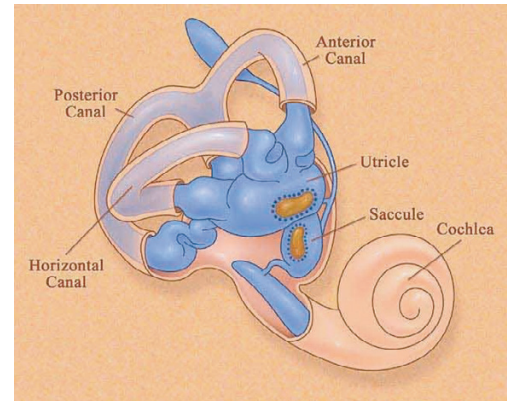


FIGURE 49 Three accelerometers: a one-axis piezoelectric airbag sensor, a three-axis capacitive accelerometer, and the utricle and saccule in the three semicircular canals inside the human ear (© Bosch, Rieker Electronics, Northwestern University).

### OBJECTS AND POINT PARTICLES

“Wenn ich den Gegenstand kenne, so kenne ich auch sämtliche Möglichkeiten seines Vorkommens in Sachverhalten.\*”

Ludwig Wittgenstein, *Tractatus*, 2.0123

\* ‘If I know an object, then I also know all the possibilities of its occurrence in atomic facts.’

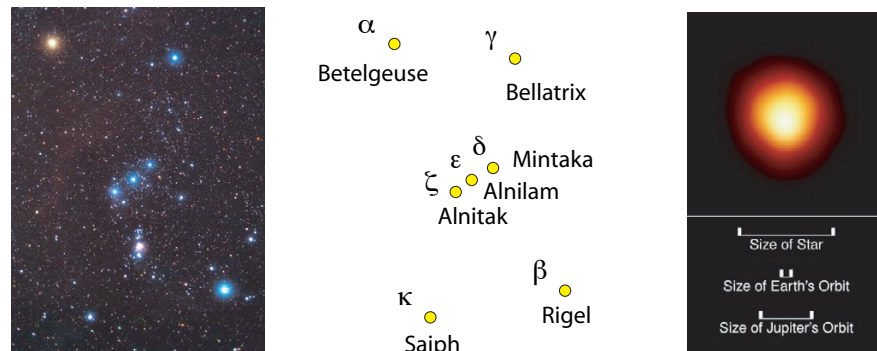


FIGURE 50 Orion in natural colours (© Matthew Spinelli) and Betelgeuse (ESA, NASA).

Challenge 137 e

One aim of the study of motion is to find a complete and precise description of both states and objects. With the help of the concept of space, the description of objects can be refined considerably. In particular, one knows from experience that all objects seen in daily life have an important property: they can be divided into *parts*. Often this observation is expressed by saying that all objects, or bodies, have two properties. First, they are made out of *matter*,\* defined as that aspect of an object responsible for its impenetrability, i.e., the property preventing two objects from being in the same place. Secondly, bodies have a certain form or *shape*, defined as the precise way in which this impenetrability is distributed in space.

In order to describe motion as accurately as possible, it is convenient to start with those bodies that are as simple as possible. In general, the smaller a body, the simpler it is. A body that is so small that its parts no longer need to be taken into account is called a *particle*. (The older term *corpuscle* has fallen out of fashion.) Particles are thus idealized small stones. The extreme case, a particle whose *size* is *negligible* compared with the dimensions of its motion, so that its position is described completely by a *single* triplet of coordinates, is called a *point particle* or a *point mass*. In equation (5), the stone was assumed to be such a point particle.

Do point-like objects, i.e., objects smaller than anything one can measure, exist in daily life? Yes and no. The most notable examples are the stars. At present, angular sizes as small as  $2 \mu\text{rad}$  can be measured, a limit given by the fluctuations of the air in the atmosphere. In space, such as for the Hubble telescope orbiting the Earth, the angular limit is due to the diameter of the telescope and is of the order of  $10 \text{ nrad}$ . Practically all stars seen from Earth are smaller than that, and are thus effectively ‘point-like’, even when seen with the most powerful telescopes.

As an exception to the general rule, the size of a few large and nearby stars, of red giant type, can be measured with special instruments.\*\* Betelgeuse, the higher of the two shoulders of Orion shown in Figure 50, Mira in Cetus, Antares in Scorpio, Aldebaran in

Ref. 61 \* Matter is a word derived from the Latin ‘*materia*’, which originally meant ‘wood’ and was derived via intermediate steps from ‘*mater*’, meaning ‘mother’.

\*\* The website [www.astro.uiuc.edu/~kaler/sow/sowlist.html](http://www.astro.uiuc.edu/~kaler/sow/sowlist.html) gives an introduction to the different types of stars. The [www.astro.wisc.edu/~dolan/constellations](http://www.astro.wisc.edu/~dolan/constellations) website provides detailed and interesting information about constellations.

Ref. 62 Taurus and Sirius in Canis Major are examples of stars whose size has been measured; they are all only a few light years from Earth. Of course, like the Sun, all other stars have a finite size, but one cannot prove this by measuring dimensions in photographs. (True?)

Challenge 138 s

Challenge 139 e The difference between ‘point-like’ and finite size sources can be seen with the naked eye: at night, stars twinkle, but planets do not. (Check it!) This effect is due to the turbulence of air. Turbulence has an effect on the almost point-like stars because it deflects light rays by small amounts. On the other hand, air turbulence is too weak to lead to twinkling of sources of larger angular size, such as planets or artificial satellites,\* because the deflection is averaged out in this case.

Challenge 140 s An object is *point-like for the naked eye* if its angular size is smaller than about  $2' = 0.6$  mrad. Can you estimate the size of a ‘point-like’ dust particle? By the way, an object is *invisible* to the naked eye if it is point-like *and* if its luminosity, i.e., the intensity of the light from the object reaching the eye, is below some critical value. Can you estimate whether there are any man-made objects visible from the Moon, or from the space shuttle?

Challenge 141 s

Challenge 142 s The above definition of ‘point-like’ in everyday life is obviously misleading. Do proper, real point particles exist? In fact, is it at all possible to show that a particle has vanishing size? This question will be central in the last two parts of our walk. In the same way, we need to ask and check whether points in space do exist. Our walk will lead us to the astonishing result that all the answers to these questions are negative. Can you imagine why? Do not be disappointed if you find this issue difficult; many brilliant minds have had the same problem.

However, many particles, such as electrons, quarks or photons are point-like for all practical purposes. Once one knows how to describe the motion of point particles, one can also describe the motion of extended bodies, rigid or deformable, by assuming that they are made of parts. This is the same approach as describing the motion of an animal as a whole by combining the motion of its various body parts. The simplest description, the *continuum approximation*, describes extended bodies as an infinite collection of point particles. It allows us to understand and to predict the motion of milk and honey, the motion of the air in hurricanes and of perfume in rooms. The motion of fire and all other gaseous bodies, the bending of bamboo in the wind, the shape changes of chewing gum, and the growth of plants and animals can also be described in this way.

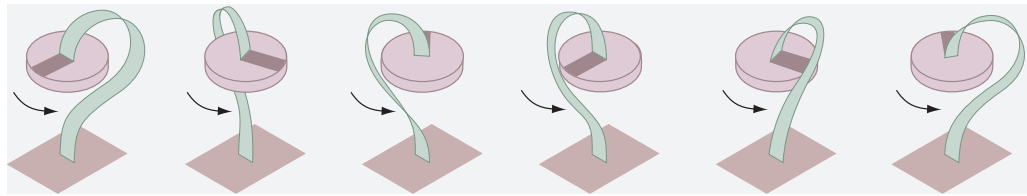
Ref. 63

Vol. IV, page 13 A more precise description than the continuum approximation is given below. Nevertheless, all observations so far have confirmed that the motion of large bodies can be described to high precision as the result of the motion of their parts. This approach will guide us through the first five volumes of our mountain ascent. Only in the final volume will we discover that, at a fundamental scale, this decomposition is impossible.

---

For an overview of the planets, see the beautiful book by K. R. LANG & C. A. WHITNEY, *Vagabonds de l'espace – Exploration et découverte dans le système solaire*, Springer Verlag, 1993. The most beautiful pictures of the stars can be found in D. MALIN, *A View of the Universe*, Sky Publishing and Cambridge University Press, 1993.

\* A *satellite* is an object circling a planet, like the Moon; an *artificial satellite* is a system put into orbit by humans, like the Sputniks.



**FIGURE 51** How an object can rotate continuously without tangling up the connection to a second object.

### LEGS AND WHEELS

The parts of a body determine its shape. Shape is an important aspect of bodies: among other things, it tells us how to count them. In particular, living beings are always made of a single body. This is not an empty statement: from this fact we can deduce that animals cannot have wheels or propellers, but only legs, fins, or wings. Why?

Living beings have only one surface; simply put, they have only one piece of skin. Mathematically speaking, animals are *connected*. This is often assumed to be obvious, and it is often mentioned that the blood supply, the nerves and the lymphatic connections to a rotating part would get tangled up. However, this argument is not so simple, as **Figure 51** shows. It shows that it is indeed possible to rotate a body continuously against a second one, without tangling up the connections. Can you find an example for this kind of motion in your own body? Are you able to see how many cables may be attached to the rotating body of the figure without hindering the rotation?

Vol. V, page 285

Ref. 64

Challenge 143 s

Challenge 144 s

Challenge 145 s

Ref. 65

Despite the possibility of animals having rotating parts, the method of **Figure 51** still cannot be used to make a practical wheel or propeller. Can you see why? Evolution had no choice: it had to avoid animals with parts rotating around axles. That is the reason that propellers and wheels do not exist in nature. Of course, this limitation does not rule out that living bodies move by rotation as a whole: tumbleweed, seeds from various trees, some insects, several spiders,\* certain other animals, children and dancers occasionally move by rolling or rotating as a whole.

Ref. 66

Ref. 67

*Single* bodies, and thus all living beings, can only move through *deformation* of their shape: therefore they are limited to walking, running, rolling, crawling or flapping wings or fins. Extreme examples of leg use in nature are shown in **Figure 52**. The most extreme example (not shown) are rolling spiders living in the sand in Morocco; they use their legs to accelerate and steer the rolling direction. Walking on water is shown in **Figure 102** on **page 138**; examples of wings are given later on, as are the various types of deformations that allow swimming in water. In contrast, systems of several bodies, such as bicycles, pedal boats or other machines, can move *without* any change of shape of their components, thus enabling the use of axles with wheels, propellers or other rotating devices.\*\*

Vol. V, page 205

Vol. V, page 207

\* Rolling is known for desert spiders of the *Cebrennus* and the *Carparachne* genus; films can be found on [www.youtube.com/watch?v=5XwIXFFVOSA](http://www.youtube.com/watch?v=5XwIXFFVOSA) and [www.youtube.com/watch?v=ozn31QBOHtk](http://www.youtube.com/watch?v=ozn31QBOHtk). *Cebrennus* seems even to be able to accelerate with its legs.

\*\* Despite the disadvantage of not being able to use rotating parts and of being restricted to one piece only, nature's moving constructions, usually called animals, often outperform human built machines. As an example, compare the size of the smallest flying systems built by evolution with those built by humans. (See, e.g. [pixelito.reference.be](http://pixelito.reference.be).) There are two reasons for this discrepancy. First, nature's systems have integrated





**FIGURE 52** Legs and 'wheels' in living beings: the red millipede *Aphistogoniulus erythrocephalus* (15 cm body length), a gekko on a glass pane (15 cm body length), an amoeba *Amoeba proteus* (1 mm size), the rolling shrimp *Nannosquilla decemspinosa* (2 cm body length, 1.5 rotations per second, up to 2 m, can even roll slightly uphill slopes) and the rolling caterpillar *Pleurotya ruralis* (can only roll downhill, to escape predators), (© David Parks, Marcel Berendsen, Antonio Guillén, Robert Full, John Brackenburg / Science Photo Library).

In summary, whenever we observe a construction in which some part is turning continuously (and without the 'wiring' of the figure) we know immediately that it is an artefact: it is a machine, not a living being (but built by one). However, like so many statements about living creatures, this one also has exceptions. The distinction between one and two bodies is poorly defined if the whole system is made of only a few molecules. This happens most clearly inside bacteria. Organisms such as *Escherichia coli*, the well-known bacterium found in the human gut, or bacteria from the *Salmonella* family, all swim using flagella. *Flagella* are thin filaments, similar to tiny hairs that stick out of the cell membrane. In the 1970s it was shown that each flagellum, made of one or a few long molecules with a diameter of a few tens of nanometres, does in fact turn about its axis. A bacterium is able to turn its flagella in both clockwise and anticlockwise directions, can achieve more than 1000 turns per second, and can turn all its flagella in perfect synchronization. (These wheels are so tiny that they do not need a mechanical connection.) Therefore wheels actually do exist in living beings, albeit only tiny ones. But let us

Vol. V, page 207

Ref. 68

Challenge 146 s

repair and maintenance systems. Second, nature can build large structures inside containers with small openings. In fact, nature is very good at what people do when they build sailing ships inside glass bottles. The human body is full of such examples; can you name a few?



**FIGURE 53** Are comets, such as the beautiful comet McNaught seen in 2007, images or bodies? How can one settle the issue? (© Robert McNaught)

now continue with our study of simple objects.

### CURIOSITIES AND FUN CHALLENGES ABOUT KINEMATICS

Challenge 147 s What is the biggest wheel ever made?

\* \*

A soccer ball is shot, by a goalkeeper, with around 30 m/s. Calculate the distance it should fly and compare it with the distances found in a soccer match. Where does the difference come from?

Challenge 148 s

\* \*

A train starts to travel at a constant speed of 10 m/s between two cities A and B, 36 km apart. The train will take one hour for the journey. At the same time as the train, a fast dove starts to fly from A to B, at 20 m/s. Being faster than the train, the dove arrives at B first. The dove then flies back towards A; when it meets the train, it turns back again, to city B. It goes on flying back and forward until the train reaches B. What distance did the dove cover?

Challenge 149 e

\* \*

Balance a pencil vertically (tip upwards!) on a piece of paper near the edge of a table. How can you pull out the paper without letting the pencil fall?

Challenge 150 e





FIGURE 54 Observation of sonoluminescence (© Detlev Lohse).

Challenge 151 e

Is a return flight by plane – from a point A to B and back to A – faster if the wind blows or if it does not?

\* \*

\* \*

The level of acceleration a human can survive depends on the duration over which one is subjected to it. For a tenth of a second,  $30 g = 300 \text{ m/s}^2$ , as generated by an ejector seat in an aeroplane, is acceptable. (It seems that the record acceleration a human has survived is about  $80 g = 800 \text{ m/s}^2$ .) But as a rule of thumb it is said that accelerations of  $15 g = 150 \text{ m/s}^2$  or more are fatal.

\* \*

Ref. 69

Ref. 70

The highest *microscopic* accelerations are observed in particle collisions, where one gets values up to  $10^{35} \text{ m/s}^2$ . The highest *macroscopic* accelerations are probably found in the collapsing interiors of *supernovae*, exploding stars which can be so bright as to be visible in the sky even during the daytime. A candidate on Earth is the interior of collapsing bubbles in liquids, a process called *cavitation*. Cavitation often produces light, an effect discovered by Frenzel and Schulte in 1934 and called *sonoluminescence*. (See Figure 54.) It appears most prominently when air bubbles in water are expanded and contracted by underwater loudspeakers at around 30 kHz and allows precise measurements of bubble motion. At a certain threshold intensity, the bubble radius changes at 1500 m/s in as little as a few  $\mu\text{m}$ , giving an acceleration of several  $10^{11} \text{ m/s}^2$ .

\* \*

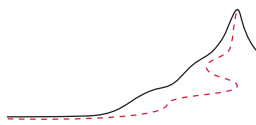
Legs are easy to build. Nature has even produced a millipede, *Illacme plenipes*, that has 750 legs. The animal is 3 to 4 cm long and about 0.5 mm wide. This seems to be the record so far.

### SUMMARY OF KINEMATICS

The description of everyday motion of mass points with three coordinates as  $(x(t), y(t), z(t))$  is simple, precise and complete. It assumes that objects can be fol-

lowed along their paths. Therefore, the description does not work for an important case: the motion of images.





## CHAPTER 4

# FROM OBJECTS AND IMAGES TO CONSERVATION

Walking through a forest we observe two rather different types of motion: the breeze moves the leaves, and at the same time their shadows move on the ground. Shadows are a simple type of image. Both objects and images are able to move. Running tigers, falling snowflakes, and material ejected by volcanoes are examples of motion, since they all change position over time. For the same reason, the shadow following our body, the beam of light circling the tower of a lighthouse on a misty night, and the rainbow that constantly keeps the same apparent distance from the hiker are examples of motion.

Ref. 71

Everybody who has ever seen an animated cartoon knows that images can move in more surprising ways than objects. Images can change their size, shape and even colour, a feat only few objects are able to perform.\* Images can appear and disappear without trace, multiply, interpenetrate, go backwards in time and defy gravity or any other force. Images, even ordinary shadows, can move faster than light. Images can float in space and keep the same distance from approaching objects. Objects can do almost none of this. In general, the ‘laws of cartoon physics’ are rather different from those in nature. In fact, the motion of images does not seem to follow any rules, in contrast to the motion of objects. On the other hand, both objects and images differ from their environment in that they have *boundaries* defining their size and shape. We feel the need for precise criteria allowing the two cases to be distinguished.

Ref. 73

Making a clear distinction between images and objects is performed using the same method that children or animals use when they stand in front of a mirror for the first time: they try to *touch* what they see. Indeed, if we are able to touch what we see – or more precisely, if we are able to move it – we call it an *object*, otherwise an *image*.\*\* Images cannot be touched, but objects can. Images cannot hit each other, but objects can. And as everybody knows, touching something means feeling that it resists movement.

Vol. IV, page 115

Challenge 152 s

Ref. 72

\* Excluding very slow changes such as the change of colour of leaves in the Fall, in nature only certain crystals, the octopus, the chameleon and a few other animals achieve this. Of man-made objects, television, computer displays, heated objects and certain lasers can do it. Do you know more examples? An excellent source of information on the topic of colour is the book by K. NASSAU, *The Physics and Chemistry of Colour – the fifteen causes of colour*, J. Wiley & Sons, 1983. In the popular science domain, the most beautiful book is the classic work by the Flemish astronomer MARCEL G. J. MINNAERT, *Light and Colour in the Outdoors*, Springer, 1993, an updated version based on his wonderful book series, *De natuurkunde van ‘t vrije veld*, Thieme & Cie, 1937. Reading it is a must for all natural scientists. On the web, there is also the – simpler, but excellent – [webexhibits.org/causesofcolour](http://webexhibits.org/causesofcolour) website.

\*\* One could propose including the requirement that objects may be rotated; however, this requirement gives difficulties in the case of atoms, as explained on [page 71](#), and with elementary particles, so that rotation is not made a separate requirement.

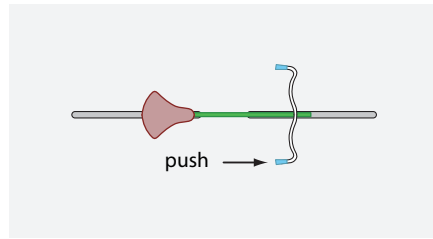


FIGURE 55 In which direction does the bicycle turn?

Certain bodies, such as butterflies, pose little resistance and are moved with ease, others, such as ships, resist more, and are moved with more difficulty. This resistance to motion – more precisely, to change of motion – is called *inertia*, and the difficulty with which a body can be moved is called its (*inertial*) *mass*. Images have neither inertia nor mass.

Challenge 153 s

Summing up, for the description of motion we must distinguish bodies, which can be touched and are impenetrable, from images, which cannot and are not. Everything visible is either an object or an image; there is no third possibility. (Do you agree?) If the object is so far away that it cannot be touched, such as a star or a comet, it can be difficult to decide whether one is dealing with an image or an object; we will encounter this difficulty repeatedly. For example, how would you show that comets are objects and not images, as Galileo claimed?

Challenge 154 s

Ref. 74

In the same way that objects are made of *matter*, images are made of *radiation*. Images are the domain of shadow theatre, cinema, television, computer graphics, belief systems and drug experts. Photographs, motion pictures, ghosts, angels, dreams and many hallucinations are images (sometimes coupled with brain malfunction). To understand images, we need to study radiation (plus the eye and the brain). However, due to the importance of objects – after all we are objects ourselves – we study the latter first.

## MOTION AND CONTACT

Ref. 75

“Democritus affirms that there is only one type of movement: That resulting from collision.”  
Aetius, *Opinions*.

When a child rides a monocycle, she or he makes use of a general rule in our world: one body acting on another puts it in motion. Indeed, in about six hours, anybody can learn to ride and enjoy a monocycle. As in all of life's pleasures, such as toys, animals, women, machines, children, men, the sea, wind, cinema, juggling, rambling and loving, something pushes something else. Thus our first challenge is to describe this transfer of motion in more precise terms.

Contact is not the only way to put something into motion; a counter-example is an apple falling from a tree or one magnet pulling another. Non-contact influences are more fascinating: nothing is hidden, but nevertheless something mysterious happens. Contact motion seems easier to grasp, and that is why one usually starts with it. However, despite this choice, non-contact forces are not easily avoided. Taking this choice one has a similar experience to that of cyclists. (See Figure 55.) If you ride a bicycle at a sustained speed and try to turn left by pushing the right-hand steering bar, you will turn *right*. By the

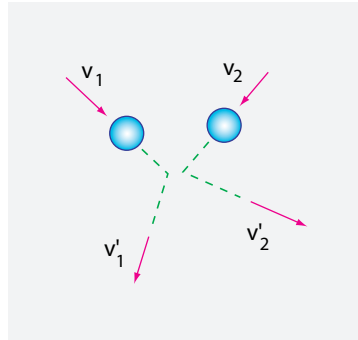


FIGURE 56 Collisions define mass.



FIGURE 57 The standard kilogram (© BIPM).

### Challenge 155 s

way, this surprising effect, also known to motor bike riders, obviously works only above a certain minimal speed. Can you determine what this speed is? Be careful! Too strong a push will make you fall.

Something similar will happen to us as well; despite our choice for contact motion, the rest of our walk will rapidly force us to study non-contact interactions.

### WHAT IS MASS?

“ Δός μοι ποῦ στῶ καὶ κινῶ τὴν γῆν.  
Da ubi consistam, et terram movebo.\* ”  
Archimedes

When we push something we are unfamiliar with, such as when we kick an object on the street, we automatically pay attention to the same aspect that children explore when they stand in front of a mirror for the first time, or when they see a red laser spot for the first time. They check whether the unknown entity can be pushed, and they pay attention to how the unknown object moves under their influence. The high precision version of the experiment is shown in Figure 56. Repeating the experiment with various pairs of objects, we find – as in everyday life – that a fixed quantity  $m_i$  can be ascribed to every object  $i$ . The more difficult it is to move an object, the higher the quantity; it is determined by the relation

$$\frac{m_2}{m_1} = -\frac{\Delta v_1}{\Delta v_2} \quad (15)$$

Ref. 76 \* ‘Give me a place to stand, and I’ll move the Earth.’ Archimedes (c. 283–212), Greek scientist and engineer. This phrase was attributed to him by Pappus. Already Archimedes knew that the distinction used by lawyers between movable and immovable property made no sense.



FIGURE 58 Antoine Lavoisier (1743–1794) and his wife.

where  $\Delta v$  is the velocity change produced by the collision. The number  $m_i$  is called the *mass* of the object  $i$ .

In order to have mass values that are common to everybody, the mass value for one particular, selected object has to be fixed in advance. This special object, shown in [Figure 57](#) is called the *standard kilogram* and is kept with great care in a glass container in Sèvres near Paris. The standard kilogram is touched only once every few years because otherwise dust, humidity, or scratches would change its mass. By the way, the standard kilogram is *not* kept under vacuum, because this would lead to outgassing and thus to changes in its mass. Through the standard kilogram the value of the mass of every other object in the world is determined.

Ref. 61 The mass thus measures the difficulty of getting something moving. High masses are harder to move than low masses. Obviously, only objects have mass; images don't. (By the way, the word 'mass' is derived, via Latin, from the Greek  $\mu\alpha\zeta\alpha$  – bread – or the Hebrew 'mazza' – unleavened bread. That is quite a change in meaning.)

Experiments with everyday life objects also show that throughout any collision, the sum of all masses is *conserved*:

$$\sum_i m_i = \text{const} . \quad (16)$$

The principle of conservation of mass was first stated by Antoine-Laurent Lavoisier.\* Conservation of mass also implies that the mass of a composite system is the sum of the mass of the components. In short, *Galilean mass is a measure for the quantity of matter*.

\* Antoine-Laurent Lavoisier (1743–1794), French chemist and a genius. Lavoisier was the first to understand that combustion is a reaction with oxygen; he discovered the components of water and introduced mass measurements into chemistry. There is a good, but most probably false story about him: When he was (unjustly) sentenced to the guillotine during the French revolution, he decided to use the situations for a scientific experiment. He would try to blink his eyes as frequently as possible after his head was cut off, in order to show others how long it takes to lose consciousness. Lavoisier managed to blink eleven times. It is unclear whether the story is true or not. It is known, however, that it could be true. Indeed, if a decapitated has no pain or shock, he can remain conscious for up to half a minute.

Ref. 77



FIGURE 59 Christiaan Huygens (1629–1695).

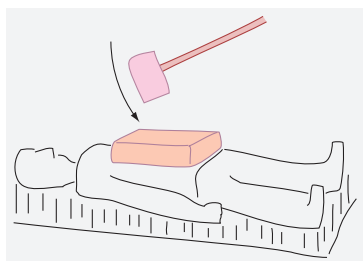


FIGURE 60 Is this dangerous?

### MOMENTUM AND MASS

The definition of mass can also be given in another way. We can ascribe a number  $m_i$  to every object  $i$  such that for collisions free of outside interference the following sum is unchanged *throughout* the collision:

$$\sum_i m_i \mathbf{v}_i = \text{const} . \quad (17)$$

The product of the velocity  $\mathbf{v}_i$  and the mass  $m_i$  is called the *momentum* of the body. The sum, or *total momentum* of the system, is the same before and after the collision; momentum is a *conserved quantity*. *Momentum conservation defines mass*. The two conservation principles (16) and (17) were first stated in this way by the important Dutch physicist Christiaan Huygens.\* Momentum and mass are conserved in everyday motion of objects. Neither quantity can be defined for the motion of images. Some typical momentum values are given in Table 15.

Momentum conservation implies that when a moving sphere hits a resting one of the same mass and without loss of energy, a simple rule determines the angle between the directions the two spheres take after the collision. Can you find this rule? It is particularly useful when playing billiards. We will find out later that it is *not* valid in special relativity.

Another consequence of momentum conservation is shown in Figure 60: a man is

Challenge 156 s

\* Christiaan Huygens (b. 1629 's Gravenhage, d. 1695 Hofwyck) was one of the main physicists and mathematicians of his time. Huygens clarified the concepts of mechanics; he also was one of the first to show that light is a wave. He wrote influential books on probability theory, clock mechanisms, optics and astronomy. Among other achievements, Huygens showed that the Orion Nebula consists of stars, discovered Titan, the moon of Saturn, and showed that the rings of Saturn consist of rock. (This is in contrast to Saturn itself, whose density is lower than that of water.)



TABLE 15 Some measured momentum values.

OBSERVATION	MOMENTUM
Momentum of a green photon	$1.2 \cdot 10^{-27}$ Ns
Average momentum of oxygen molecule in air	$10^{-26}$ Ns
X-ray photon momentum	$10^{-23}$ Ns
$\gamma$ photon momentum	$10^{-17}$ Ns
Highest particle momentum in accelerators	1 fNs
Highest possible momentum of a single elementary particle – the Planck momentum	6.5 Ns
Fast billiard ball	3 Ns
Flying rifle bullet	10 Ns
Box punch	15 to 50 Ns
Comfortably walking human	80 Ns
Lion paw strike	kNs
Whale tail blow	kNs
Car on highway	40 kNs
Impact of meteorite with 2 km diameter	100 TNs
Momentum of a galaxy in galaxy collision	up to $10^{46}$ Ns

## Challenge 157 s

lying on a bed of nails with a large block of concrete on his stomach. Another man is hitting the concrete with a heavy sledgehammer. As the impact is mostly absorbed by the concrete, there is no pain and no danger – unless the concrete is missed. Why?

The above definition of mass has been generalized by the physicist and philosopher Ernst Mach\* in such a way that it is valid even if the two objects interact without contact, as long as they do so along the line connecting their positions. The mass ratio between two bodies is defined as a negative inverse acceleration ratio, thus as

$$\frac{m_2}{m_1} = -\frac{a_1}{a_2}, \quad (18)$$

where  $a$  is the acceleration of each body during the interaction. This definition has been studied in much detail in the physics community, mainly in the nineteenth century. A few points sum up the results:

- The definition of mass *implies* the conservation of total momentum  $\sum mv$ . Momentum conservation is *not* a separate principle. Conservation of momentum cannot be checked experimentally, because mass is defined in such a way that the principle holds.

\* Ernst Mach (1838 Chrlice–1916 Vaterstetten), Austrian physicist and philosopher. The *mach* unit for aeroplane speed as a multiple of the speed of sound in air (about 0.3 km/s) is named after him. He developed the so-called Mach–Zehnder interferometer; he also studied the basis of mechanics. His thoughts about mass and inertia influenced the development of general relativity, and led to Mach's principle, which will appear later on. He was also proud to be the last scientist denying – humorously, and against all evidence – the existence of atoms.

- The definition of mass *implies* the equality of the products  $m_1 a_1$  and  $-m_2 a_2$ . Such products are called *forces*. The equality of acting and reacting forces is not a separate principle; mass is defined in such a way that the principle holds.
- The definition of mass is *independent* of whether contact is involved or not, and whether the origin of the accelerations is due to electricity, gravitation, or other interactions.\* Since the interaction does not enter the definition of mass, mass values defined with the help of the electric, nuclear or gravitational interaction all agree, as long as momentum is conserved. All known interactions conserve momentum. For some unfortunate historical reasons, the mass value measured with the electric or nuclear interactions is called the ‘inertial’ mass and the mass measured using gravity is called the ‘gravitational’ mass. As it turns out, this artificial distinction has no real meaning; this becomes especially clear when one takes an observation point that is far away from all the bodies concerned.
- The definition of mass requires observers at rest or in inertial motion.

By measuring the masses of bodies around us, as given in Table 16, we can explore the science and art of experiments. We also discover the main properties of mass. It is *additive* in everyday life, as the mass of two bodies combined is equal to the sum of the two separate masses. Furthermore, mass is *continuous*; it can seemingly take any positive value. Finally, mass is *conserved*; the mass of a system, defined as the sum of the mass of all constituents, does not change over time if the system is kept isolated from the rest of the world. Mass is not only conserved in collisions but also during melting, evaporation, digestion and all other processes.

Later we will find that in the case of mass all these properties, summarized in Table 17, are only approximate. Precise experiments show that none of them are correct.\*\* For the moment we continue with the present, Galilean concept of mass, as we have not yet a better one at our disposal.

In a famous experiment in the sixteenth century, for several weeks Santorio Santorio (Sanctorius) (1561–1636), friend of Galileo, lived with all his food and drink supply, and also his toilet, on a large balance. He wanted to test mass conservation. How did the measured weight change with time?

Challenge 159 s

The definition of mass through momentum conservation implies that when an object falls, the Earth is accelerated upwards by a tiny amount. If one could measure this tiny amount, one could determine the mass of the Earth. Unfortunately, this measurement is impossible. Can you find a better way to determine the mass of the Earth?

Challenge 160 s

Summarizing Table 17, the mass of a body is thus most precisely described by a *positive* real number, often abbreviated  $m$  or  $M$ . This is a direct consequence of the impenetrability of matter. Indeed, a *negative* (inertial) mass would mean that such a body would move in the opposite direction of any applied force or acceleration. Such a body could not be kept in a box; it would break through any wall trying to stop it. Strangely enough, nega-

Page 103

Challenge 158 s

\* As mentioned above, only *central* forces obey the relation (18) used to define mass. Central forces act between the centre of mass of bodies. We give a precise definition later. However, since all fundamental forces are central, this is not a restriction. There seems to be one notable exception: magnetism. Is the definition of mass valid in this case?

\*\* In particular, in order to define mass we must be able to *distinguish* bodies. This seems a trivial requirement, but we discover that this is not always possible in nature.

TABLE 16 Some measured mass values.

OBSERVATION	MASS
Probably lightest known object: neutrino	$c. 2 \cdot 10^{-36}$ kg
Mass increase due to absorption of one green photon	$4.1 \cdot 10^{-36}$ kg
Lightest known charged object: electron	$9.109\,381\,88(72) \cdot 10^{-31}$ kg
Atom of argon	$39.962\,383\,123(3)$ u = $66.359\,1(1)$ yg
Lightest object ever weighed (a gold particle)	0.39 ag
Human at early age (fertilized egg)	$10^{-8}$ g
Water adsorbed on to a kilogram metal weight	$10^{-5}$ g
Planck mass	$2.2 \cdot 10^{-5}$ g
Fingerprint	$10^{-4}$ g
Typical ant	$10^{-4}$ g
Water droplet	1 mg
Honey bee, <i>Apis mellifera</i>	0.1 g
Euro coin	7.5 g
Blue whale, <i>Balaenoptera musculus</i>	180 Mg
Heaviest living things, such as the fungus <i>Armillaria ostoyae</i> or a large Sequoia <i>Sequoiadendron giganteum</i>	$10^6$ kg
Heaviest train ever	$99.7 \cdot 10^6$ kg
Largest ocean-going ship	$400 \cdot 10^6$ kg
Largest object moved by man (Troll gas rig)	$687.5 \cdot 10^6$ kg
Large antarctic iceberg	$10^{15}$ kg
Water on Earth	$10^{21}$ kg
Earth's mass	$5.98 \cdot 10^{24}$ kg
Solar mass	$2.0 \cdot 10^{30}$ kg
Our galaxy's visible mass	$3 \cdot 10^{41}$ kg
Our galaxy's estimated total mass	$2 \cdot 10^{42}$ kg
virgo supercluster	$2 \cdot 10^{46}$ kg
Total mass visible in the universe	$10^{54}$ kg

Challenge 161 e

tive mass bodies would still fall downwards in the field of a large positive mass (though more slowly than an equivalent positive mass). Are you able to confirm this? However, a small positive mass object would float away from a large negative-mass body, as you can easily deduce by comparing the various accelerations involved. A positive and a negative mass of the same value would stay at constant distance and spontaneously accelerate away along the line connecting the two masses. Note that both energy and momentum are conserved in all these situations.\* Negative-mass bodies have never been observed.

Challenge 162 e

Vol. II, page 65

Page 96

Challenge 163 e

\* For more curiosities, see R. H. PRICE, Negative mass can be positively amusing, *American Journal of Physics* 61, pp. 216–217, 1993. Negative mass particles in a box would heat up a box made of positive mass while traversing its walls, and accelerating, i.e., losing energy, at the same time. They would allow one to build a *perpetuum mobile* of the second kind, i.e., a device circumventing the second principle of thermodynamics. Moreover, such a system would have no thermodynamic equilibrium, because its energy could

TABLE 17 Properties of Galilean mass.

MASSES	PHYSICAL PROPERTY	MATHEMATICAL NAME	DEFINITION
Can be distinguished	distinguishability	element of set	Vol. III, page 195
Can be ordered	sequence	order	Vol. IV, page 190
Can be compared	measurability	metricity	Vol. V, page 276
Can change gradually	continuity	completeness	Vol. V, page 284
Can be added	quantity of matter	additivity	Page 73
Beat any limit	infinity	unboundedness, openness	Vol. III, page 196
Do not change	conservation	invariance	$m = \text{const}$
Do not disappear	impenetrability	positivity	$m \geq 0$

TABLE 18 Some mass sensors.

MEASUREMENT	SENSOR	RANGE
Sense of touch	pressure sensitive cells	1 mg to 500 kg
Doppler effect on light reflected of the object	interferometer	1 mg to 100 g
Precision scale	balance, pendulum, or spring	1 pg to $10^3$ kg
Truck scale	hydraulic balance	1 to $60 \cdot 10^3$ kg
Ship weight	water volume measurement	up to $500 \cdot 10^6$ kg

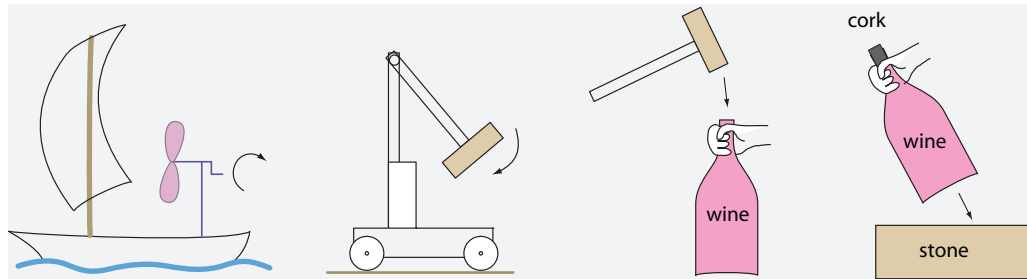


FIGURE 61 Mass measurement devices: a vacuum balance used in 1890 by Dmitriy Ivanovich Mendeleev and a modern laboratory balance (© Thinktank Trust, Mettler-Toledo).

Vol. IV, page 162 Antimatter, which will be discussed later, also has positive mass.

Challenge 164 s

decrease forever. The more one thinks about negative mass, the more one finds strange properties contradicting observations. By the way, what is the range of possible mass values for tachyons?



Challenge 165 s **FIGURE 62** What happens in these four situations?

### IS MOTION ETERNAL? – CONSERVATION OF MOMENTUM

“Every body continues in the state of rest or of uniform motion in a straight line except in so far as it doesn’t.”  
Arthur Eddington\*

The product  $\mathbf{p} = m\mathbf{v}$  of mass and velocity is called the *momentum* of a particle; it describes the tendency of an object to keep moving during collisions. The larger it is, the harder it is to stop the object. Like velocity, momentum has a direction and a magnitude: it is a vector. In French, momentum is called ‘quantity of motion’, a more appropriate term. In the old days, the term ‘motion’ was used instead of ‘momentum’, for example by Newton. Relation (17), the conservation of momentum, therefore expresses the conservation of motion during interactions.

Momentum, like energy is an *extensive quantity*. That means that it can be said that both *flow* from one body to the other, and that they can be *accumulated* in bodies, in the same way that water flows and can be accumulated in containers. Imagining momentum as something that can be *exchanged* between bodies in collisions is always useful when thinking about the description of moving objects.

Momentum is conserved. That explains the limitations you might experience when being on a perfectly frictionless surface, such as ice or a polished, oil covered marble: you cannot propel yourself forward by patting your own back. (Have you ever tried to put a cat on such a marble surface? It is not even able to stand on its four legs. Neither are humans. Can you imagine why?) Momentum conservation also answers the puzzles of Figure 62.

Challenge 166 s

Challenge 167 s

The conservation of momentum and mass also means that teleportation (‘beam me up’) is impossible in nature. Can you explain this to a non-physicist?

Momentum conservation implies that momentum can be imagined to be like an invisible fluid. In an interaction, the invisible fluid is transferred from one object to another. However, the sum is always constant.

Momentum conservation implies that motion never stops; it is only *exchanged*. On the other hand, motion often ‘disappears’ in our environment, as in the case of a stone dropped to the ground, or of a ball left rolling on grass. Moreover, in daily life we often observe the creation of motion, such as every time we open a hand. How do these examples fit with the conservation of momentum?

\* Arthur Eddington (1882–1944), British astrophysicist.

It turns out that the answer lies in the microscopic aspects of these systems. A muscle only *transforms* one type of motion, namely that of the electrons in certain chemical compounds\* into another, the motion of the fingers. The working of muscles is similar to that of a car engine transforming the motion of electrons in the fuel into motion of the wheels. Both systems need fuel and get warm in the process.

We must also study the microscopic behaviour when a ball rolls on grass until it stops. The disappearance of motion is called *friction*. Studying the situation carefully, one finds that the grass and the ball heat up a little during this process. During friction, visible motion is transformed into heat. Later, when we discover the structure of matter, it will become clear that heat is the disorganized motion of the microscopic constituents of every material. When these constituents all move in the same direction, the object as a whole moves; when they oscillate randomly, the object is at rest, but is warm. Heat is a form of motion. Friction thus only seems to be disappearance of motion; in fact it is a transformation of ordered into unordered motion.

Despite momentum conservation, *macroscopic* perpetual motion does not exist, since friction cannot be completely eliminated.\*\* Motion is eternal only at the microscopic scale. In other words, the disappearance and also the spontaneous appearance of motion in everyday life is an illusion due to the limitations of our senses. For example, the motion proper of every living being exists before its birth, and stays after its death. The same happens with its energy. This result is probably the closest one can get to the idea of everlasting life from evidence collected by observation. It is perhaps less than a coincidence that energy used to be called *vis viva*, or ‘living force’, by Leibniz and many others.

Since motion is conserved, it has no origin. Therefore, at this stage of our walk we cannot answer the fundamental questions: Why does motion exist? What is its origin? The end of our adventure is nowhere near.

#### MORE CONSERVATION – ENERGY

When collisions are studied in detail, a second conserved quantity turns up. Experiments show that in the case of perfect, or elastic collisions – collisions without friction – the

Ref. 78 \* Usually adenosine triphosphate (ATP), the fuel of most processes in animals.

\*\* Some funny examples of past attempts to build a *perpetual motion machine* are described in STANISLAV MICHEL, *Perpetuum mobile*, VDI Verlag, 1976. Interestingly, the idea of eternal motion came to Europe from India, via the Islamic world, around the year 1200, and became popular as it opposed the then standard view that all motion on Earth disappears over time. See also the [web.archive.org/web/20040812085618/http://www.geocities.com/mercutio78\\_99/pmm.html](http://www.geocities.com/mercutio78_99/pmm.html) and the [www.lhup.edu/~dsimanek/museum/unwork.htm](http://www.lhup.edu/~dsimanek/museum/unwork.htm) websites. The conceptual mistake made by eccentrics and used by crooks is always the same: the hope of overcoming friction. (In fact, this applied only to the perpetual motion machines of the second kind; those of the first kind – which are even more in contrast with observation – even try to generate energy from nothing.)

Ref. 79 If the machine is well constructed, i.e., with little friction, it can take the little energy it needs for the sustenance of its motion from very subtle environmental effects. For example, in the Victoria and Albert Museum in London one can admire a beautiful clock powered by the variations of air pressure over time.

Challenge 168 s Low friction means that motion takes a long time to stop. One immediately thinks of the motion of the planets. In fact, there *is* friction between the Earth and the Sun. (Can you guess one of the mechanisms?) But the value is so small that the Earth has already circled around the Sun for thousands of millions of years, and will do so for quite some time more.



FIGURE 63 Robert Mayer (1814–1878).

following quantity, called the *kinetic energy*  $T$  of the system, is also conserved:

$$T = \sum_i \frac{1}{2} m_i v_i^2 = \sum_i \frac{1}{2} m_i v_i^2 = \text{const} . \quad (19)$$

Kinetic energy is the ability that a body has to induce change in bodies it hits. Kinetic energy thus depends on the mass and on the square of the speed  $v$  of a body. The full name ‘kinetic energy’ was introduced by Gustave-Gaspard Coriolis.\*

Energy is a word taken from ancient Greek; originally it was used to describe character, and meant ‘intellectual or moral vigour’. It was taken into physics by Thomas Young (1773–1829) in 1807 because its literal meaning is ‘force within’. (The letters  $E$ ,  $W$ ,  $A$  and several others are also used to denote energy.) Another, equivalent definition of energy will become clear later: energy is what can be transformed into heat.

(Physical) *energy* is the measure of the ability to generate motion. A body has a lot of energy if it has the ability to move many other bodies. Energy is a single number; it has no direction. The total momentum of two equal masses moving with opposite velocities is zero; their total energy increases with velocity. Energy thus also measures motion, but in a different way than momentum. Energy measures motion in a more global way. An equivalent definition is the following. Energy is the ability to perform work. Here, the physical concept of work is just the precise version of what is meant by work in everyday life.\*\*

Do not be surprised if you do not grasp the difference between momentum and energy straight away: physicists took about two centuries to figure it out. For some time they even insisted on using the same word for both, and often they didn’t know which situation required which concept. So you are allowed to take a few minutes to get used to it.

Both energy and momentum measure how systems change. Momentum tells how systems change over distance, energy measures how systems change over time. Momentum is needed to compare motion here and there. Energy is needed to compare motion now and later. Some measured energy values are given in Table 19.

One way to express the difference between energy and momentum is to think about

\* Gustave-Gaspard Coriolis (b. 1792 Paris, d. 1843 Paris), French engineer and mathematician. He introduced the modern concepts of ‘work’ and of ‘kinetic energy’, and discovered the Coriolis effect. Coriolis also introduced the factor  $1/2$ , in order that the relation  $dT/dv = p$  would be obeyed. (Why?)

\*\* (Physical) *work* is the product of force and distance in direction of the force. In other words, work is the *scalar product* of force and distance.



TABLE 19 Some measured energy values.

OBSERVATION	ENERGY
Average kinetic energy of oxygen molecule in air	6 zJ
Green photon energy	0.37 aJ
X-ray photon energy	1 fJ
$\gamma$ photon energy	1 pJ
Highest particle energy in accelerators	0.1 $\mu$ J
Kinetic energy of a flying mosquito	0.2 $\mu$ J
Comfortably walking human	20 J
Flying arrow	50 J
Right hook in boxing	50 J
Energy in torch battery	1 kJ
Energy in explosion of 1 g TNT	4.1 kJ
Energy of 1 kcal	4.18 kJ
Flying rifle bullet	10 kJ
One gram of fat	38 kJ
One gram of gasoline	44 kJ
Apple digestion	0.2 MJ
Car on highway	0.3 to 1 MJ
Highest laser pulse energy	1.8 MJ
Lightning flash	up to 1 GJ
Planck energy	2.0 GJ
Small nuclear bomb (20 ktonne)	84 TJ
Earthquake of magnitude 7	2 PJ
Largest nuclear bomb (50 Mtonne)	210 PJ
Impact of meteorite with 2 km diameter	1 EJ
Yearly machine energy use	420 EJ
Rotation energy of Earth	$2 \cdot 10^{29}$ J
Supernova explosion	$10^{44}$ J
Gamma ray burst	up to $10^{47}$ J
Energy content $E = mc^2$ of Sun's mass	$1.8 \cdot 10^{47}$ J
Energy content of Galaxy's central black hole	$4 \cdot 10^{53}$ J

the following challenges. Is it more difficult to stop a running man with mass  $m$  and speed  $v$ , or one with mass  $m/2$  and speed  $2v$ , or one with mass  $m/2$  and speed  $\sqrt{2}v$ ? You may want to ask a rugby-playing friend for confirmation.

Challenge 170 e

Another distinction is illustrated by athletics: the *real* long jump world record, almost 10 m, is still kept by an athlete who in the early twentieth century ran with two weights in his hands, and then threw the weights behind him at the moment he took off. Can you explain the feat?

Challenge 171 s

When a car travelling at 100 m/s runs head-on into a parked car of the same kind and make, which car receives the greatest damage? What changes if the parked car has its

Challenge 172 s

brakes on?

To get a better feeling for energy, here is an additional approach. The world consumption of energy by human machines (coming from solar, geothermal, biomass, wind, nuclear, hydro, gas, oil, coal, or animal sources) in the year 2000 was about 420 EJ,\* for a world population of about 6000 million people. To see what this energy consumption means, we translate it into a personal power consumption; we get about 2.2 kW. The watt W is the unit of power, and is simply defined as  $1 \text{ W} = 1 \text{ J/s}$ , reflecting the definition of (*physical*) *power* as energy used per unit time. (The precise wording is: power is energy flowing per time through a defined closed surface.) As a working person can produce mechanical work of about 100 W, the average human energy consumption corresponds to about 22 humans working 24 hours a day. (See Table 20 for some power values found in nature.) In particular, if we look at the energy consumption in First World countries, the average inhabitant there has machines working for them equivalent to several hundred ‘servants’. Can you point out some of these machines?

Challenge 173 s

Kinetic energy is thus not conserved in everyday life. For example, in non-elastic collisions, such as that of a piece of chewing gum hitting a wall, kinetic energy is lost. *Friction* destroys kinetic energy. At the same time, friction produces heat. It was one of the important conceptual discoveries of physics that *total* energy is conserved if one includes the discovery that heat is a form of energy. Friction is thus in fact a process transforming kinetic energy, i.e., the energy connected with the motion of a body, into heat. On a microscopic scale, energy is conserved.\*\* Indeed, without energy conservation, the concept of time would not be definable. We will show this connection shortly.

In summary, in addition to mass and momentum, everyday linear motion also conserves energy. To discover the last conserved quantity, we explore another type of motion: rotation.

### THE CROSS PRODUCT, OR VECTOR PRODUCT

The discussion of rotation is easiest if we introduce an additional way to multiply vectors. This new product is called the *cross product* or *vector product*  $\mathbf{a} \times \mathbf{b}$  between two vectors  $\mathbf{a}$  and  $\mathbf{b}$ .

The result of the vector product is another vector; thus it differs from the *scalar* product, whose result is a scalar, i.e., a number. The result of the vector product is that vector that is orthogonal to both vectors to be multiplied, whose orientation is given by the *right-hand rule*, and whose length is given by  $ab \sin \angle(\mathbf{a}, \mathbf{b})$ , i.e., by the surface area of the parallelogram spanned by the two vectors.

Page 347 \* For the explanation of the abbreviation E, see Appendix B.

\*\* In fact, the conservation of energy was stated in its full generality in public only in 1842, by Julius Robert Mayer. He was a medical doctor by training, and the journal *Annalen der Physik* refused to publish his paper, as it supposedly contained ‘fundamental errors’. What the editors called errors were in fact mostly – but not only – contradictions of their prejudices. Later on, Helmholtz, Thomson-Kelvin, Joule and many others acknowledged Mayer’s genius. However, the first to have stated energy conservation in its modern form was the French physicist Sadi Carnot (1796–1832) in 1820. To him the issue was so clear that he did not publish the result. In fact he went on and discovered the second ‘law’ of thermodynamics. Today, energy conservation, also called the first ‘law’ of thermodynamics, is one of the pillars of physics, as it is valid in all its domains.

TABLE 20 Some measured power values.

OBSERVATION	POWER
Radio signal from the Galileo space probe sending from Jupiter	10 zW
Power of flagellar motor in bacterium	0.1 pW
Power consumption of a typical cell	1 pW
sound power at the ear at hearing threshold	2.5 pW
CR-R laser, at 780 nm	40-80 mW
Sound output from a piano playing fortissimo	0.4 W
Incandescent light bulb light output	1 to 5 W
Incandescent light bulb electricity consumption	25 to 100 W
A human, during one work shift of eight hours	100 W
One horse, for one shift of eight hours	300 W
Eddy Merckx, the great bicycle athlete, during one hour	500 W
Metric horse power power unit ( $75 \text{ kg} \cdot 9.81 \text{ m/s}^2 \cdot 1 \text{ m/s}$ )	735.5 W
British horse power power unit	745.7 W
Large motorbike	100 kW
Electrical power station output	0.1 to 6 GW
World's electrical power production in 2000 <a href="#">Ref. 80</a>	450 GW
Power used by the geodynamo	200 to 500 GW
Input on Earth surface: Sun's irradiation of Earth <a href="#">Ref. 81</a>	0.17 EW
Input on Earth surface: thermal energy from inside of the Earth	32 TW
Input on Earth surface: power from tides (i.e., from Earth's rotation)	3 TW
Input on Earth surface: power generated by man from fossil fuels	8 to 11 TW
Lost from Earth surface: power stored by plants' photosynthesis	40 TW
World's record laser power	1 PW
Output of Earth surface: sunlight reflected into space	0.06 EW
Output of Earth surface: power radiated into space at 287 K	0.11 EW
Peak power of the largest nuclear bomb	5 YW
Sun's output	384.6 YW
Maximum power in nature, $c^5/4G$	$9.1 \cdot 10^{51} \text{ W}$

The definition implies that the cross product vanishes if and only if the vectors are parallel. From the definition you can show that the vector product has the properties

Challenge 174 e

$$\begin{aligned}
 \mathbf{a} \times \mathbf{b} &= -\mathbf{b} \times \mathbf{a}, & \mathbf{a} \times (\mathbf{b} + \mathbf{c}) &= \mathbf{a} \times \mathbf{b} + \mathbf{a} \times \mathbf{c}, \\
 \lambda \mathbf{a} \times \mathbf{b} &= \lambda(\mathbf{a} \times \mathbf{b}) = \mathbf{a} \times \lambda \mathbf{b}, & \mathbf{a} \times \mathbf{a} &= \mathbf{0}, \\
 \mathbf{a}(\mathbf{b} \times \mathbf{c}) &= \mathbf{b}(\mathbf{c} \times \mathbf{a}) = \mathbf{c}(\mathbf{a} \times \mathbf{b}), & \mathbf{a} \times (\mathbf{b} \times \mathbf{c}) &= \mathbf{b}(\mathbf{a} \cdot \mathbf{c}) - \mathbf{c}(\mathbf{a} \cdot \mathbf{b}), \\
 (\mathbf{a} \times \mathbf{b})(\mathbf{c} \times \mathbf{d}) &= \mathbf{a}(\mathbf{b} \times (\mathbf{c} \times \mathbf{d})) = (\mathbf{a} \cdot \mathbf{c})(\mathbf{b} \cdot \mathbf{d}) - (\mathbf{b} \cdot \mathbf{c})(\mathbf{a} \cdot \mathbf{d}), \\
 (\mathbf{a} \times \mathbf{b}) \times (\mathbf{c} \times \mathbf{d}) &= \mathbf{c}((\mathbf{a} \times \mathbf{b}) \cdot \mathbf{d}) - \mathbf{d}((\mathbf{a} \times \mathbf{b}) \cdot \mathbf{c}), \\
 \mathbf{a} \times (\mathbf{b} \times \mathbf{c}) + \mathbf{b} \times (\mathbf{c} \times \mathbf{a}) + \mathbf{c} \times (\mathbf{a} \times \mathbf{b}) &= \mathbf{0}.
 \end{aligned} \tag{20}$$

TABLE 21 Some power sensors.

MEASUREMENT	SENSOR	RANGE
Heart beat as power meter	deformation sensor and clock	75 to 2 000 W
Fitness power meter	piezoelectric sensor	75 to 2 000 W
Electricity meter at home	rotating aluminium disc	20 to 10 000 W
Power meter for car engine	electromagnetic brake	up to 1 MW
Laser power meter	photoelectric effect in semiconductor	up to 10 GW
Calorimeter for chemical reactions	temperature sensor	up to 1 MW
Calorimeter for particles	light detector	up to a few $\mu\text{J}/\text{ns}$

Vol. IV, page 199

The vector product exists only in vector spaces with *three* dimensions. We will explore more details on this connection later on.

The vector product is useful to describe systems that *rotate* – and (thus) also systems with magnetic forces. The main reason for the usefulness is that the motion of an orbiting body is always perpendicular both to the axis and to the shortest line that connects the body with the axis.

Challenge 175 e

Confirm that the best way to calculate the vector product  $\mathbf{a} \times \mathbf{b}$  component by component is given by the determinant

$$\mathbf{a} \times \mathbf{b} = \begin{vmatrix} \mathbf{e}_x & a_x & b_x \\ \mathbf{e}_y & a_y & b_y \\ \mathbf{e}_z & a_z & b_z \end{vmatrix} \quad \text{or, sloppily} \quad \mathbf{a} \times \mathbf{b} = \begin{vmatrix} + & - & + \\ a_x & a_y & a_z \\ b_x & b_y & b_z \end{vmatrix}. \quad (21)$$

This is easy to remember and easy to perform, both with letters and with numerical values. (Here,  $\mathbf{e}_x$  is the unit basis vector in the  $x$  direction.) Written out, it is equivalent to the relation

$$\mathbf{a} \times \mathbf{b} = (a_y b_z - b_y a_z, b_x a_z - a_x b_z, a_x b_y - b_x a_y) \quad (22)$$

which is harder to remember.

Challenge 176 e

Show that the *parallelepiped* spanned by three arbitrary vectors  $\mathbf{a}$ ,  $\mathbf{b}$  and  $\mathbf{c}$  has the volume  $V = \mathbf{c} \cdot (\mathbf{a} \times \mathbf{b})$ . Show that the *pyramid* or *tetrahedron* formed by the same three vectors has one sixth of that volume.

## ROTATION

Rotation keeps us alive. Without the change of day and night, we would be either fried or frozen to death, depending on our location on our planet. A short exploration of rotation is thus appropriate.

All objects have the ability to rotate. We saw before that a body is described by its reluctance to move; similarly, a body also has a reluctance to turn. This quantity is called its *moment of inertia* and is often abbreviated  $\Theta$  – pronounced ‘theta’. The speed or rate of rotation is described by *angular velocity*, usually abbreviated  $\omega$  – pronounced ‘omega’. A few values found in nature are given in Table 22.

TABLE 22 Some measured rotation frequencies.

OBSERVATION	ANGULAR VELOCITY $\omega = 2\pi/T$
Galactic rotation	$2\pi \cdot 0.14 \cdot 10^{-15} / \text{s}$ $= 2\pi / (220 \cdot 10^6 \text{ a})$
Average Sun rotation around its axis	$2\pi \cdot 3.8 \cdot 10^{-7} / \text{s} = 2\pi / 30 \text{ d}$
Typical lighthouse	$2\pi \cdot 0.08 / \text{s}$
Pirouetting ballet dancer	$2\pi \cdot 3 / \text{s}$
Ship's diesel engine	$2\pi \cdot 5 / \text{s}$
Helicopter rotor	$2\pi \cdot 5.3 / \text{s}$
Washing machine	up to $2\pi \cdot 20 / \text{s}$
Bacterial flagella	$2\pi \cdot 100 / \text{s}$
Fast CD recorder	up to $2\pi \cdot 458 / \text{s}$
Racing car engine	up to $2\pi \cdot 600 / \text{s}$
Fastest turbine built	$2\pi \cdot 10^3 / \text{s}$
Fastest pulsars (rotating stars)	up to at least $2\pi \cdot 716 / \text{s}$
Ultracentrifuge	$> 2\pi \cdot 2 \cdot 10^3 / \text{s}$
Dental drill	up to $2\pi \cdot 13 \cdot 10^3 / \text{s}$
Technical record	$2\pi \cdot 333 \cdot 10^3 / \text{s}$
Proton rotation	$2\pi \cdot 10^{20} / \text{s}$
Highest possible, Planck angular velocity	$2\pi \cdot 10^{35} / \text{s}$

The observables that describe rotation are similar to those describing linear motion, as shown in Table 23. Like mass, the moment of inertia is defined in such a way that the sum of *angular momenta*  $L$  – the product of moment of inertia and angular velocity – is conserved in systems that do not interact with the outside world:

$$\sum_i \Theta_i \omega_i = \sum_i L_i = \text{const} . \quad (23)$$

In the same way that the conservation of linear momentum defines mass, the conservation of angular momentum defines the moment of inertia.

The moment of inertia can be related to the mass and shape of a body. If the body is imagined to consist of small parts or mass elements, the resulting expression is

$$\Theta = \sum_n m_n r_n^2 , \quad (24)$$

where  $r_n$  is the distance from the mass element  $m_n$  to the axis of rotation. Can you confirm the expression? Therefore, the moment of inertia of a body depends on the chosen axis of rotation. Can you confirm that this is so for a brick?

In contrast to the case of mass, there is no conservation of the moment of inertia. The value of the moment of inertia depends on the location of the axis used for its definition.

Challenge 177 e

Challenge 178 s

TABLE 23 Correspondence between linear and rotational motion.

Q U A N T I T Y	L I N E A R M O T I O N		R O T A T I O N A L M O T I O N	
State	time	$t$	time	$t$
	position	$\mathbf{x}$	angle	$\varphi$
	momentum	$\mathbf{p} = m\mathbf{v}$	angular momentum	$\mathbf{L} = \Theta\boldsymbol{\omega}$
	energy	$mv^2/2$	energy	$\Theta\omega^2/2$
Motion	velocity	$\mathbf{v}$	angular velocity	$\boldsymbol{\omega}$
	acceleration	$\mathbf{a}$	angular acceleration	$\boldsymbol{\alpha}$
Reluctance to move	mass	$m$	moment of inertia	$\Theta$
Motion change	force	$m\mathbf{a}$	torque	$\Theta\boldsymbol{\alpha}$

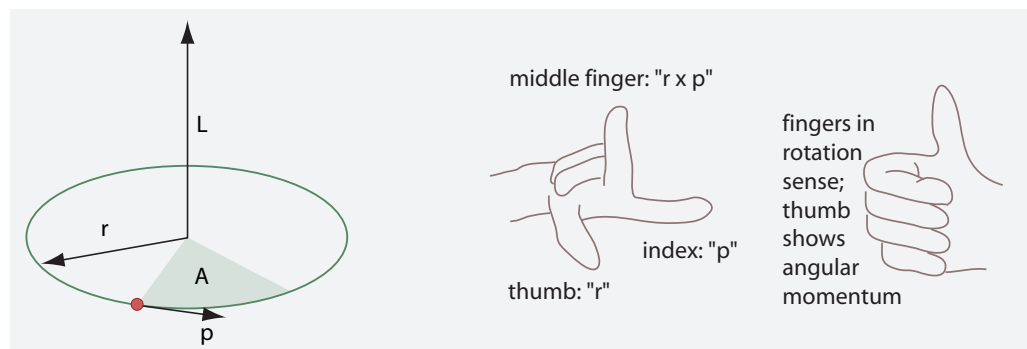


FIGURE 64 Angular momentum and the two versions of the right-hand rule.

For each axis direction, one distinguishes an *intrinsic* moment of inertia, when the axis passes through the centre of mass of the body, from an *extrinsic* moment of inertia, when it does not.\* In the same way, one distinguishes intrinsic and extrinsic angular momenta. (By the way, the *centre of mass* of a body is that imaginary point which moves straight during vertical fall, even if the body is rotating. Can you find a way to determine its location for a specific body?)

Challenge 180 s

We now define the *rotational energy* as

$$E_{\text{rot}} = \frac{1}{2}\Theta \omega^2 = \frac{L^2}{2\Theta} . \tag{26}$$

The expression is similar to the expression for the kinetic energy of a particle. Can you guess how much larger the rotational energy of the Earth is compared with the yearly electricity usage of humanity? In fact, if you could find a way to harness this energy, you

Challenge 181 s

\* Extrinsic and intrinsic moment of inertia are related by

$$\Theta_{\text{ext}} = \Theta_{\text{int}} + md^2 , \tag{25}$$

where  $d$  is the distance between the centre of mass and the axis of extrinsic rotation. This relation is called *Steiner's parallel axis theorem*. Are you able to deduce it?

Challenge 179 s

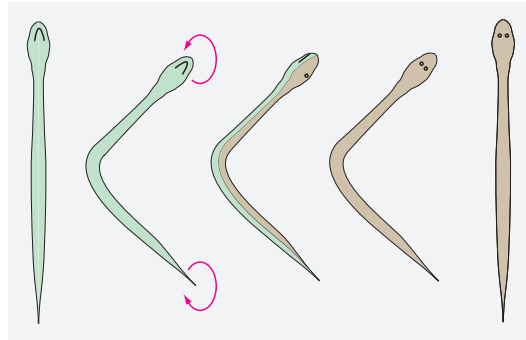


FIGURE 65 How a snake turns itself around its axis.

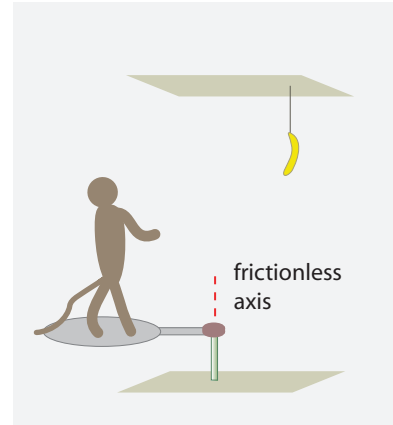


FIGURE 66 Can the ape reach the banana?

would become famous. For undistorted rotated objects, rotational energy is conserved.

Challenge 182 s

Every object that has an orientation also has an intrinsic angular momentum. (What about a sphere?) Therefore, point particles do not have intrinsic angular momenta – at least in first approximation. (This conclusion will change in quantum theory.) The *extrinsic* angular momentum  $\mathbf{L}$  of a point particle is given by

$$\mathbf{L} = \mathbf{r} \times \mathbf{p} = \frac{2\mathbf{a}(T)m}{T} \quad \text{so that} \quad L = r p = \frac{2A(T)m}{T} \quad (27)$$

where  $\mathbf{p}$  is the momentum of the particle,  $\mathbf{a}(T)$  is the surface swept by the position vector  $\mathbf{r}$  of the particle during time  $T$ . The angular momentum thus points along the rotation axis, following the right-hand rule, as shown in Figure 64.

As in the case of linear motion, rotational energy and angular momentum are not always conserved in the macroscopic world: rotational energy can change due to friction, and angular momentum can change due to external forces (torques). However, for closed (undisturbed) systems both quantities are always conserved. In particular, on a microscopic scale, most objects are undisturbed, so that conservation of rotational energy and angular momentum is especially obvious there.

On a frictionless surface, as approximated by smooth ice or by a marble floor covered by a layer of oil, it is impossible to move forward. In order to move, we need to push *against* something. Is this also the case for rotation?

We note that the effects of rotation and many sensors for rotation are the same as for acceleration. But a few sensors for rotation are fundamentally new. In particular, we will meet the gyroscope shortly.

Page 118

Surprisingly, it is possible to turn even *without* pushing against something. You can check this on a well-oiled rotating office chair: simply rotate an arm above the head. After each turn of the hand, the orientation of the chair has changed by a small amount. Indeed, conservation of angular momentum and of rotational energy do not prevent bodies from changing their orientation. Cats learn this in their youth. After they have learned the trick, if they are dropped legs up, they can turn themselves in such a way that they always



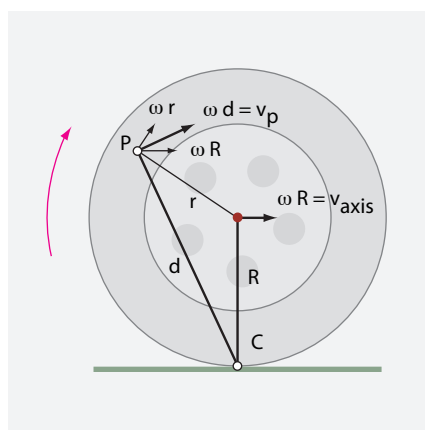


FIGURE 67 The velocities and unit vectors for a rolling wheel.

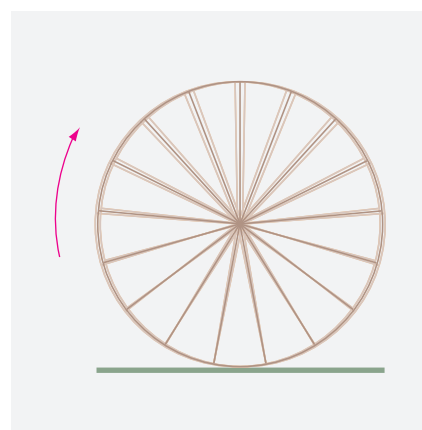


FIGURE 68 A simulated photograph of a rolling wheel with spokes.

- Ref. 82 land feet first. Snakes also know how to rotate themselves, as Figure 65 shows. During the Olympic Games one can watch board divers and gymnasts perform similar tricks. Challenge 183 d Rotation is thus different from translation in this aspect. (Why?)

- Ref. 2 Angular momentum is conserved. This statement is valid for any axis, provided that external forces (torques) play no role. To make the point, Jean-Marc Lévy-Leblond poses the problem of Figure 66. Can the ape reach the banana without leaving the plate, assuming that the plate on which the ape rests can turn around the axis without friction? Challenge 184 s

### ROLLING WHEELS

Rotation is an interesting phenomenon in many ways. A rolling wheel does *not* turn around its axis, but around its point of contact. Let us show this.

A wheel of radius  $R$  is *rolling* if the speed of the axis  $v_{\text{axis}}$  is related to the angular velocity  $\omega$  by

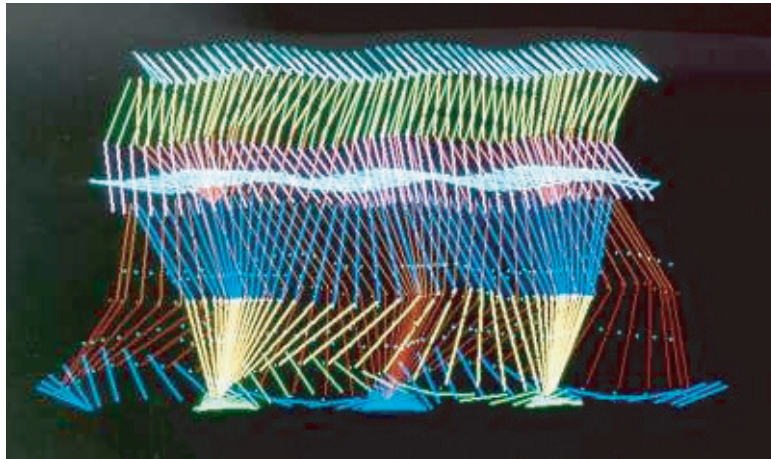
$$\omega = \frac{v_{\text{axis}}}{R} . \tag{28}$$

- Challenge 185 e For any point  $P$  on the wheel, with distance  $r$  from the axis, the velocity  $v_p$  is the sum of the motion of the axis and the motion around the axis. Figure 67 shows that  $v_p$  is orthogonal to  $d$ , the distance between the point  $P$  and the contact point of the wheel. The figure also shows that the length ratio between  $v_p$  and  $d$  is the same as between  $v_{\text{axis}}$  and  $R$ . As a result, we can write

$$\mathbf{v}_p = \boldsymbol{\omega} \times \mathbf{d} , \tag{29}$$

which shows that a rolling wheel does indeed rotate about its point of contact with the ground.

- Challenge 186 s Surprisingly, when a wheel rolls, some points on it move towards the wheel's axis, some stay at a fixed distance and others move away from it. Can you determine where these various points are located? Together, they lead to an interesting pattern when a rolling wheel with spokes, such as a bicycle wheel, is photographed. Ref. 83



**FIGURE 69** The measured motion of a walking human (© Ray McCoy).

Ref. 84 With these results you can tackle the following beautiful challenge. When a turning bicycle wheel is put on a slippery surface, it will slip for a while and then end up rolling.  
Challenge 187 d How does the final speed depend on the initial speed and on the friction?

### HOW DO WE WALK?

“Golf is a good walk spoiled.

”  
Mark Twain

Why do we move our arms when walking or running? To save energy or to be graceful? In fact, whenever a body movement is performed with as little energy as possible, it is natural and graceful. This correspondence can indeed be taken as the actual definition of grace. The connection is common knowledge in the world of dance; it is also a central aspect of the methods used by actors to learn how to move their bodies as beautifully as possible.

Ref. 20

To convince yourself about the energy savings, try walking or running with your arms fixed or moving in the opposite direction to usual: the effort required is considerably higher. In fact, when a leg is moved, it produces a torque around the body axis which has to be counterbalanced. The method using the least energy is the swinging of arms. Since the arms are lighter than the legs, they must move further from the axis of the body, to compensate for the momentum; evolution has therefore moved the attachment of the arms, the shoulders, farther apart than those of the legs, the hips. Animals on two legs but no arms, such as penguins or pigeons, have more difficulty walking; they have to move their whole torso with every step.

Ref. 85

Which muscles do most of the work when walking, the motion that experts call *gait*? In 1980, Serge Gracovetsky found that in human gait a large fraction of the power comes from the muscles along the *spine*, not from those of the legs. (Indeed, people without legs are also able to walk. However, a number of muscles in the legs must work in order to walk normally.) When you take a step, the lumbar muscles straighten the spine; this automatically makes it turn a bit to one side, so that the knee of the leg on that side automatically comes forward. When the foot is moved, the lumbar muscles can relax,

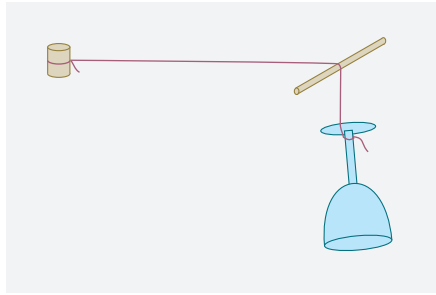


FIGURE 70 Is it safe to let the cork go?

Challenge 188 e

and then straighten again for the next step. In fact, one can experience the increase in tension in the *back* muscles when walking without moving the arms, thus confirming where the human engine is located.

Human legs differ from those of apes in a fundamental aspect: humans are able to run. In fact the whole human body has been optimized for running, an ability that no other primate has. The human body has shed most of its hair to achieve better cooling, has evolved the ability to run while keeping the head stable, has evolved the right length of arms for proper balance when running, and even has a special ligament in the back that works as a shock absorber while running. In other words, running is the most human of all forms of motion.

#### CURIOSITIES AND FUN CHALLENGES ABOUT CONSERVATION

“It is a mathematical fact that the casting of this pebble from my hand alters the centre of gravity of the universe.”

Thomas Carlyle,\* *Sartor Resartus III.*

Ref. 86

Challenge 190 s

Walking is a source of many physics problems. When climbing a mountain, the most energy-effective way is not always to follow the steepest ascent; indeed, for steep slopes, zig-zagging is more energy efficient. Why? And can you estimate the slope angle at which this will happen?

\* \*

Challenge 191 s

A car at a certain speed uses 7 litres of gasoline per 100 km. What is the combined air and rolling resistance? (Assume that the engine has an efficiency of 25%.)

\* \*

Challenge 192 s

A cork is attached to a thin string a metre long. The string is passed over a long rod held horizontally, and a wine glass is attached at the other end. If you let go the cork in Figure 70, nothing breaks. Why not? And what happens?

\* \*

In 1907, Duncan MacDougalls, a medical doctor, measured the weight of dying people,

Challenge 189 s

\* Thomas Carlyle (1797–1881), Scottish essayist. Do you agree with the quotation?

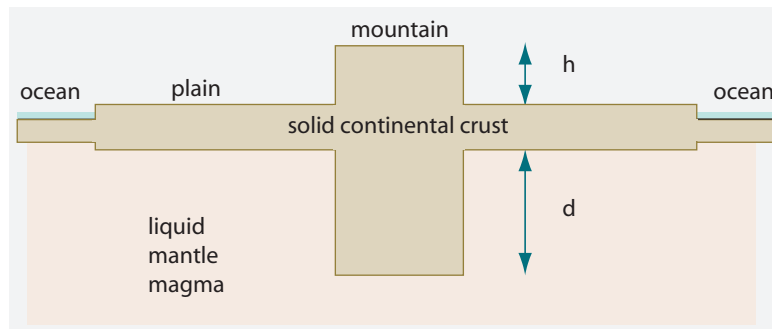


FIGURE 71 A simple model for continents and mountains.

- Ref. 87 in the hope to see whether death leads to a mass change. He found a sudden decrease between 10 and 20 g at the moment of death. He attributed it to the soul exiting the body.  
 Challenge 193 s Can you find a more satisfying explanation?

\* \*

It is well known that the weight of a one-year old child depends on whether the it wants to be carried or whether it wants to reach the floor. Does this contradict mass conservation?

Challenge 194 e

\* \*

- Challenge 195 s The Earth's crust is less dense (2.7 kg/l) than the Earth's mantle (3.1 kg/l) and floats on it. As a result, the lighter crust below a mountain ridge must be much deeper than below a plain. If a mountain rises 1 km above the plain, how much deeper must the crust be below it? The simple block model shown in Figure 71 works fairly well; first, it explains why, near mountains, measurements of the deviation of free fall from the vertical line lead to so much lower values than those expected without a deep crust. Later, sound measurements have confirmed directly that the continental crust is indeed thicker beneath mountains.

\* \*

- Challenge 196 e All homogeneous cylinders roll down an inclined plane in the same way. True or false? And what about spheres? Can you show that spheres roll faster than cylinders?

\* \*

- Challenge 197 e Take a pile of coins. One can push out the coins, starting with the one at the bottom, by shooting another coin over the table surface. The method also helps to visualize two-dimensional momentum conservation.

\* \*

- Ref. 88 In early 2004, two men and a woman earned £1.2 million in a single evening in a London casino. They did so by applying the formulae of Galilean mechanics. They used the method pioneered by various physicists in the 1950s who built various small computers that could predict the outcome of a roulette ball from the initial velocity imparted by the croupier. In the case in Britain, the group added a laser scanner to a smart phone that measured the path of a roulette ball and predicted the numbers where it would arrive.

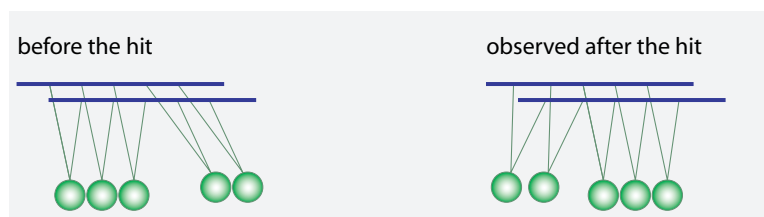


FIGURE 72 A well-known toy.



FIGURE 73 An elastic collision that seems not to obey energy conservation.

In this way, they increased the odds from 1 in 37 to about 1 in 6. After six months of investigations, Scotland Yard ruled that they could keep the money they won.

In fact around the same time, a few people earned around 400 000 euro over a few weeks by using the same method in Germany, but with no computer at all. In certain casinos, machines were throwing the roulette ball. By measuring the position of the zero to the incoming ball with the naked eye, these gamblers were able to increase the odds of the bets they placed during the last allowed seconds and thus win a considerable sum purely through fast reactions.

\* \*

The toy of Figure 72 shows interesting behaviour: when a number of spheres are lifted and dropped to hit the resting ones, the same number of spheres detach on the other side, whereas the previously dropped spheres remain motionless. At first sight, all this seems to follow from energy and momentum conservation. However, energy and momentum conservation provide only two equations, which are insufficient to explain or determine the behaviour of five spheres. Why then do the spheres behave in this way? And why do they all swing in phase when a longer time has passed?

Challenge 198 d

\* \*

A surprising effect is used in home tools such as hammer drills. We remember that when a small ball elastically hits a large one at rest, both balls move after the hit, and the small one obviously moves faster than the large one. Despite this result, when a short cylinder hits a long one of the same diameter and material, but with a length that is some integer multiple of that of the short one, something strange happens. After the hit, the small cylinder remains almost at rest, whereas the large one moves, as shown in Figure 73. Even though the collision is elastic, conservation of energy seems not to hold in this case. (In fact this is the reason that demonstrations of elastic collisions in schools are always performed with spheres.) What happens to the energy?

Ref. 89

Challenge 199 d

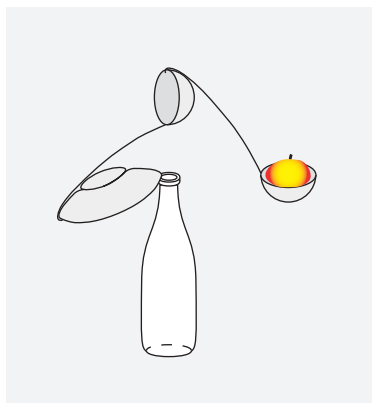


FIGURE 74 The centre of mass defines stability.

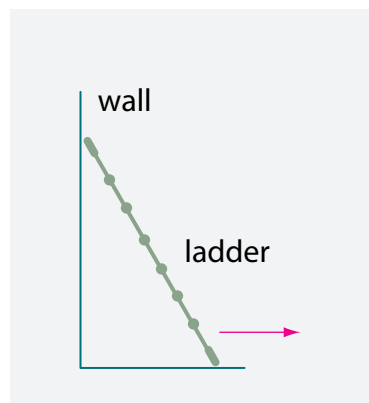


FIGURE 75 How does the ladder fall?

\* \*

Challenge 200 s Does a wall get a stronger jolt when it is hit by a ball rebounding from it or when it is hit by a ball that remains stuck to it?

\* \*

Challenge 201 s Housewives know how to extract a cork of a wine bottle using a cloth. Can you imagine how? They also know how to extract the cork with the cloth if the cork has fallen inside the bottle. How?

\* \*

Challenge 202 ny The sliding ladder problem, shown schematically in Figure 75, asks for the detailed motion of the ladder over time. The problem is more difficult than it looks, even if friction is not taken into account. Can you say whether the lower end always touches the floor?

\* \*

A homogeneous ladder of length 5 m and mass 30 kg leans on a wall. The angle is  $30^\circ$ ; the static friction coefficient on the wall is negligible, and on the floor it is 0.3. A person of mass 60 kg climbs the ladder. What is the maximum height the person can climb before the ladder starts sliding? This and many puzzles about ladders can be found on [www.mathematische-basteleien.de/leiter.htm](http://www.mathematische-basteleien.de/leiter.htm).

\* \*

Ref. 90 Challenge 203 s A common fly on the stern of a 30 000 ton ship of 100 m length tilts it by less than the diameter of an atom. Today, distances that small are easily measured. Can you think of at least two methods, one of which should not cost more than 2000 euro?

\* \*

Challenge 204 ny Is the image of three stacked spinning tops shown in Figure 76 a true photograph, showing a real observation, or is it the result of digital composition, showing an impossible situation?



**FIGURE 76** Is this a possible situation or is it a fake photograph?  
(© Wikimedia)

\* \*

**Challenge 205 s** How does the kinetic energy of a rifle bullet compare to that of a running man?

\* \*

**Challenge 206 s** What happens to the size of an egg when one places it in a jar of vinegar for a few days?

\* \*

**Challenge 207 s** What is the amplitude of a pendulum oscillating in such a way that the absolute value of its acceleration at the lowest point and at the return point are equal?

\* \*

**Challenge 208 d** Can you confirm that the value of the acceleration of a drop of water falling through vapour is  $g/7$ ?

\* \*

**Challenge 209 ny** You have two hollow spheres: they have the same weight, the same size and are painted in the same colour. One is made of copper, the other of aluminium. Obviously, they fall with the same speed and acceleration. What happens if they both roll down a tilted plane?

\* \*

**Challenge 210 ny** What is the shape of a rope when rope jumping?

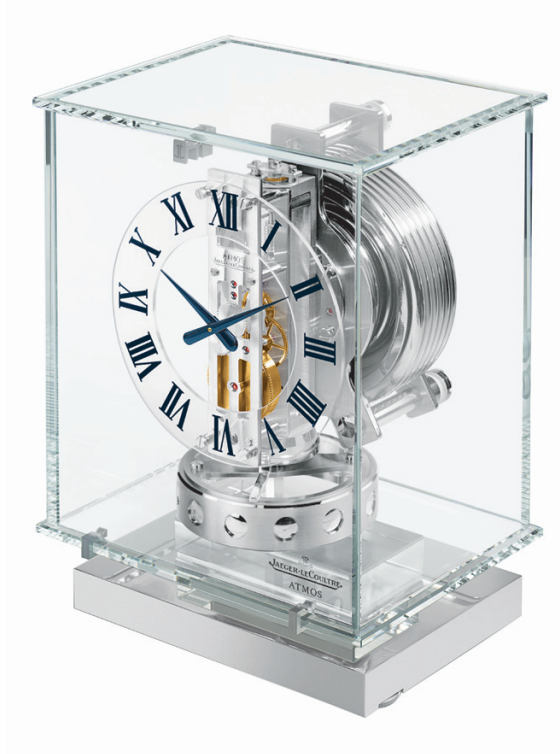
\* \*

**Challenge 211 s** How can you determine the speed of a rifle bullet with only a scale and a metre stick?

\* \*

**Challenge 212 e** Why does a gun make a hole in a door but cannot push it open, in exact contrast to what a finger can do?





**FIGURE 77** A commercial clock that needs no special energy source, because it takes its energy from the environment (© Jaeger-LeCoultre).

\* \*

**Challenge 213 s** What is the curve described by the midpoint of a ladder sliding down a wall?

\* \*

**Challenge 214 s** A high-tech company, see [www.enocean.com](http://www.enocean.com), sells electric switches for room lights that have no cables and no power cell (battery). You can glue such a switch to the centre of a window pane. How is this possible?

\* \*

**Challenge 215 s** For over 50 years, a famous Swiss clock maker is selling table clocks with a rotating pendulum that need no battery and no manual rewinding, as they take up energy from the environment. A specimen is shown in [Figure 77](#). Can you imagine how this clock works?

\* \*

All masses are measured by comparing them, directly or indirectly, to the *standard kilogram* in Sèvres near Paris. Since a few years, there is the serious doubt that the standard kilogram is losing weight, possibly through outgassing, with an estimated rate of around  $0.5 \mu\text{g/a}$ . This is an awkward situation, and there is a vast, world-wide effort to find a better definition of the kilogram. Such an improved definition must be simple, precise, and

avoid trips to Sèvres. No such alternative has been defined yet.

\* \*

Which engine is more efficient: a moped or a human on a bicycle?

\* \*

Both mass and moment of inertia can be defined and measured both with and without contact. Can you do so?

Challenge 216 e

### SUMMARY ON CONSERVATION

“The gods are not as rich as one might think:  
what they give to one, they take away from the  
other.”

Antiquity

We have encountered four conservation principles that are valid for closed systems in everyday life:

- conservation of total linear momentum,
- conservation of total angular momentum,
- conservation of total energy,
- conservation of total mass.

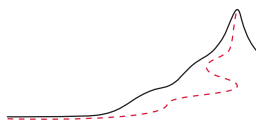
Later on, the theory of special relativity will show that the last two quantities are conserved only when taken together. None of these conservation laws applies to motion of images.

These conservation principles are among the great results in science. They limit the surprises that nature can offer: conservation means that linear momentum, angular momentum, and mass–energy can neither be created from nothing, nor can they disappear into nothing. Conservation limits creation. The above quote, almost blasphemous, expresses this idea.

Page 227

Later on we will find out that these results could have been deduced from three simple observations: closed systems behave the same independently of where they are, in what direction they are oriented and of the time at which they are set up. Motion is universal. In more abstract and somewhat more general terms, physicists like to say that all conservation principles are consequences of the *invariances*, or *symmetries*, of nature.





## CHAPTER 5

# FROM THE ROTATION OF THE EARTH TO THE RELATIVITY OF MOTION

“Eppur si muove!”

Anonymous\*

Ref. 91

Is the Earth rotating? The search for answers to this question gives a beautiful cross section of the history of classical physics. Around the year 265 BCE, the Greek thinker Aristarchus of Samos maintained that the Earth rotates. He had measured the parallax of the Moon (today known to be up to  $0.95^\circ$ ) and of the Sun (today known to be  $8.8'$ ).\*\* The *parallax* is an interesting effect; it is the angle describing the difference between the directions of a body in the sky when seen by an observer on the surface of the Earth and when seen by a hypothetical observer at the Earth's centre. (See Figure 78.) Aristarchus noticed that the Moon and the Sun *wobble* across the sky, and this wobble has a period of 24 hours. He concluded that the Earth rotates.

Vol. II, page 16

Measurements of the aberration of light also show the rotation of the Earth; it can be detected with a telescope while looking at the stars. The *aberration* is a change of the expected light direction, which we will discuss shortly. At the Equator, Earth rotation adds an angular deviation of  $0.32'$ , changing sign every 12 hours, to the aberration due to the motion of the Earth around the Sun, about  $20.5'$ . In modern times, astronomers have found a number of additional proofs, but none is accessible to the man on the street.

Furthermore, the measurements showing that the Earth is not a sphere, but is *flattened* at the poles, confirmed the rotation of the Earth. Again, however, this eighteenth century measurement by Maupertuis\*\*\* is not accessible to everyday observation.

Then, in the years 1790 to 1792 in Bologna, Giovanni Battista Guglielmini (1763–1817) finally succeeded in measuring what Galileo and Newton had predicted to be the simplest proof for the Earth's rotation. On the Earth, objects do not fall vertically, but are slightly deviated to the east. This deviation appears because an object keeps the larger

---

\* 'And yet she moves' is the sentence about the Earth attributed, most probably incorrectly, to Galileo since the 1640s. It is true, however, that at his trial he was forced to publicly retract the statement of a moving Earth to save his life. For more details, see the section on page 265.

\*\* For the definition of angles see page 61, and for the definition of angle units see Appendix B.

\*\*\* Pierre Louis Moreau de Maupertuis (1698–1759), French physicist and mathematician. He was one of the key figures in the quest for the principle of least action, which he named in this way. He was also founding president of the Berlin Academy of Sciences. Maupertuis thought that the principle reflected the maximization of goodness in the universe. This idea was thoroughly ridiculed by Voltaire in his *Histoire du Docteur Akakia et du natif de Saint-Malo*, 1753. Maupertuis ([www.voltaire-integral.com/Html/23/08DIAL.htm](http://www.voltaire-integral.com/Html/23/08DIAL.htm)) performed his measurement of the Earth to distinguish between the theory of gravitation of Newton and that of Descartes, who had predicted that the Earth is elongated at the poles, instead of flattened.

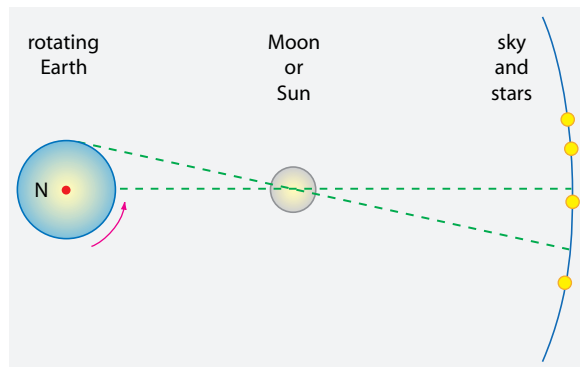


FIGURE 78 The parallax – not drawn to scale.

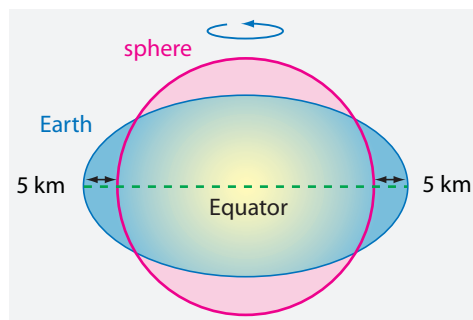


FIGURE 79 Earth's deviation from spherical shape due to its rotation (exaggerated).

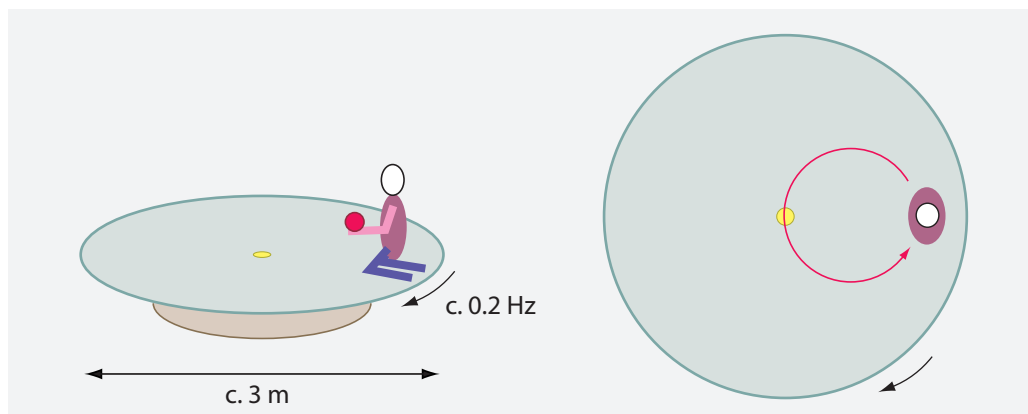


FIGURE 80 A typical carousel allows observing the Coriolis effect in its most striking appearance: if a person lets a ball roll with the proper speed and direction, the ball is deflected so strongly that it comes back to her.

horizontal velocity it had at the height from which it started falling, as shown in Figure 81. Guglielmini's result was the first non-astronomical proof of the Earth's rotation. The experiments were repeated in 1802 by Johann Friedrich Benzenberg (1777–1846). Using metal balls which he dropped from the Michaelis tower in Hamburg – a height of 76 m – Benzenberg found that the deviation to the east was 9.6 mm. Can you confirm that the value measured by Benzenberg almost agrees with the assumption that the Earth turns

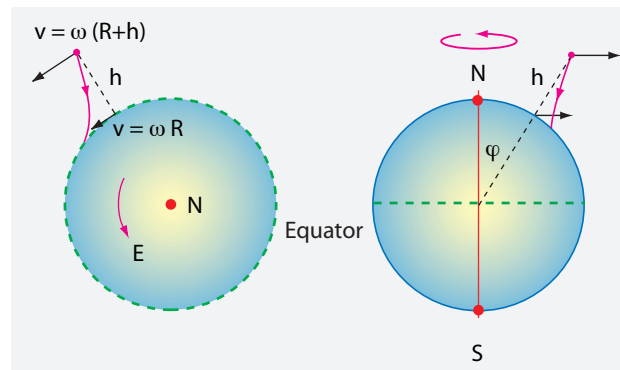


FIGURE 81 The deviations of free fall towards the east and towards the Equator due to the rotation of the Earth.

Challenge 217 ny

Page 157

Ref. 92

Challenge 218 s

Ref. 93

once every 24 hours? (There is also a much smaller deviation towards the Equator, not measured by Guglielmini, Benzenberg or anybody after them up to this day; however, it completes the list of effects on free fall by the rotation of the Earth.) Both deviations are easily understood if we use the result (described below) that falling objects describe an ellipse around the centre of the rotating Earth. The elliptical shape shows that the path of a thrown stone does not lie on a plane for an observer standing on Earth; for such an observer, the exact path thus cannot be drawn on a piece of paper.

In 1835, Gustave-Gaspard Coriolis discovered a closely related effect that nobody had as yet noticed in everyday life. Imagine a ball that rolls over a table. For a person on the floor, the ball rolls in a straight line. Now imagine that the table rotates. For the person on the floor, the ball still rolls in a straight line. But for a person on the rotating table, the ball traces a *curved* path. In short, any object that travels in a rotating background is subject to a transversal acceleration. This is the so-called *Coriolis acceleration* or Coriolis effect. On a rotating background, travelling objects deviate from the straight line. The best way to understand the Coriolis effect is to experience it yourself; this can be done on a carousel, as shown in Figure 80. Watching for videos on the internet is also helpful. Said simply, on a rotating carousel it is not easy to hit a target by throwing or rolling a ball.

Now, the Earth is a rotating background. On the northern hemisphere, the rotation is anticlockwise. As the result, any moving object is slightly deviated to the right (while the magnitude of its velocity stays constant). On Earth, like on all rotating backgrounds, the *Coriolis acceleration*  $\mathbf{a}$  results from the change of distance to the rotation axis. Can you deduce the analytical expression for it, namely  $\mathbf{a}_C = -2\boldsymbol{\omega} \times \mathbf{v}$ ?

On Earth, the Coriolis acceleration generally has a small value. Therefore it is best observed either in large-scale or high-speed phenomena. Indeed, the Coriolis acceleration determines the handedness of many large-scale phenomena with a spiral shape, such as the directions of cyclones and anticyclones in meteorology, the general wind patterns on Earth and the deflection of ocean currents and tides. These phenomena have opposite handedness on the northern and the southern hemisphere. Most beautifully, the Coriolis acceleration explains why icebergs do not follow the direction of the wind as they drift away from the polar caps. The Coriolis acceleration also plays a role in the flight of cannon balls (that was the original interest of Coriolis), in satellite launches, in the

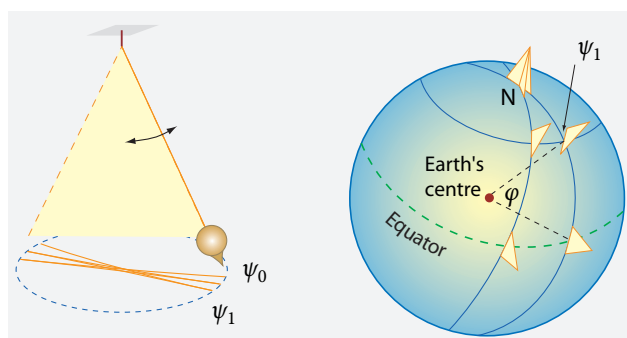


FIGURE 82 The turning motion of a pendulum showing the rotation of the Earth.

Ref. 94 motion of sunspots and even in the motion of electrons in molecules. All these Coriolis accelerations are of opposite sign on the northern and southern hemispheres and thus prove the rotation of the Earth. (In the First World War, many naval guns missed their targets in the southern hemisphere because the engineers had compensated them for the Coriolis effect in the northern hemisphere.)

Ref. 95 Only in 1962, after several earlier attempts by other researchers, Asher Shapiro was the first to verify that the Coriolis effect has a tiny influence on the direction of the vortex formed by the water flowing out of a bathtub. Instead of a normal bathtub, he had to use a carefully designed experimental set-up because, contrary to an often-heard assertion, no such effect can be seen in a real bathtub. He succeeded only by carefully eliminating all disturbances from the system; for example, he waited 24 hours after the filling of the reservoir (and never actually stepped in or out of it!) in order to avoid any left-over motion of water that would disturb the effect, and built a carefully designed, completely rotationally-symmetric opening mechanism. Others have repeated the experiment in the southern hemisphere, finding opposite rotation direction and thus confirming the result. In other words, the handedness of usual bathtub vortices is *not* caused by the rotation of the Earth, but results from the way the water starts to flow out. But let us go on with the story about the Earth's rotation.

In 1851, the French physician-turned-physicist Jean Bernard Léon Foucault (b. 1819 Paris, d. 1868 Paris) performed an experiment that removed all doubts and rendered him world-famous practically overnight. He suspended a 67 m long pendulum\* in the Panthéon in Paris and showed the astonished public that the direction of its swing changed over time, rotating slowly. To anybody with a few minutes of patience to watch the change of direction, the experiment proved that the Earth rotates. If the Earth did not rotate, the swing of the pendulum would always continue in the same direction. On a rotating Earth, in Paris, the direction changes to the right, in clockwise sense, as shown in Figure 82. The direction does not change if the pendulum is located at the Equator, and it changes to the left in the southern hemisphere.\*\* A modern version of the pendulum can be observed via the web cam at [pendelcam.kip.uni-heidelberg.de/](http://pendelcam.kip.uni-heidelberg.de/);

Challenge 219 d

Ref. 96

\* Why was such a long pendulum necessary? Understanding the reasons allows one to repeat the experiment at home, using a pendulum as short as 70 cm, with the help of a few tricks. To observe the effect with a simple set-up, attach a pendulum to your office chair and rotate the chair slowly.

\*\* The discovery also shows how precision and genius go together. In fact, the first person to observe the effect was Vincenzo Viviani, a student of Galileo, as early as 1661! Indeed, Foucault had read about Viviani's

high speed films of the pendulum's motion during day and night can be downloaded at [www.kip.uni-heidelberg.de/OeffWiss/Pendel-Internetauftritt/zeitraffer.php](http://www.kip.uni-heidelberg.de/OeffWiss/Pendel-Internetauftritt/zeitraffer.php). (Several pendulum animations, with exaggerated deviation, can be found at [commons.wikimedia.org/wiki/Foucault\\_pendulum](https://commons.wikimedia.org/wiki/Foucault_pendulum)).

The time over which the orientation of the pendulum's swing performs a full turn – the *precession time* – can be calculated. Study a pendulum starting to swing in the North–South direction and you will find that the precession time  $T_{\text{Foucault}}$  is given by

$$T_{\text{Foucault}} = \frac{23 \text{ h } 56 \text{ min}}{\sin \varphi} \quad (30)$$

where  $\varphi$  is the latitude of the location of the pendulum, e.g.  $0^\circ$  at the Equator and  $90^\circ$  at the North Pole. This formula is one of the most beautiful results of Galilean kinematics.\*

Foucault was also the inventor and namer of the *gyroscope*. He built the device, shown in [Figure 83](#), in 1852, one year after his pendulum. With it, he again demonstrated the rotation of the Earth. Once a gyroscope rotates, the axis stays fixed in space – but only when seen from distant stars or galaxies. (This is not the same as talking about absolute space. Why?) For an observer on Earth, the axis direction changes regularly with a period of 24 hours. Gyroscopes are now routinely used in ships and in aeroplanes to give the direction of north, because they are more precise and more reliable than magnetic compasses. In the most modern versions, one uses laser light running in circles instead of rotating masses.\*\*

In 1909, Roland von Eötvös measured a simple effect: due to the rotation of the Earth, the weight of an object depends on the direction in which it moves. As a result, a balance in rotation around the vertical axis does not stay perfectly horizontal: the balance starts to oscillate slightly. Can you explain the origin of the effect?

In 1910, John Hagen published the results of an even simpler experiment, proposed by Louis Poinsoit in 1851. Two masses are put on a horizontal bar that can turn around a vertical axis, a so-called *isotomeograph*. If the two masses are slowly moved towards the support, as shown in [Figure 84](#), and if the friction is kept low enough, the bar rotates. Obviously, this would not happen if the Earth were not rotating. Can you explain the observation? This little-known effect is also useful for winning bets between physicists.

In 1913, Arthur Compton showed that a closed tube filled with water and some small floating particles (or bubbles) can be used to show the rotation of the Earth. The device is called a *Compton tube* or *Compton wheel*. Compton showed that when a horizontal tube filled with water is rotated by  $180^\circ$ , something happens that allows one to prove that the Earth rotates. The experiment, shown in [Figure 85](#), even allows measurement of the latitude of the point where the experiment is made. Can you guess what happens?

Another method to detect the rotation of the Earth using light was first realized in 1913 by the French physicist Georges Sagnac:\*\*\* he used an *interferometer* to produce bright

---

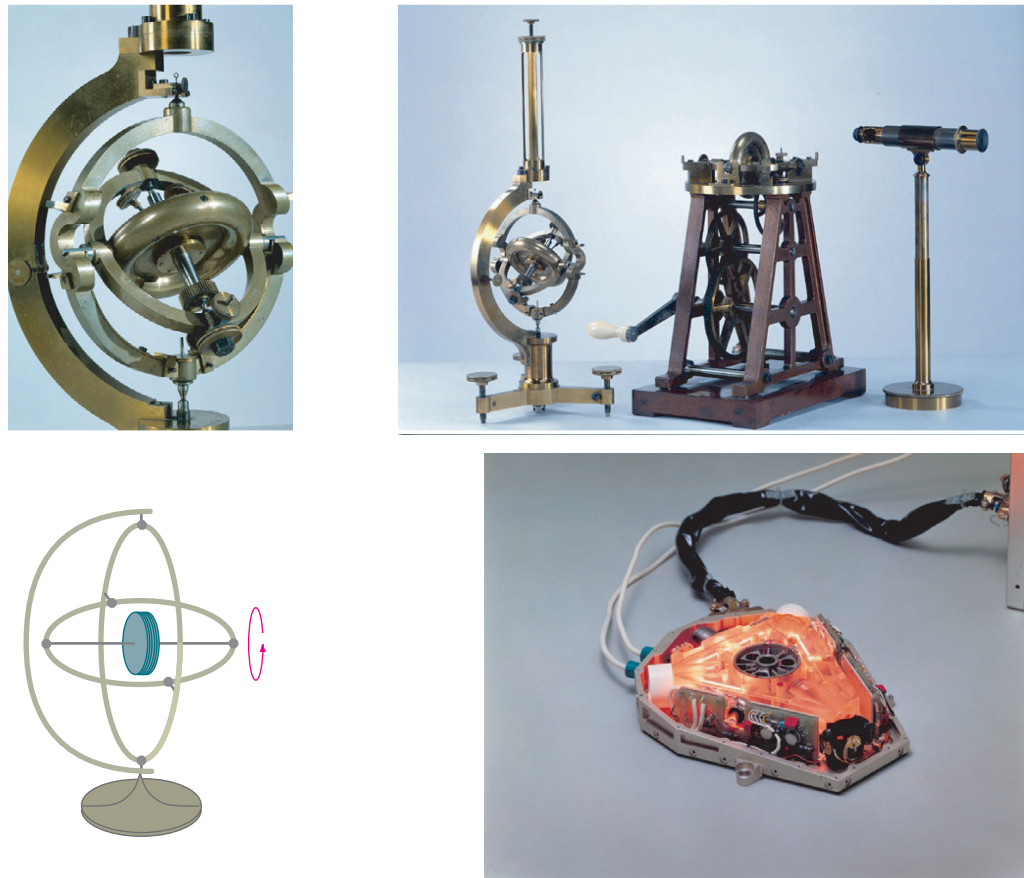
work in the publications of the Academia dei Lincei. But it took Foucault's genius to connect the effect to the rotation of the Earth; nobody had done so before him.

\* The calculation of the period of Foucault's pendulum assumes that the precession rate is constant during a rotation. This is only an approximation (though usually a good one).

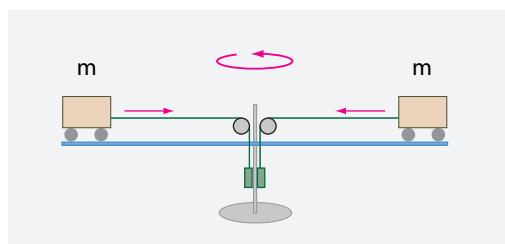
\*\* Can you guess how rotation is detected in this case?

\*\*\* Georges Sagnac (1869–1928) was a physicist in Lille and Paris, friend of the Curies, Langevin, Perrin,

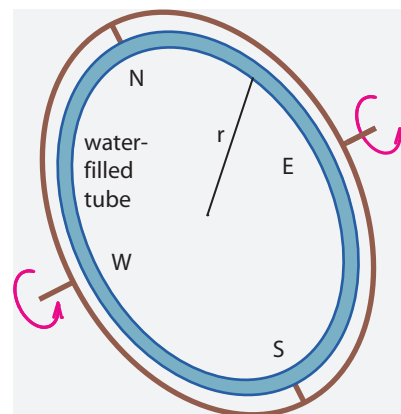




**FIGURE 83** The gyroscope: the original system by Foucault with its freely movable spinning top, the mechanical device to bring it to speed, the optical device to detect its motion, the general construction principle, and a modern (triangular) ring laser gyroscope, based on colour change of rotating laser light instead of angular changes of a rotating mass (© CNAM, JAXA).



**FIGURE 84** Showing the rotation of the Earth through the rotation of an axis.



**FIGURE 85** Demonstrating the rotation of the Earth with water.

and Borel. Sagnac also deduced from his experiment that the speed of light was independent from the speed of its source, and thus confirmed a prediction of special relativity.

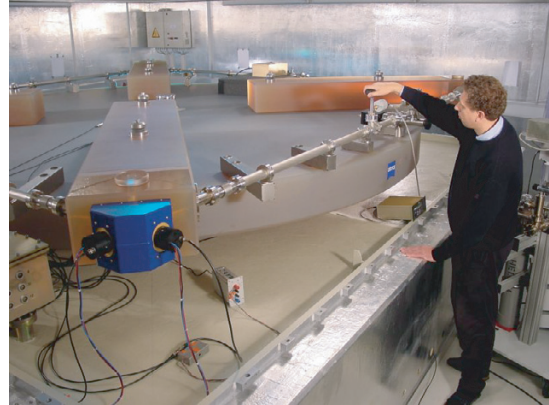
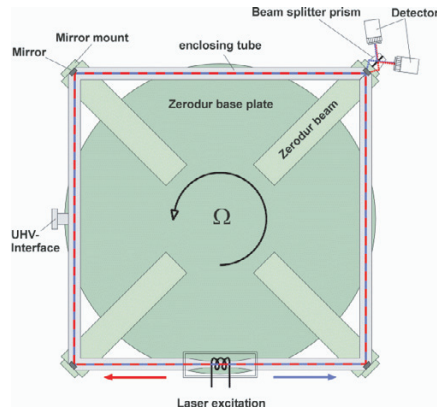


FIGURE 86 A modern precision ring laser interferometer (© Bundesamt für Kartographie und Geodäsie, Carl Zeiss).

Vol. IV, page 48

and dark fringes of light with two light beams, one circulating in clockwise direction, and the second circulating in anticlockwise direction. The interference fringes are *shifted* when the whole system rotates; the faster it rotates, the larger is the shift. A modern, high-precision version of the experiment, which uses lasers instead of lamps, is shown in Figure 86. Sagnac also determined the relation between the fringe shift and the details of the experiment. The rotation of a complete ring interferometer with angular frequency (vector)  $\Omega$  produces a fringe shift of angular phase  $\Delta\varphi$  given by

Challenge 226 s

$$\Delta\varphi = \frac{8\pi \Omega a}{c \lambda} \quad (31)$$

where  $a$  is the area (vector) enclosed by the two interfering light rays,  $\lambda$  their wavelength and  $c$  the speed of light. The effect is now called the *Sagnac effect* after its discoverer. It had already been predicted 20 years earlier by Oliver Lodge.\* Today, Sagnac interferometers are the central part of laser gyroscopes – shown in Figure 83 – and are found in every passenger aeroplane, missile and submarine, in order to measure the changes of their motion and thus to determine their actual position.

Ref. 99

A part of the fringe shift is due to the rotation of the Earth. Modern high-precision Sagnac interferometers use ring lasers with areas of a few square metres; they are able to measure variations of the rotation rates of the Earth of less than one part per million. Indeed, over the course of a year, the length of a day varies irregularly by a few milliseconds, mostly due to influences from the Sun or the Moon, due to weather changes and due to hot magma flows deep inside the Earth.\*\* But also earthquakes, the El Niño effect in the climate and the filling of large water dams have effects on the rotation of the Earth.

Ref. 100

\* Oliver Lodge (1851–1940) was a British physicist who studied electromagnetic waves and tried to communicate with the dead. A strange but influential figure, his ideas are often cited when fun needs to be made of physicists; for example, he was one of those (rare) physicists who believed that at the end of the nineteenth century physics was complete.

\*\* The growth of leaves on trees and the consequent change in the Earth's moment of inertia, already thought of in 1916 by Harold Jeffreys, is way too small to be seen, as it is hidden by larger effects.

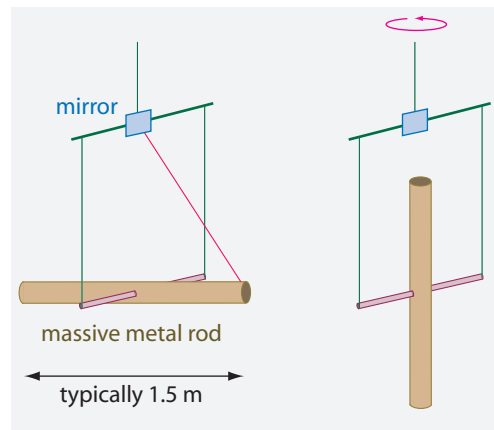


FIGURE 87 Observing the rotation of the Earth in two seconds.

All these effects can be studied with such high-precision interferometers; they can also be used for research into the motion of the soil due to lunar tides or earthquakes, and for checks on the theory of special relativity.

Ref. 101

Challenge 227 s

In 1948, Hans Bucka developed the simplest experiment so far to show the rotation of the Earth. A metal rod allows one to detect the rotation of the Earth after only a few seconds of observation. The experiment can be easily performed in class. Can you guess how it works?

In summary, observations show that the Earth surface rotates at 463 m/s at the Equator, a larger value than that of the speed of sound in air – about 340 m/s in usual conditions – and that we are in fact *whirling* through the universe.

### HOW DOES THE EARTH ROTATE?

Ref. 102

Is the rotation of the Earth *constant* over geological time scales? That is a hard question. If you find a method leading to an answer, publish it! (The same is true for the question whether the length of the year is constant.) Only a few methods are known, as we will find out shortly.

Ref. 103

The rotation of the Earth is not even constant during a human lifespan. It varies by a few parts in  $10^8$ . In particular, on a ‘secular’ time scale, the length of the day increases by about 1 to 2 ms per century, mainly because of the friction by the Moon and the melting of the polar ice caps. This was deduced by studying historical astronomical observations of the ancient Babylonian and Arab astronomers. Additional ‘decadic’ changes have an amplitude of 4 or 5 ms and are due to the motion of the liquid part of the Earth’s core.

The seasonal and biannual changes of the length of the day – with an amplitude of 0.4 ms over six months, another 0.5 ms over the year, and 0.08 ms over 24 to 26 months – are mainly due to the effects of the *atmosphere*. In the 1950s the availability of precision measurements showed that there is even a 14 and 28 day period with an amplitude of 0.2 ms, due to the Moon. In the 1970s, when *wind oscillations* with a length scale of about 50 days were discovered, they were also found to alter the length of the day, with an amplitude of about 0.25 ms. However, these last variations are quite irregular.

Also the oceans influence the rotation of the Earth, due to the tides, the ocean currents,

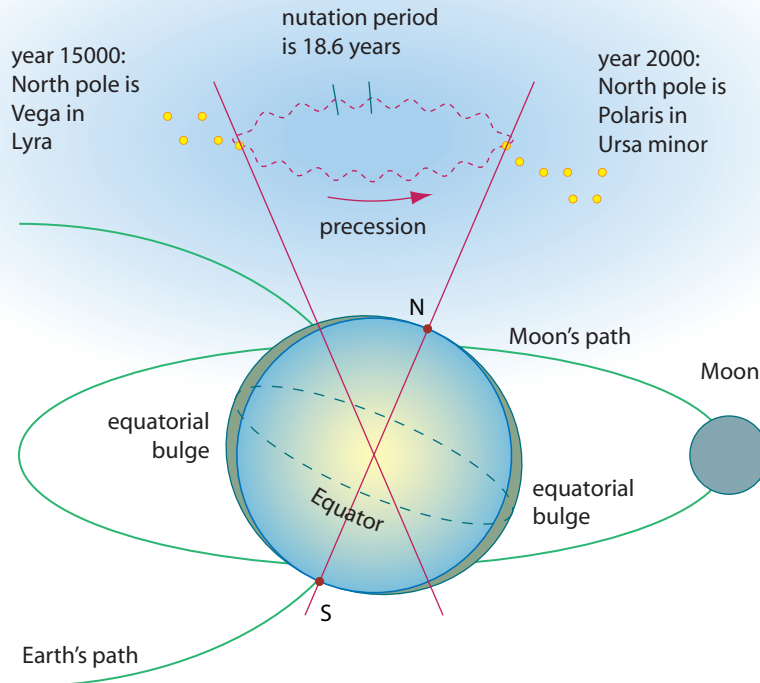


FIGURE 88 The precession and the nutation of the Earth's axis.

Ref. 104 wind forcing, and atmospheric pressure forcing. Further effects are due to the ice sheet variations and due to water evaporation and rain falls. Last but not least, flows in the interior of the Earth, both in the mantle and in the core, change the rotation. For example, earthquakes, plate motion, post-glacial rebound and volcanic eruptions all influence the rotation.

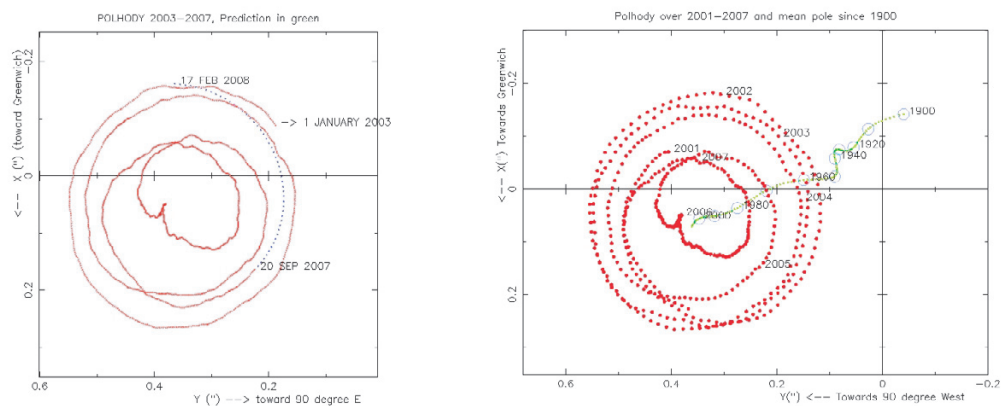
But why does the Earth rotate at all? The rotation derives from the rotating gas cloud at the origin of the solar system. This connection explains that the Sun and all planets, except one, turn around themselves in the same direction, and that they also all turn around the Sun in that same direction. But the complete story is outside the scope of this text.

Ref. 105

The rotation around its axis is not the only motion of the Earth; it performs other motions as well. This was already known long ago. In 128 BCE, the Greek astronomer Hipparchos discovered what is today called the (*equinoctial*) *precession*. He compared a measurement he made himself with another made 169 years before. Hipparchos found that the Earth's axis points to different stars at different times. He concluded that the sky was moving. Today we prefer to say that the axis of the Earth is moving. During a period of 25 800 years the axis draws a cone with an opening angle of  $23.5^\circ$ . This motion, shown in Figure 88, is generated by the tidal forces of the Moon and the Sun on the equatorial bulge of the Earth that results from its flattening. The Sun and the Moon try to align the



**FIGURE 89**  
Precession of a suspended spinning top (mpg film © Lucas V. Barbosa)

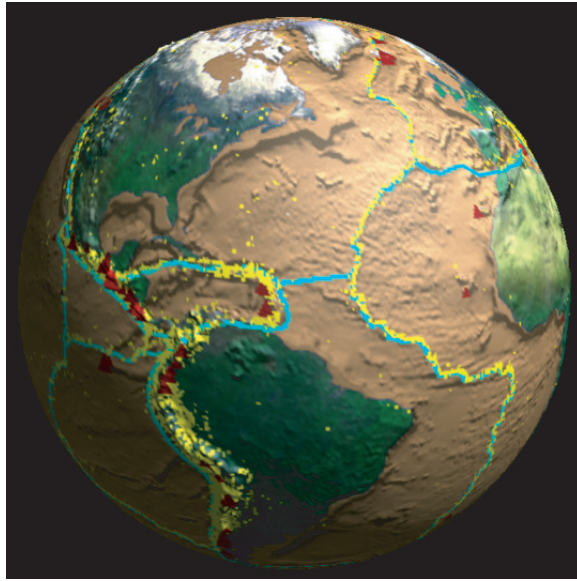


**FIGURE 90** The motion of the North Pole from 2003 to 2007, including the prediction until 2008 (left) and the average position since 1900 (right) – with 0.1 arcsecond being around 3.1 m on the surface of the Earth – not showing the diurnal and semidiurnal variations of a fraction of a millisecond of arc due to the tides (from [hpiers.obspm.fr/eop-pc](http://hpiers.obspm.fr/eop-pc)).

axis of the Earth at right angles to the Earth's path; this torque leads to the precession of the Earth's axis.

Precession is a motion common to all rotating systems: it appears in planets, spinning tops and atoms. (Precession is also at the basis of the surprise related to the suspended wheel shown on [page 196](#).) Precession is most easily seen in spinning tops, be they suspended or not. An example is shown in [Figure 89](#); for atomic nuclei or planets, just imagine that the suspending wire is missing and the rotating body less flat.





**FIGURE 91** The continental plates are the objects of tectonic motion.

In addition, the axis of the Earth is not even fixed relative to the Earth's surface. In 1884, by measuring the exact angle above the horizon of the celestial North Pole, Friedrich Küstner (1856–1936) found that the axis of the Earth *moves* with respect to the Earth's crust, as Bessel had suggested 40 years earlier. As a consequence of Küstner's discovery, the International Latitude Service was created. The *polar motion* Küstner discovered turned out to consist of three components: a small linear drift – not yet understood – a yearly elliptical motion due to seasonal changes of the air and water masses, and a circular motion\* with a period of about 1.2 years due to fluctuations in the pressure at the bottom of the oceans. In practice, the North Pole moves with an amplitude of about 15 m around an average central position, as shown in Figure 90. Short term variations of the North Pole position, due to local variations in atmospheric pressure, to weather change and to the tides, have also been measured. Only with help of the exact position of the Earth's axis is the high precision of the GPS system possible; and only with this knowledge can artificial satellites be guided to Mars or other planets.

Ref. 106

Ref. 107

In 1912, the German meteorologist and geophysicist Alfred Wegener (1880–1930) discovered an even larger effect. After studying the shapes of the continental shelves and the geological layers on both sides of the Atlantic, he conjectured that the continents *move*, and that they are all fragments of a single continent that broke up 200 million years ago.\*\*

Even though at first derided across the world, Wegener's discoveries were correct. Modern satellite measurements, shown in Figure 91, confirm this model. For example,

\* The circular motion, a wobble, was predicted by the great Swiss mathematician Leonhard Euler (1707–1783). In an incredible story, using Euler's and Bessel's predictions and Küstner's data, in 1891 Seth Chandler claimed to be the discoverer of the circular component.

\*\* In this old continent, called Gondwanaland, there was a huge river that flowed westwards from the Chad to Guayaquil in Ecuador. After the continent split up, this river still flowed to the west. When the Andes appeared, the water was blocked, and many millions of years later, it flowed back. Today, the river still flows eastwards and is called the Amazon River.



FIGURE 92 Friedrich Wilhelm Bessel (1784–1846).

the American continent moves away from the European continent by about 10 mm every year. There are also speculations that this velocity may have been much higher at certain periods in the past. The way to check this is to look at the magnetization of sedimental rocks. At present, this is still a hot topic of research. Following the modern version of the model, called *plate tectonics*, the continents (with a density of  $2.7 \cdot 10^3 \text{ kg/m}^3$ ) float on the fluid mantle of the Earth (with a density of  $3.1 \cdot 10^3 \text{ kg/m}^3$ ) like pieces of cork on water, and the convection inside the mantle provides the driving mechanism for the motion.

Page 108, page 152

Ref. 108

### DOES THE EARTH MOVE?

The centre of the Earth is not at rest in the universe. In the third century BCE Aristarchus of Samos maintained that the Earth turns around the Sun. However, a fundamental difficulty of the heliocentric system is that the stars look the same all year long. How can this be, if the Earth travels around the Sun? The distance between the Earth and the Sun has been known since the seventeenth century, but it was only in 1837 that Friedrich Wilhelm Bessel\* became the first to observe the *parallax* of a star. This was a result of extremely careful measurements and complex calculations: he discovered the *Bessel functions* in order to realize it. He was able to find a star, 61 Cygni, whose apparent position changed with the month of the year. Seen over the whole year, the star describes a small ellipse in the sky, with an opening of  $0.588''$  (this is the modern value). After carefully eliminating all other possible explanations, he deduced that the change of position was due to the motion of the Earth around the Sun, and from the size of the ellipse he determined the distance to the star to be 105 Pm, or 11.1 light years.

Challenge 228 s

Bessel had thus managed for the first time to measure the distance of a star. By doing so he also proved that the Earth is not fixed with respect to the stars in the sky and that the Earth indeed revolves around the Sun. The motion itself was not a surprise. It confirmed the result of the mentioned aberration of light, discovered in 1728 by James Bradley\*\*

\* Friedrich Wilhelm Bessel (1784–1846), Westphalian astronomer who left a successful business career to dedicate his life to the stars, and became the foremost astronomer of his time.

\*\* James Bradley (1693–1762), English astronomer. He was one of the first astronomers to understand the value of precise measurement, and thoroughly modernized Greenwich. He discovered the aberration of light, a discovery that showed that the Earth moves and also allowed him to measure the speed of light; he also discovered the nutation of the Earth.



TABLE 24 Modern measurement data about the motion of the Earth (from [hpiers.obspm.fr/eop-pc](http://hpiers.obspm.fr/eop-pc)).

OBSERVABLE	SYMBOL	VALUE
Mean angular velocity of Earth	$\Omega$	72.921 150(1) $\mu\text{rad/s}$
Nominal angular velocity of Earth (epoch 1820)	$\Omega_N$	72.921 151 467 064 $\mu\text{rad/s}$
Conventional mean solar day (epoch 1820)	$d$	86 400 s
Conventional sidereal day	$d_{\text{si}}$	86 164.090 530 832 88 s
Ratio conv. mean solar day to conv. sidereal day	$k = d/d_{\text{si}}$	1.002 737 909 350 795
Conventional duration of the stellar day	$d_{\text{st}}$	86 164.098 903 691 s
Ratio conv. mean solar day to conv. stellar day	$k' = d/d_{\text{st}}$	1.002 737 811 911 354 88
General precession in longitude	$p$	5.028 792(2) $''/\text{a}$
Obliquity of the ecliptic (epoch 2000)	$\varepsilon_0$	23° 26' 21.4119''
Küstner-Chandler period in terrestrial frame	$T_{\text{KC}}$	433.1(1.7) d
Quality factor of the Küstner-Chandler peak	$Q_{\text{KC}}$	170
Free core nutation period in celestial frame	$T_{\text{F}}$	430.2(3) d
Quality factor of the free core nutation	$Q_{\text{F}}$	$2 \cdot 10^4$
Astronomical unit	AU	149 597 870.691(6) km
Sidereal year (epoch 2000)	$a_{\text{si}}$	365.256 363 004 d = 365 d 6 h 9 min 9.76 s
Tropical year	$a_{\text{tr}}$	365.242 190 402 d = 365 d 5 h 48 min 45.25 s
Mean Moon period	$T_{\text{M}}$	27.321 661 55(1) d
Earth's equatorial radius	$a$	6 378 136.6(1) m
First equatorial moment of inertia	$A$	$8.0101(2) \cdot 10^{37} \text{ kg m}^2$
Longitude of principal inertia axis $A$	$\lambda_A$	$-14.9291(10)^\circ$
Second equatorial moment of inertia	$B$	$8.0103(2) \cdot 10^{37} \text{ kg m}^2$
Axial moment of inertia	$C$	$8.0365(2) \cdot 10^{37} \text{ kg m}^2$
Equatorial moment of inertia of mantle	$A_{\text{m}}$	$7.0165 \cdot 10^{37} \text{ kg m}^2$
Axial moment of inertia of mantle	$C_{\text{m}}$	$7.0400 \cdot 10^{37} \text{ kg m}^2$
Earth's flattening	$f$	1/298.25642(1)
Astronomical Earth's dynamical flattening	$H = (C - A)/C$	0.003 273 794 9(1)
Geophysical Earth's dynamical flattening	$e = (C - A)/A$	0.003 284 547 9(1)
Earth's core dynamical flattening	$e_{\text{f}}$	0.002 646(2)
Second degree term in Earth's gravity potential	$J_2 = -(A + B - 1.082 635 9(1) \cdot 10^{-3} 2C)/(2MR^2)$	
Secular rate of $J_2$	$dJ_2/dt$	$-2.6(3) \cdot 10^{-11} / \text{a}$
Love number (measures shape distortion by tides)	$k_2$	0.3
Secular Love number	$k_{\text{s}}$	0.9383
Mean equatorial gravity	$g_{\text{eq}}$	9.780 3278(10) $\text{m/s}^2$
Geocentric constant of gravitation	$GM$	$3.986 004 418(8) \cdot 10^{14} \text{ m}^3/\text{s}^2$
Heliocentric constant of gravitation	$GM_{\odot}$	$1.327 124 420 76(50) \cdot 10^{20} \text{ m}^3/\text{s}^2$
Moon-to-Earth mass ratio	$\mu$	0.012 300 038 3(5)

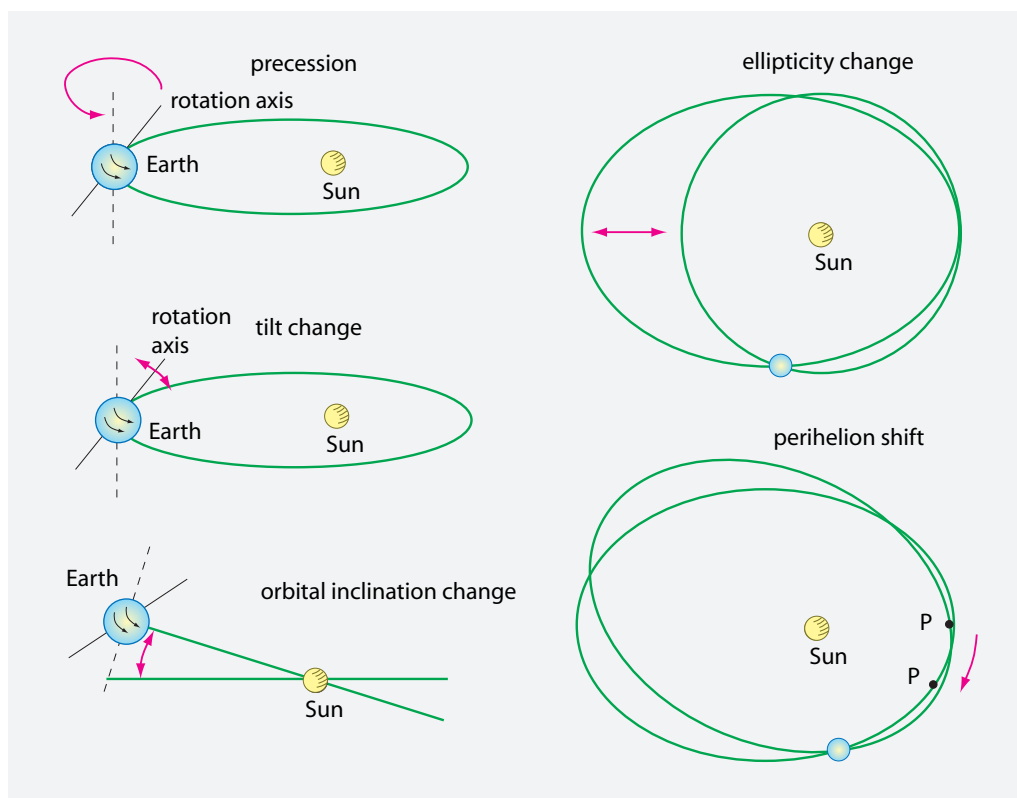


FIGURE 93 Changes in the Earth's motion around the Sun.

Vol. II, page 16

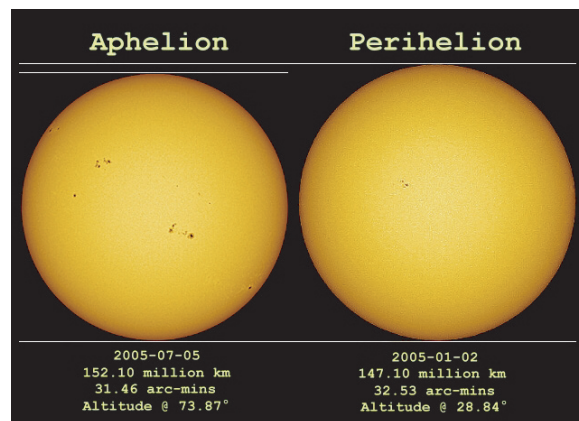
and to be discussed below; the Earth moves around the Sun.

With the improvement of telescopes, other motions of the Earth were discovered. In 1748, James Bradley announced that there is a small regular *change* of the precession, which he called *nutation*, with a period of 18.6 years and an angular amplitude of  $19.2''$ . Nutation occurs because the plane of the Moon's orbit around the Earth is not exactly the same as the plane of the Earth's orbit around the Sun. Are you able to confirm that this situation produces nutation?

Challenge 229 ny

Astronomers also discovered that the  $23.5^\circ$  tilt – or *obliquity* – of the Earth's axis, the angle between its intrinsic and its orbital angular momentum, actually changes from  $22.1^\circ$  to  $24.5^\circ$  with a period of 41 000 years. This motion is due to the attraction of the Sun and the deviations of the Earth from a spherical shape. In 1941, during the Second World War, the Serbian astronomer Milutin Milankovitch (1879–1958) retreated into solitude and studied the consequences. In his studies he realized that this 41 000 year period of the obliquity, together with an average period of 22 000 years due to precession,\* gives rise to the more than 20 *ice ages* in the last 2 million years. This happens through stronger or weaker irradiation of the poles by the Sun. The changing amounts of melted ice then lead to changes in average temperature. The last ice age had its peak about 20 000 years ago

\* In fact, the 25 800 year precession leads to three insolation periods, of 23 700, 22 400 and 19 000 years, due to the interaction between precession and perihelion shift.



**FIGURE 94** The angular size of the sun changes due to the elliptical motion of the Earth (© Anthony Ayiomamitis).

Ref. 109

and ended around 11 800 years ago; the next is still far away. A spectacular confirmation of the relation between ice age cycles and astronomy came through measurements of oxygen isotope ratios in ice cores and sea sediments, which allow the average temperature over the past million years to be tracked. **Figure 95** shows how closely the temperature follows the changes in irradiation due to changes in obliquity and precession.

The Earth's orbit also changes its *eccentricity* with time, from completely circular to slightly oval and back. However, this happens in very complex ways, not with periodic regularity, and is due to the influence of the large planets of the solar system on the Earth's orbit. The typical time scale is 100 000 to 125 000 years.

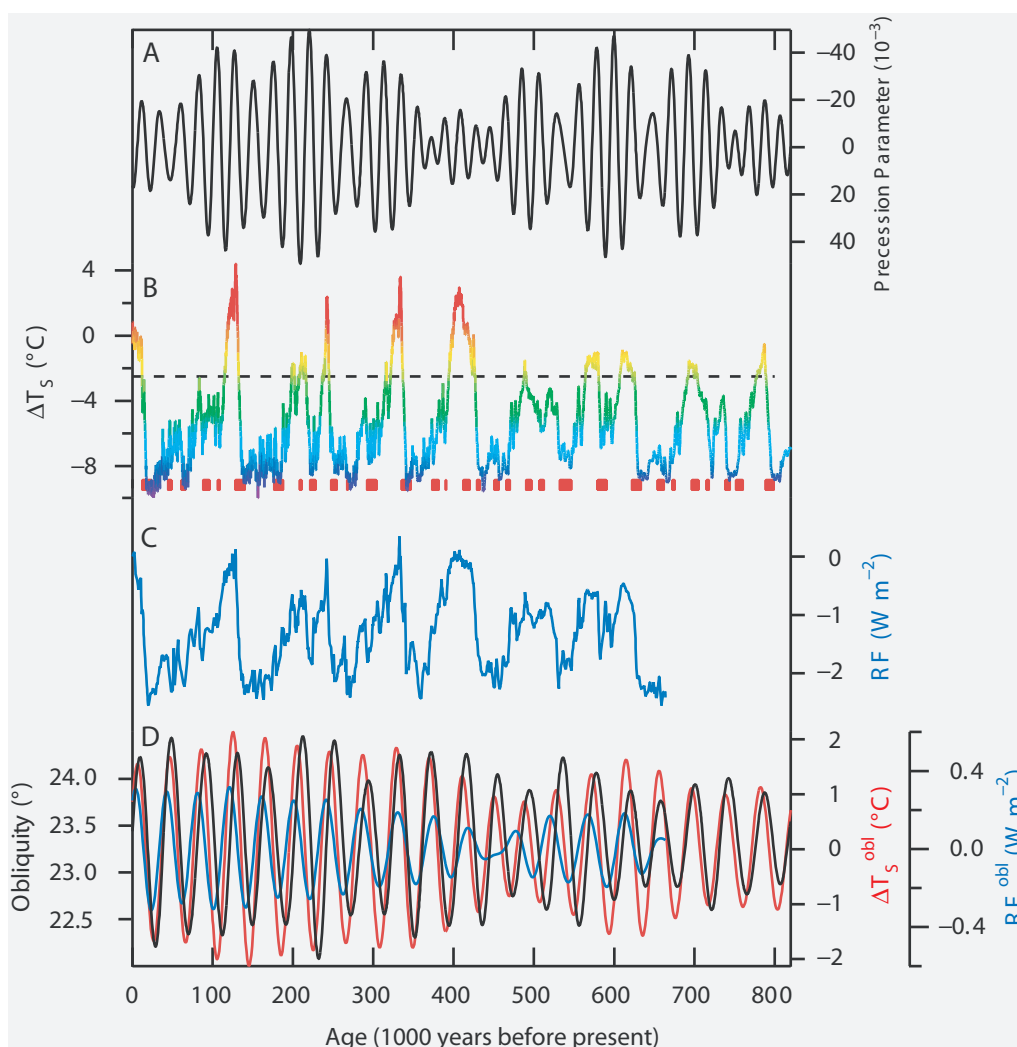
In addition, the Earth's orbit changes in *inclination* with respect to the orbits of the other planets; this seems to happen regularly every 100 000 years. In this period the inclination changes from  $+2.5^\circ$  to  $-2.5^\circ$  and back.

Even the direction in which the ellipse points changes with time. This so-called *perihelion shift* is due in large part to the influence of the other planets; a small remaining part will be important in the chapter on general relativity. It was the first piece of data confirming the theory.

Obviously, the length of the year also changes with time. The measured variations are of the order of a few parts in  $10^{11}$  or about 1 ms per year. However, knowledge of these changes and of their origins is much less detailed than for the changes in the Earth's rotation.

Ref. 110

The next step is to ask whether the Sun itself moves. Indeed it does. Locally, it moves with a speed of 19.4 km/s towards the constellation of Hercules. This was shown by William Herschel in 1783. But globally, the motion is even more interesting. The diameter of the galaxy is at least 100 000 light years, and we are located 26 000 light years from the centre. (This has been known since 1918; the centre of the galaxy is located in the direction of Sagittarius.) At our position, the galaxy is 1 300 light years thick; presently, we are 68 light years 'above' the centre plane. The Sun, and with it the solar system, takes about 225 million years to turn once around the galactic centre, its orbital velocity being around 220 km/s. It seems that the Sun will continue moving away from the galaxy plane until it is about 250 light years above the plane, and then move back, as shown in **Figure 96**. The oscillation period is estimated to be around 62 million years, and has been suggested as



**FIGURE 95** Modern measurements showing how Earth's precession parameter (black curve A) and obliquity (black curve D) influence the average temperature (coloured curve B) and the irradiation of the Earth (blue curve C) over the past 800 000 years: the obliquity deduced by Fourier analysis from the irradiation data RF (blue curve D) and the obliquity deduced by Fourier analysis from the temperature (red curve D) match the obliquity known from astronomical data (black curve D); sharp cooling events took place whenever the obliquity rose while the precession parameter was falling (marked red below the temperature curve) (© Jean Jouzel/Science from Ref. 109).

the mechanism for the mass extinctions of animal life on Earth, possibly because some gas cloud or some cosmic radiation source may be periodically encountered on the way. The issue is still a hot topic of research.

We turn around the galaxy centre because the formation of galaxies, like that of solar systems, always happens in a whirl. By the way, can you confirm from your own observation that our galaxy itself rotates?

Challenge 230 s

Finally, we can ask whether the galaxy itself moves. Its motion can indeed be observed because it is possible to give a value for the motion of the Sun through the universe,

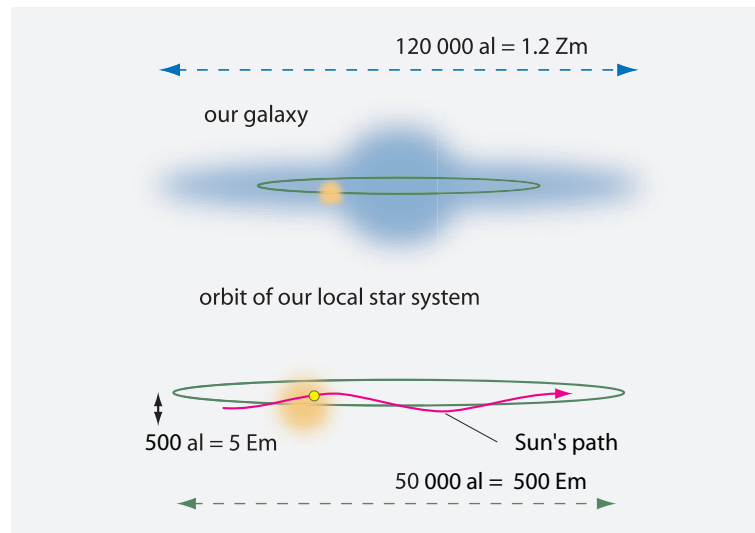


FIGURE 96 The motion of the Sun around the galaxy.

Ref. 111

defining it as the motion against the background radiation. This value has been measured to be 370 km/s. (The velocity of the *Earth* through the background radiation of course depends on the season.) This value is a combination of the motion of the Sun around the galaxy centre and of the motion of the galaxy itself. This latter motion is due to the gravitational attraction of the other, nearby galaxies in our local group of galaxies.\*

In summary, the Earth really moves, and it does so in rather complex ways. As Henri Poincaré would say, if we are in a given spot today, say the Panthéon in Paris, and come back to the same spot tomorrow at the same time, we are in fact 31 million kilometres away. This state of affairs would make time travel extremely difficult even if it were possible (which it is not); whenever you went back to the past, you would have to get to the old spot exactly!

#### IS VELOCITY ABSOLUTE? – THE THEORY OF EVERYDAY RELATIVITY

Why don't we feel all the motions of the Earth? The two parts of the answer were already given in 1632. First of all, as Galileo explained, we do not feel the accelerations of the Earth because the effects they produce are too small to be detected by our senses. Indeed, many of the mentioned accelerations do induce measurable effects only in high-precision experiments, e.g. in atomic clocks.

Vol. II, page 140

But the second point made by Galileo is equally important: it is impossible to feel that we are moving. We do not feel translational, unaccelerated motions because this is impossible *in principle*. Galileo discussed the issue by comparing the observations of two observers: one on the ground and another on the most modern means of unaccelerated transportation of the time, a ship. Galileo asked whether a man on the ground and a man in a ship moving at constant speed experience (or 'feel') anything different. Einstein used observers in trains. Later it became fashionable to use travellers in rockets. (What

\* This is roughly the end of the ladder. Note that the expansion of the universe, to be studied later, produces no motion.

Challenge 231 e will come next?) Galileo explained that only *relative* velocities between bodies produce effects, not the absolute values of the velocities. For the senses, there is no difference between constant, undisturbed motion, however rapid it may be, and rest. This is now called *Galileo's principle of relativity*. In everyday life we feel motion only if the means of transportation trembles (thus if it accelerates), or if we move against the air. Therefore Galileo concludes that two observers in straight and undisturbed motion against each other cannot say who is 'really' moving. Whatever their relative speed, neither of them 'feels' in motion.\*

Rest is relative. Or more clearly: rest is an observer-dependent concept. This result of Galilean physics is so important that Poincaré introduced the expression 'theory of relativity' and Einstein repeated the principle explicitly when he published his famous theory of special relativity. However, these names are awkward. Galilean physics is also a theory of relativity! The relativity of rest is common to *all* of physics; it is an essential aspect of motion.

Undisturbed or uniform motion has no observable effect; only *change* of motion does. As a result, every physicist can deduce something simple about the following statement by Wittgenstein:

Daß die Sonne morgen aufgehen wird, ist eine Hypothese; und das heißt:  
wir *wissen* nicht, ob sie aufgehen wird.\*\*

---

\* In 1632, in his *Dialogo*, Galileo writes: 'Shut yourself up with some friend in the main cabin below decks on some large ship, and have with you there some flies, butterflies, and other small flying animals. Have a large bowl of water with some fish in it; hang up a bottle that empties drop by drop into a wide vessel beneath it. With the ship standing still, observe carefully how the little animals fly with equal speed to all sides of the cabin. The fish swim indifferently in all directions; the drops fall into the vessel beneath; and, in throwing something to your friend, you need throw it no more strongly in one direction than another, the distances being equal: jumping with your feet together, you pass equal spaces in every direction. When you have observed all these things carefully (though there is no doubt that when the ship is standing still everything must happen in this way), have the ship proceed with any speed you like, so long as the motion is uniform and not fluctuating this way and that, you will discover not the least change in all the effects named, nor could you tell from any of them whether the ship was moving or standing still. In jumping, you will pass on the floor the same spaces as before, nor will you make larger jumps toward the stern than toward the prow even though the ship is moving quite rapidly, despite the fact that during the time you are in the air the floor under you will be going in a direction opposite to your jump. In throwing something to your companion, you will need no more force to get it to him whether he is in the direction of the bow or the stern, with yourself situated opposite. The droplets will fall as before into the vessel beneath without dropping toward the stern, although while the drops are in the air the ship runs many spans. The fish in their water will swim toward the front of their bowl with no more effort than toward the back, and will go with equal ease to bait placed anywhere around the edges of the bowl. Finally the butterflies and flies will continue their flights indifferently toward every side, nor will it ever happen that they are concentrated toward the stern, as if tired out from keeping up with the course of the ship, from which they will have been separated during long intervals by keeping themselves in the air. And if smoke is made by burning some incense, it will be seen going up in the form of a little cloud, remaining still and moving no more toward one side than the other. The cause of all these correspondences of effects is the fact that the ship's motion is common to all the things contained in it, and to the air also. That is why I said you should be below decks; for if this took place above in the open air, which would not follow the course of the ship, more or less noticeable differences would be seen in some of the effects noted.'

\*\* 'That the Sun will rise to-morrow, is an hypothesis; and that means that we do not *know* whether it will rise.' This well-known statement is found in Ludwig Wittgenstein, *Tractatus*, 6.36311.

Challenge 232 s The statement is *wrong*. Can you explain why Wittgenstein erred here, despite his strong desire not to?

### IS ROTATION RELATIVE?

When we turn rapidly, our arms lift. Why does this happen? How can our body detect whether we are rotating or not? There are two possible answers. The first approach, promoted by Newton, is to say that there is an absolute space; whenever we rotate against this space, the system reacts. The other answer is to note that whenever the arms lift, the stars also rotate, and in exactly the same manner. In other words, our body detects rotation because we move against the average mass distribution in space.

The most cited discussion of this question is due to Newton. Instead of arms, he explored the water in a rotating bucket. As usual for philosophical issues, Newton's answer was guided by the mysticism triggered by his father's early death. Newton saw absolute space as a religious concept and was not even able to conceive an alternative. Newton thus sees rotation as an absolute concept. Most modern scientist have fewer problems and more common sense than Newton; as a result, today's consensus is that rotation effects are due to the mass distribution in the universe: rotation is relative. However, we have to be honest; the question cannot be settled by Galilean physics. We will need general relativity.

### CURIOSITIES AND FUN CHALLENGES ABOUT RELATIVITY

Challenge 233 e When travelling in the train, you can test Galileo's statement about everyday relativity of motion. Close your eyes and ask somebody to turn you around many times: are you able to say in which direction the train is running?

\* \*

Challenge 234 s A good bathroom scale, used to determine the weight of objects, does not show a constant weight when you step on it and stay motionless. Why not?

\* \*

Challenge 235 s If a gun located at the Equator shoots a bullet vertically, where does the bullet fall?

\* \*

Challenge 236 s Why are most rocket launch sites as near as possible to the Equator?

\* \*

Ref. 112 Would travelling through interplanetary space be healthy? People often fantasize about long trips through the cosmos. Experiments have shown that on trips of long duration, cosmic radiation, bone weakening and muscle degeneration are the biggest dangers. Many medical experts question the viability of space travel lasting longer than a couple of years. Other dangers are rapid sunburn, at least near the Sun, and exposure to the vacuum. So far only one man has experienced vacuum without protection. He lost consciousness after 14 seconds, but survived unharmed.

\* \*



Challenge 237 s In which direction does a flame lean if it burns inside a jar on a rotating turntable?

\* \*

A ping-pong ball is attached by a string to a stone, and the whole is put under water in a jar. The set-up is shown in Figure 97. Now the jar is accelerated horizontally. In which direction does the ball move? What do you deduce for a jar at rest?

Challenge 238 s

\* \*

Galileo's principle of everyday relativity states that it is impossible to determine an absolute velocity. It is equally impossible to determine an absolute position, an absolute time and an absolute direction. Is this correct?

Challenge 239 ny

\* \*

Does *centrifugal acceleration* exist? Most university students go through the shock of meeting a teacher who says that it doesn't because it is a 'fictitious' quantity, in the face of what one experiences every day in a car when driving around a bend. Simply ask the teacher who denies it to define 'existence'. (The definition physicists usually use is given later on.) Then check whether the definition applies to the term and make up your own mind.

Vol. III, page 230

Challenge 240 s

Whether you like the term 'centrifugal acceleration' or avoid it by using its negative, the so-called *centripetal acceleration*, you should know it is calculated. We use a simple trick. For an object in circular motion of radius  $r$ , the magnitude  $v$  of the velocity  $\mathbf{v} = d\mathbf{x}/dt$  is  $v = 2\pi r/T$ . The vector  $\mathbf{v}$  behaves over time exactly like the position of the object: it rotates continuously. Therefore, the magnitude  $a$  of the centrifugal/centripetal acceleration  $\mathbf{a} = d\mathbf{v}/dt$  is given by the corresponding expression, namely  $a = 2\pi v/T$ . Eliminating  $T$ , we find that the centrifugal/centripetal acceleration  $a$  of a body rotating at speed  $v$  at radius  $r$  is given by

$$a = \frac{v^2}{r} = \omega^2 r. \quad (32)$$

This is the acceleration we feel when sitting in a car that goes around a bend.

\* \*

Rotation holds a surprise for anybody who studies it carefully. Angular momentum is a quantity with a magnitude and a direction. However, it is not a vector, as any mirror shows. The angular momentum of a body circling in a plane parallel to a mirror behaves in a different way from a usual arrow: its mirror image is not reflected if it points towards the mirror! You can easily check this for yourself. For this reason, angular momentum is called a *pseudovector*. The fact has no important consequences in classical physics; but we have to keep it in mind for later occasions.

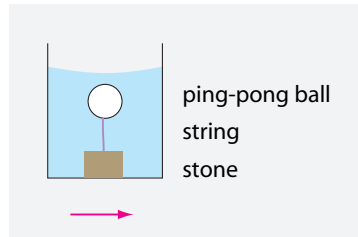
Challenge 241 e

\* \*

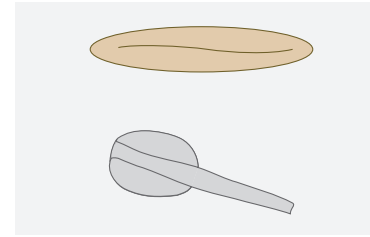
What is the best way to transport a number of full coffee or tea cups while at the same time avoiding spilling any precious liquid?

Challenge 242 s

\* \*



**FIGURE 97** How does the ball move when the jar is accelerated in direction of the arrow?



**FIGURE 98** The famous Celtic stone and a version made with a spoon.

Challenge 243 s

The Moon recedes from the Earth by 3.8 cm a year, due to friction. Can you find the mechanism responsible for the effect?

\* \*

What are earthquakes? *Earthquakes* are large examples of the same process that make a door squeak. The continental plates correspond to the metal surfaces in the joints of the door.

Earthquakes can be described as energy sources. The Richter scale is a direct measure of this energy. The *Richter magnitude*  $M_s$  of an earthquake, a pure number, is defined from its energy  $E$  in joule via

$$M_s = \frac{\log(E/1 \text{ J}) - 4.8}{1.5}. \quad (33)$$

Challenge 244 s

The strange numbers in the expression have been chosen to put the earthquake values as near as possible to the older, qualitative Mercalli scale (now called EMS98) that classifies the intensity of earthquakes. However, this is not fully possible; the most sensitive instruments today detect earthquakes with magnitudes of  $-3$ . The highest value ever measured was a Richter magnitude of 10, in Chile in 1960. Magnitudes above 12 are probably impossible. (Can you show why?)

\* \*

Ref. 89

**Figure 98** shows the so-called *Celtic wobble stone* (also called *wobblestone* or *rattleback*), a stone that starts rotating on a plane surface when it is put into oscillation. The size can vary between a few centimetres and a few metres. By simply bending a spoon one can realize a primitive form of this strange device, if the bend is not completely symmetrical. The rotation is always in the same direction. If the stone is put into rotation in the wrong direction, after a while it stops and starts rotating in the other sense! Can you explain the effect?

Challenge 245 d

\* \*

Challenge 246 ny

What is the motion of the point on the surface of the Earth that has Sun in its zenith (i.e., vertically above it), when seen on a map of the Earth during one day, and day after day?

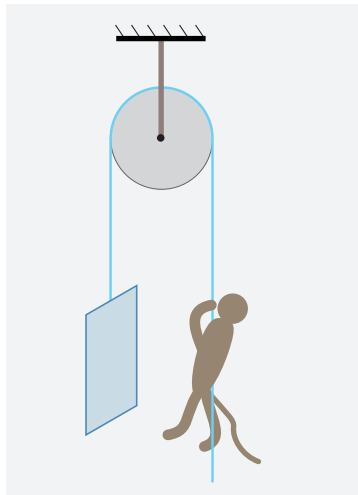


FIGURE 99 What happens when the ape climbs?

\* \*

The moment of inertia of a body depends on the shape of the body; usually, angular momentum and the angular velocity do not point in the same direction. Can you confirm this with an example?

Challenge 247 s

\* \*

Can it happen that a satellite dish for geostationary TV satellites focuses the sunshine onto the receiver?

Challenge 248 s

\* \*

Why is it difficult to fire a rocket from an aeroplane in the direction opposite to the motion of the plane?

Challenge 249 s

\* \*

An ape hangs on a rope. The rope hangs over a wheel and is attached to a mass of equal weight hanging down on the other side, as shown in Figure 99. The rope and the wheel are massless and frictionless. What happens when the ape climbs the rope?

Challenge 250 s

\* \*

Challenge 251 s Can a water skier move with a higher speed than the boat pulling him?

\* \*

Take two cans of the same size and weight, one full of ravioli and one full of peas. Which one rolls faster on an inclined plane?

Challenge 252 e

\* \*

Challenge 253 s What is the moment of inertia of a homogeneous sphere?

\* \*



**FIGURE 100** A long exposure of the stars at night - over the Gemini telescope in Hawaii (© Gemini Observatory/AURA).

The moment of inertia is determined by the values of its three principal axes. These are all equal for a sphere and for a cube. Does it mean that it is impossible to distinguish a sphere from a cube by their inertial behaviour?

Challenge 254 s

\* \*

You might know the 'Dynabee', a hand-held gyroscopic device that can be accelerated to high speed by proper movements of the hand. How does it work?

Challenge 255 d

\* \*

It is possible to make a spinning top with a metal paper clip. It is even possible to make one of those tops that turn onto their head when spinning. Can you find out how?

Challenge 256 s

\* \*

Is it true that the Moon in the first quarter in the northern hemisphere looks like the Moon in the last quarter in the southern hemisphere?

Challenge 257 s

\* \*

An impressive confirmation that the Earth is round can be seen at sunset, if one turns, against usual habits, one's back on the Sun. On the eastern sky one can see the impressive rise of the Earth's shadow. (In fact, more precise investigations show that it is not the shadow of the Earth alone, but the shadow of its ionosphere.) One can admire a vast shadow rising over the whole horizon, clearly having the shape of a segment of a huge

circle.

\* \*

Challenge 258 s How would Figure 100 look if taken at the Equator?

\* \*

Challenge 259 e Since the Earth is round, there are many ways to drive from one point on the Earth to another along a circle segment. This has interesting consequences for volley balls and for girl-watching. Take a volleyball and look at its air inlet. If you want to move the inlet to a different position with a simple rotation, you can choose the rotation axis in many different ways. Can you confirm this? In other words, when we look in a given direction and then want to look in another, the eye can accomplish this change in different ways. The option chosen by the human eye had already been studied by medical scientists in the eighteenth century. It is called *Listing's law*.<sup>\*</sup> It states that all axes that nature chooses lie in one plane. Can you imagine its position in space? Men have a real interest that this mechanism is strictly followed; if not, looking at girls on the beach could cause the muscles moving the eyes to get knotted up.

Challenge 260 s

#### LEGS OR WHEELS? – AGAIN

The acceleration and deceleration of standard wheel-driven cars is never much greater than about  $1 g = 9.8 \text{ m/s}^2$ , the acceleration due to gravity on our planet. Higher accelerations are achieved by motorbikes and racing cars through the use of suspensions that divert weight to the axes and by the use of spoilers, so that the car is pushed downwards with more than its own weight. Modern spoilers are so efficient in pushing a car towards the track that racing cars could race on the roof of a tunnel without falling down.

Through the use of special tyres these downwards forces are transformed into grip; modern racing tyres allow forward, backward and sideways accelerations (necessary for speed increase, for braking and for turning corners) of about 1.1 to 1.3 times the load. Engineers once believed that a factor 1 was the theoretical limit and this limit is still sometimes found in textbooks; but advances in tyre technology, mostly by making clever use of interlocking between the tyre and the road surface as in a gear mechanism, have allowed engineers to achieve these higher values. The highest accelerations, around  $4 g$ , are achieved when part of the tyre melts and glues to the surface. Special tyres designed to make this happen are used for dragsters, but high performance radio-controlled model cars also achieve such values.

Ref. 113 How do all these efforts compare to using legs? High jump athletes can achieve peak accelerations of about 2 to  $4 g$ , cheetahs over  $3 g$ , bushbabies up to  $13 g$ , locusts about  $18 g$ , and fleas have been measured to accelerate about  $135 g$ . The maximum acceleration known for animals is that of click beetles, a small insect able to accelerate at over  $2000 \text{ m/s}^2 = 200 g$ , about the same as an airgun pellet when fired. Legs are thus definitively more efficient accelerating devices than wheels – a cheetah can easily beat any car

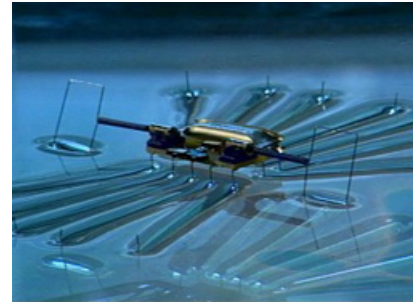
\* If you are interested in learning in more detail how nature and the eye cope with the complexities of three dimensions, see the [schorlab.berkeley.edu/vilis/whatisLL.htm](http://schorlab.berkeley.edu/vilis/whatisLL.htm) and [www.physpharm.fmd.uwo.ca/undergrad/llconsequencesweb/ListingsLaw/perceptual1.htm](http://www.physpharm.fmd.uwo.ca/undergrad/llconsequencesweb/ListingsLaw/perceptual1.htm) websites.



**FIGURE 101** A basilisk lizard (*Basiliscus basiliscus*) running on water, with a total length of about 25 cm, showing how the propulsive leg pushes into the water (© TERRA).



**FIGURE 102** A water strider, total size about 10 mm (© Charles Lewallen).



**FIGURE 103** A water walking robot, total size about 20 mm (© AIP).

or motorbike – and evolution developed legs, instead of wheels, to improve the chances of an animal in danger getting to safety. In short, legs *outperform* wheels.

Challenge 261 s

There are other reasons for using legs instead of wheels. (Can you name some?) For example, legs, unlike wheels, allow walking on water. Most famous for this ability is the *basilisk*,\* a lizard living in Central America. This reptile is about 50 cm long and has a mass of about 90 g. It looks like a miniature *Tyrannosaurus rex* and is able to run over water surfaces on its hind legs. The motion has been studied in detail with high-speed cameras and by measurements using aluminium models of the animal's feet. The experiments show that the feet slapping on the water provides only 25 % of the force necessary to run above water; the other 75 % is provided by a pocket of compressed air that the basilisks create between their feet and the water once the feet are inside the water. In fact, basilisks mainly walk on air. (Both effects used by basilisks are also found in fast canoeing.) It was calculated that humans are also able to walk on water, provided their feet hit the water with a speed of 100 km/h using the simultaneous physical power of 15 sprinters. Quite a feat for all those who ever did so.

Ref. 114

Ref. 115

There is a second method of walking and running on water; this second method even allows its users to remain immobile on top of the water surface. This is what water striders, insects of the family *Gerridae* with a overall length of up to 15 mm, are able to do

\* In the Middle Ages, the term 'basilisk' referred to a mythical monster supposed to appear shortly before the end of the world. Today, it is a small reptile in the Americas.



(together with several species of spiders). Like all insects, the water strider has six legs (spiders have eight). The water strider uses the back and front legs to hover over the surface, helped by thousands of tiny hairs attached to its body. The hairs, together with the surface tension of water, prevent the strider from getting wet. If you put shampoo into the water, the water strider sinks and can no longer move. The water strider uses its large middle legs as oars to advance over the surface, reaching speeds of up to 1 m/s doing so. In short, water striders actually row over water. The same mechanism is used by the

Ref. 116

small robots that can move over water and were developed by Metin Sitti and his group. Legs pose many interesting problems. Engineers know that a staircase is comfortable to walk only if for each step the depth  $l$  plus *twice* the height  $h$  is a constant:  $l + 2h = 0.63 \pm 0.02$  m. This is the so-called *staircase formula*. Why does it hold?

Challenge 262 s

Challenge 263 s

All animals have an *even* number of legs. Do you know an exception? Why not? In fact, one can argue that no animal has less than four legs. Why is this the case?

On the other hand, all animals with two legs have the legs side by side, whereas systems with two wheels have them one behind the other. Why is this not the other way round?

Challenge 264 e

Legs also provide simple distance rulers: just count your steps. In 2006, it was discovered that this method is used by certain ant species, such as *Cataglyphis fortis*. They can count to at least 25 000, as shown by Matthias Wittlinger and his team. These ants use the ability to find the shortest way back to their home even in structureless desert terrain.

Ref. 117

Ref. 118

Why do 100 m sprinters run faster than ordinary people? A thorough investigation shows that the speed  $v$  of a sprinter is given by

$$v = f L_{\text{stride}} = f L_c \frac{F_c}{W}, \quad (34)$$

where  $f$  is the frequency of the legs,  $L_{\text{stride}}$  is the stride length,  $L_c$  is the contact length – the length that the sprinter advances during the time the foot is in contact with the floor –  $W$  the weight of the sprinter, and  $F_c$  the average force the sprinter exerts on the floor during contact. It turns out that the frequency  $f$  is almost the same for all sprinters; the only way to be faster than the competition is to increase the stride length  $L_{\text{stride}}$ . Also the contact length  $L_c$  varies little between athletes. Increasing the stride length thus requires that the athlete hits the ground with strong strokes. This is what athletic training for sprinters has to achieve.

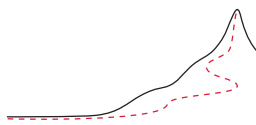
### SUMMARY ON GALILEAN RELATIVITY

Undisturbed or inertial motion cannot be felt or measured. It is thus impossible to distinguish motion from rest; the distinction depends on the observer: motion of bodies is relative. That is why the soil below our feet seems so stable to us, even though it moves with high speed across the universe.

Only later on will we discover that one example of motion in nature is *not* relative: the motion of light. But we continue first with the study of motion transmitted over distance, without the use of any contact at all.







## CHAPTER 6

# MOTION DUE TO GRAVITATION

“Caddi come corpo morto cade.  
Dante, *Inferno*, c. V, v. 142.\*”

The first and main contact-free method to generate motion we discover in our environment is *height*. Waterfalls, snow, rain and falling apples all rely on it. It was one of the fundamental discoveries of physics that height has this property because there is an interaction between every body and the Earth. *Gravitation* produces an acceleration along the line connecting the centres of gravity of the body and the Earth. Note that in order to make this statement, it is necessary to realize that the Earth is a body in the same way as a stone or the Moon, that this body is finite and that therefore it has a centre and a mass. Today, these statements are common knowledge, but they are by no means evident from everyday personal experience.\*\*

How does gravitation change when two bodies are far apart? The experts on distant objects are the astronomers. Over the years they have performed numerous measurements of the movements of the Moon and the planets. The most industrious of all was Tycho Brahe\*\*\* who organized an industrial-scale search for astronomical facts sponsored by his king. His measurements were the basis for the research of his young assistant, the Swabian astronomer Johannes Kepler\*\*\*\* who found the first precise description of

\* 'I fell like dead bodies fall.' Dante Alighieri (1265, Firenze–1321, Ravenna), the powerful Italian poet.

\*\* In several myths about the creation or the organization of the world, such as the biblical one or the Indian one, the Earth is not an object, but an imprecisely defined entity, such as an island floating or surrounded by water with unclear boundaries and unclear method of suspension. Are you able to convince a friend that the Earth is round and not flat? Can you find another argument apart from the roundness of the Earth's shadow when it is visible on the Moon?

Challenge 265 s

Ref. 119

A famous crook, Robert Peary, claimed to have reached the North Pole in 1909. (In fact, Roald Amundsen reached both the South and the North Pole first.) Among others, Peary claimed to have taken a picture there, but that picture, which went round the world, turned out to be one of the proofs that he had not been there. Can you imagine how?

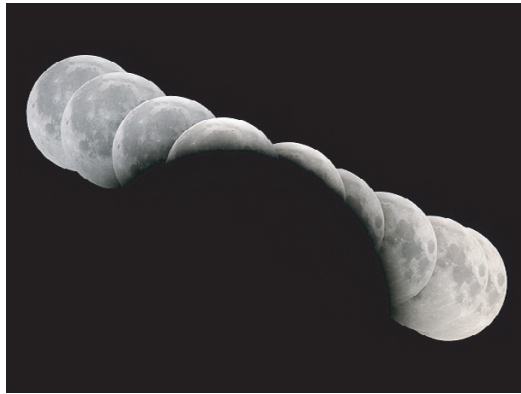
Challenge 266 s

Challenge 267 s

By the way, if the Earth is round, the top of two buildings is further apart than their base. Can this effect be measured?

\*\*\* Tycho Brahe (1546–1601), famous Danish astronomer, builder of Uraniborg, the astronomical castle. He consumed almost 10 % of the Danish gross national product for his research, which produced the first star catalogue and the first precise position measurements of planets.

\*\*\*\* Johannes Kepler (1571 Weil der Stadt–1630 Regensburg) studied Protestant theology and became a teacher of mathematics, astronomy and rhetoric. He helped his mother to defend herself successfully in a trial where she was accused of witchcraft. His first book on astronomy made him famous, and he became assistant to Tycho Brahe and then, at his teacher's death, the Imperial Mathematician. He was the first to



**FIGURE 104** How to compare the radius of the Earth with that of the Moon during a partial lunar eclipse (© Anthony Ayiomamitis).

Vol. III, page 230

planetary motion. In 1684, all observations of planets and stones were condensed into an astonishingly simple result by the English physicist Robert Hooke:\* every body of mass  $M$  attracts any other body towards its centre with an acceleration whose magnitude  $a$  is given by

$$a = G \frac{M}{r^2} \quad (35)$$

where  $r$  is the centre-to-centre distance of the two bodies. This is called the *universal 'law' of gravitation*, or universal gravity, because it is valid in general. The proportionality constant  $G$  is called the *gravitational constant*; it is one of the fundamental constants of nature, like the speed of light or the quantum of action. More about it will be said shortly. The effect of gravity thus decreases with increasing distance; gravity depends on the inverse distance squared of the bodies under consideration. If bodies are small compared with the distance  $r$ , or if they are spherical, expression (35) is correct as it stands; for non-spherical shapes the acceleration has to be calculated separately for each part of the bodies and then added together.

Ref. 120

This inverse square dependence is often called Newton's 'law' of gravitation, because the English physicist Isaac Newton proved more elegantly than Hooke that it agreed with all astronomical and terrestrial observations. Above all, however, he organized a better public relations campaign, in which he falsely claimed to be the originator of the idea.

Newton published a simple proof showing that this description of astronomical motion also gives the correct description for stones thrown through the air, down here on 'father Earth'. To achieve this, he compared the acceleration  $a_m$  of the Moon with that of stones  $g$ . For the ratio between these two accelerations, the inverse square relation predicts a value  $g/a_m = d_m^2/R^2$ , where  $d_m$  the distance of the Moon and  $R$  is the radius of the Earth. The Moon's distance can be measured by triangulation, comparing the pos-

---

use mathematics in the description of astronomical observations, and introduced the concept and field of 'celestial physics'.

\* Robert Hooke (1635–1703), important English physicist and secretary of the Royal Society. Apart from discovering the inverse square relation and many others, such as Hooke's 'law', he also wrote the *Micrographia*, a beautifully illustrated exploration of the world of the very small.

ition of the Moon against the starry background from two different points on Earth.\* The result is  $d_m/R = 60 \pm 3$ , depending on the orbital position of the Moon, so that an average ratio  $g/a_m = 3.6 \cdot 10^3$  is predicted from universal gravity. But both accelerations can also be measured directly. At the surface of the Earth, stones are subject to an acceleration due to gravitation with magnitude  $g = 9.8 \text{ m/s}^2$ , as determined by measuring the time that stones need to fall a given distance. For the Moon, the definition of acceleration,  $a = dv/dt$ , in the case of circular motion – roughly correct here – gives  $a_m = d_m(2\pi/T)^2$ , where  $T = 2.4 \text{ Ms}$  is the time the Moon takes for one orbit around the Earth.\*\* The measurement of the radius of the Earth\*\*\* yields  $R = 6.4 \text{ Mm}$ , so that the average Earth–Moon distance is  $d_m = 0.38 \text{ Gm}$ . One thus has  $g/a_m = 3.6 \cdot 10^3$ , in agreement with the above prediction. With this famous ‘Moon calculation’ we have thus shown that the inverse square property of gravitation indeed describes both the motion of the Moon and that of stones. You might want to deduce the value of  $GM$ .

Challenge 271 s

From the observation that on the Earth all motion eventually comes to rest, whereas in the sky all motion is eternal, Aristotle and many others had concluded that motion in the sublunar world has different properties from motion in the translunar world. Several thinkers had criticized this distinction, notably the French philosopher and rector of the University of Paris, Jean Buridan.\*\*\*\* The Moon calculation was the most important result showing this distinction to be wrong. This is the reason for calling the expression (35) the *universal* ‘law’ of gravitation.

Ref. 123

This result allows us to answer another old question. Why does the Moon not fall from the sky? Well, the preceding discussion showed that *fall* is motion due to gravitation. Therefore the Moon actually *is* falling, with the peculiarity that instead of falling *towards* the Earth, it is continuously falling *around* it. Figure 105 illustrates the idea. The Moon is continuously missing the Earth.\*\*\*\*\*

\* The first precise – but not the first – measurement was achieved in 1752 by the French astronomers Lalande and La Caille, who simultaneously measured the position of the Moon seen from Berlin and from Le Cap.

\*\* This expression for the centripetal acceleration is deduced easily by noting that for an object in circular motion, the magnitude  $v$  of the velocity  $\mathbf{v} = d\mathbf{x}/dt$  is given as  $v = 2\pi r/T$ . The drawing of the vector  $\mathbf{v}$  over time, the so-called *hodograph*, shows that it behaves exactly like the position of the object. Therefore the magnitude  $a$  of the acceleration  $\mathbf{a} = d\mathbf{v}/dt$  is given by the corresponding expression, namely  $a = 2\pi v/T$ .

Challenge 268 s

Ref. 121

\*\*\* This is the hardest quantity to measure oneself. The most surprising way to determine the Earth’s size is the following: watch a sunset in the garden of a house, with a stopwatch in hand. When the last ray of the Sun disappears, start the stopwatch and run upstairs. There, the Sun is still visible; stop the stopwatch when the Sun disappears again and note the time  $t$ . Measure the height distance  $h$  of the two eye positions where the Sun was observed. The Earth’s radius  $R$  is then given by  $R = k h/t^2$ , with  $k = 378 \cdot 10^6 \text{ s}^2$ .

Challenge 269 s

Ref. 122

There is also a simple way to measure the distance to the Moon, once the size of the Earth is known. Take a photograph of the Moon when it is high in the sky, and call  $\theta$  its zenith angle, i.e., its angle from the vertical. Make another photograph of the Moon a few hours later, when it is just above the horizon. On this picture, unlike a common optical illusion, the Moon is smaller, because it is further away. With a sketch the reason for this becomes immediately clear. If  $q$  is the ratio of the two angular diameters, the Earth–Moon distance  $d_m$  is given by the relation  $d_m^2 = R^2 + (2Rq \cos \theta / (1 - q^2))^2$ . Enjoy finding its derivation from the sketch.

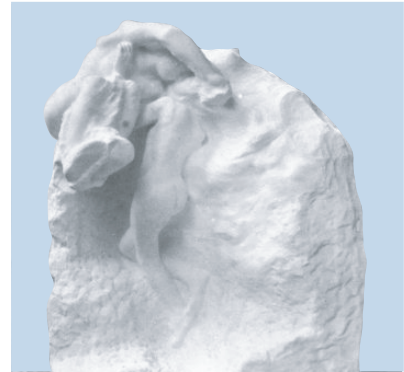
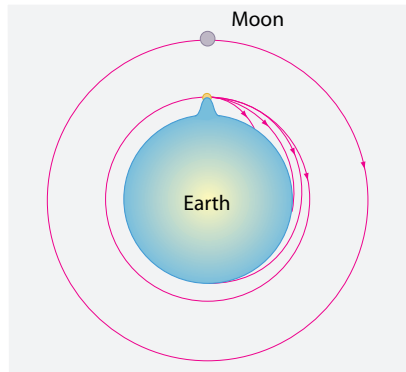
Page 63

Challenge 270 s

Another possibility is to determine the size of the Moon by comparing it with the size of the shadow of the Earth during a lunar eclipse, as shown in Figure 104. The distance to the Moon is then computed from its angular size, about  $0.5^\circ$ .

\*\*\*\* Jean Buridan (c. 1295 to c. 1366) was also one of the first modern thinkers to discuss the rotation of the Earth about an axis.

\*\*\*\*\* Another way to put it is to use the answer of the Dutch physicist Christiaan Huygens (1629–1695):



**FIGURE 105** A physicist's and an artist's view of the fall of the Moon: a diagram by Christiaan Huygens (not to scale) and a marble statue by Auguste Rodin.



**FIGURE 106** A precision second pendulum, thus about 1 m in length; almost at the upper end, the vacuum chamber that compensates for changes in atmospheric pressure; towards the lower end, the wide construction that compensates for temperature variations of pendulum length; at the very bottom, the screw that compensates for local variations of the gravitational acceleration, giving a final precision of about 1 s per month (© Erwin Sattler OHG).

Universal gravity also explains why the Earth and most planets are (almost) spherical. Since gravity increases with decreasing distance, a liquid body in space will always try to form a spherical shape. Seen on a large scale, the Earth is indeed liquid. We also know that the Earth is cooling down – that is how the crust and the continents formed. The

the Moon does not fall from the sky because of the centrifugal acceleration. As explained on [page 133](#), this explanation is nowadays out of favour at most universities.

Ref. 124  
Challenge 272 d

There is a beautiful problem connected to the left side of the figure: Which points on the surface of the Earth can be hit by shooting from a mountain? And which points can be hit by shooting horizontally?

TABLE 25 Some measured values of the acceleration due to gravity.

P L A C E	V A L U E
Poles	9.83 m/s <sup>2</sup>
Trondheim	9.8215243 m/s <sup>2</sup>
Hamburg	9.8139443 m/s <sup>2</sup>
Munich	9.8072914 m/s <sup>2</sup>
Rome	9.8034755 m/s <sup>2</sup>
Equator	9.78 m/s <sup>2</sup>
Moon	1.6 m/s <sup>2</sup>
Sun	273 m/s <sup>2</sup>

sphericity of smaller solid objects encountered in space, such as the Moon, thus means that they used to be liquid in older times.

### PROPERTIES OF GRAVITATION

Page 157

Challenge 273 ny

Gravitation implies that the path of a stone is not a parabola, as stated earlier, but actually an ellipse around the centre of the Earth. This happens for exactly the same reason that the planets move in ellipses around the Sun. Are you able to confirm this statement?

Universal gravitation allows us to solve a mystery. The puzzling acceleration value  $g = 9.8 \text{ m/s}^2$  we encountered in equation (5) is thus due to the relation

$$g = GM_{\text{Earth}}/R_{\text{Earth}}^2 \quad (36)$$

The equation can be deduced from equation (35) by taking the Earth to be spherical. The everyday acceleration of gravity  $g$  thus results from the size of the Earth, its mass, and the universal constant of gravitation  $G$ . Obviously, the value for  $g$  is almost constant on the surface of the Earth because the Earth is almost a sphere. Expression (36) also explains why  $g$  gets smaller as one rises above the Earth, and the deviations of the shape of the Earth from sphericity explain why  $g$  is different at the poles and higher on a plateau. (What would it be on the Moon? On Mars? On Jupiter?)

Challenge 274 s

By the way, it is possible to devise a simple machine, other than a yo-yo, that slows down the effective acceleration of gravity by a known amount, so that one can measure its value more easily. Can you imagine it?

Challenge 275 s

Note that 9.8 is roughly  $\pi^2$ . This is *not* a coincidence: the metre has been chosen in such a way to make this (roughly) correct. The period  $T$  of a swinging pendulum, i.e., a

Challenge 276 s back and forward swing, is given by\*

$$T = 2\pi\sqrt{\frac{l}{g}}, \quad (37)$$

where  $l$  is the length of the pendulum, and  $g = 9.8 \text{ m/s}^2$  is the gravitational acceleration. (The pendulum is assumed to consist of a compact mass attached to a string of negligible mass.) The oscillation time of a pendulum depends only on the length of the string and on  $g$ , thus on the planet it is located on.

Challenge 278 e If the metre had been defined such that  $T/2 = 1 \text{ s}$ , the value of the normal acceleration  $g$  would have been exactly  $\pi^2 \text{ m/s}^2$ . Indeed, this was the first proposal for the definition of the metre; it was made in 1673 by Huygens and repeated in 1790 by Talleyrand, but was rejected by the conference that defined the metre because variations in the value of  $g$  with geographical position, temperature-induced variations of the length of a pendulum and even air pressure variations induce errors that are too large to yield a definition of useful precision. (Indeed, all these effects must be corrected in pendulum clocks, as shown in Figure 106.)

Ref. 125 Finally, the proposal was made to define the metre as  $1/40\,000\,000$  of the circumference of the Earth through the poles, a so-called *meridian*. This proposal was almost identical to – but much more precise than – the pendulum proposal. The meridian definition of the metre was then adopted by the French national assembly on 26 March 1791, with the statement that ‘a meridian passes under the feet of every human being, and all meridians are equal’. (Nevertheless, the distance from Equator to the poles is not exactly 10 Mm; that is a strange story. One of the two geographers who determined the size of the first metre stick was dishonest. The data he gave for his measurements – the general method of which is shown in Figure 107 – was fabricated. Thus the first official metre stick in Paris was shorter than it should be.)

But we can still ask: Why does the Earth have the mass and size it has? And why does  $G$  have the value it has? The first question asks for a history of the solar system; it is still unanswered and is topic of research. The second question is addressed in Appendix B.

If all objects attract each other, it should also be the case for objects in everyday life. Gravity must also work *sideways*. This is indeed the case, even though the effects are so small that they were measured only long after universal gravity had predicted them. Measuring this effect allows the gravitational constant  $G$  to be determined.

Note that measuring the gravitational constant  $G$  is also the only way to determine the mass of the *Earth*. The first to do so, in 1798, was the English physicist Henry Cavendish; he used the machine, ideas and method of John Michell who died when attempting

---

\* Formula (37) is noteworthy mainly for all that is missing. The period of a pendulum does *not* depend on the mass of the swinging body. In addition, the period of a pendulum does *not* depend on the amplitude. (This is true as long as the oscillation angle is smaller than about  $15^\circ$ .) Galileo discovered this as a student, when observing a chandelier hanging on a long rope in the dome of Pisa. Using his heartbeat as a clock he found that even though the amplitude of the swing got smaller and smaller, the time for the swing stayed the same.

Challenge 277 s A leg also moves like a pendulum, when one walks normally. Why then do taller people tend to walk faster? Is the relation also true for animals of different size?





FIGURE 107 The measurements that lead to the definition of the metre (© Ken Alder).

the experiment. Michell and Cavendish\* called the aim and result of their experiments ‘weighing the Earth’.

The idea of Michell was to suspend a horizontal handle, with two masses at the end, at the end of a long metal wire. He then approached two large masses at the two ends of the handle, avoiding any air currents, and measured how much the handle rotated. Figure 108 shows how to repeat this experiment in your basement, and Figure 109 how to perform it when you have a larger budget.

The value the gravitational constant  $G$  found in more elaborate versions of the Michell–Cavendish experiments is

$$G = 6.7 \cdot 10^{-11} \text{ Nm}^2/\text{kg}^2 = 6.7 \cdot 10^{-11} \text{ m}^3/\text{kg s}^2 . \quad (38)$$

Cavendish’s experiment was thus the first to confirm that gravity also works sideways. The experiment also allows deducing the mass  $M$  of the Earth from its radius  $R$  and the relation  $g = GM/R^2$ . Finally, as we will see later on, this experiment proves, if we keep in mind that the speed of light is finite and invariant, that space is curved. All this is achieved with this simple set-up!

Gravitation is weak. For example, two average people 1 m apart feel an acceleration towards each other that is less than that exerted by a common fly when landing on the skin. Therefore we usually do not notice the attraction to other people. When we notice it, it is much stronger than that. The measurement of  $G$  thus proves that gravitation

\* Henry Cavendish (1731–1810) was one of the great geniuses of physics; rich but solitary, he found many rules of nature, but never published them. Had he done so, his name would be much more well known. John Michell (1724–1793) was church minister, geologist and amateur astronomer.



**FIGURE 108** An experiment that allows weighing the Earth and proving that gravity also works sideways and curves space. Top left and right: a torsion balance made of foam and lead, with petanque masses as fixed masses; centre right: a torsion balance made of wood and lead, with stones as fixed masses; bottom: a time sequence showing how the stones do attract the lead (© John Walker).

Vol. III, page 15

cannot be the true cause of people falling in love, and also that sexual attraction is not of gravitational origin, but of a different source. The physical basis for love and sexual attraction will be studied later in our walk: it is called *electromagnetism*.

### THE GRAVITATIONAL POTENTIAL

Gravity has an important property: all effects of gravitation can also be described by another observable, namely the (*gravitational*) *potential*  $\varphi$ . We then have the simple relation that the acceleration is given by the *gradient* of the potential

$$\mathbf{a} = -\nabla\varphi \quad \text{or} \quad \mathbf{a} = -\text{grad } \varphi . \quad (39)$$

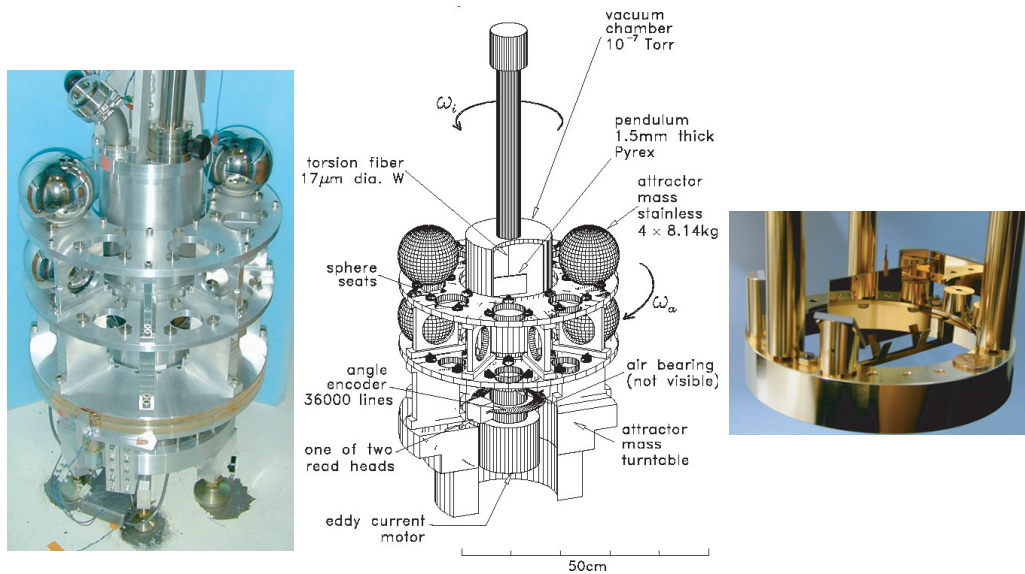


FIGURE 109 A modern precision torsion balance experiment to measure the gravitational constant, performed at the University of Washington (© Eöt-Wash Group).

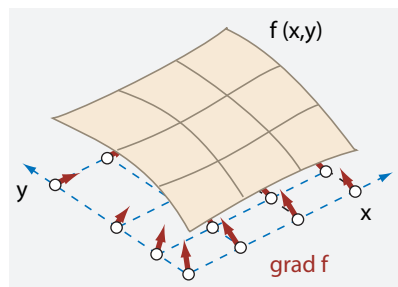


FIGURE 110 The potential and the gradient.

The gradient is just a learned term for ‘slope along the steepest direction.’ The gradient is defined for any point on a slope, is large for a steep one and small for a shallow one. The gradient points in the direction of steepest ascent, as shown in Figure 110. The gradient is abbreviated  $\nabla$ , pronounced ‘nabla’, and is mathematically defined through the relation  $\nabla\phi = (\partial\phi/\partial x, \partial\phi/\partial y, \partial\phi/\partial z) = \text{grad } \phi$ . The minus sign in (39) is introduced by convention, in order to have higher potential values at larger heights.\* In everyday life, when the spherical shape of the Earth can be neglected, the gravitational potential is given by

$$\phi = gh . \tag{40}$$

The potential  $\phi$  is an interesting quantity; with a single number at every position in space we can describe the vector aspects of gravitational acceleration. It automatically gives that gravity in New Zealand acts in the opposite direction to gravity in Paris. In addition, the

\* In two or more dimensions slopes are written  $\partial\phi/\partial z$  – where  $\partial$  is still pronounced ‘d’ – because in those cases the expression  $d\phi/dz$  has a slightly different meaning. The details lie outside the scope of this walk.

potential suggests the introduction of the so-called *potential energy*  $U$  by setting

$$U = m\varphi \quad (41)$$

and thus allowing us to determine the change of *kinetic energy*  $T$  of a body falling from a point 1 to a point 2 via

$$T_1 - T_2 = U_2 - U_1 \quad \text{or} \quad \frac{1}{2}m_1\mathbf{v}_1^2 - \frac{1}{2}m_2\mathbf{v}_2^2 = m\varphi_2 - m\varphi_1. \quad (42)$$

In other words, the total energy, defined as the sum of kinetic and potential energy, is *conserved* in motion due to gravity. This is a characteristic property of gravitation. Not all accelerations can be derived from a potential; systems with this property are called *conservative*. The accelerations due to friction are not conservative, but accelerations due to electromagnetism are. In short, we can either say that gravity can be described by a potential, or say that it conserves energy and momentum. When the spherical shape of the Earth can be neglected, the potential energy of an object at height  $h$  is given by

$$U = mgh. \quad (43)$$

To get a feeling of how much energy this is, answer the following question. A car with mass 1 Mg falls down a cliff of 100 m. How much water can be heated from freezing point to boiling point with the energy of the car?

Challenge 281 ny

### THE SHAPE OF THE EARTH

Challenge 282 e For a point-like or a spherical body of mass  $M$ , the potential  $\varphi$  is

$$\varphi = -G \frac{M}{r}. \quad (44)$$

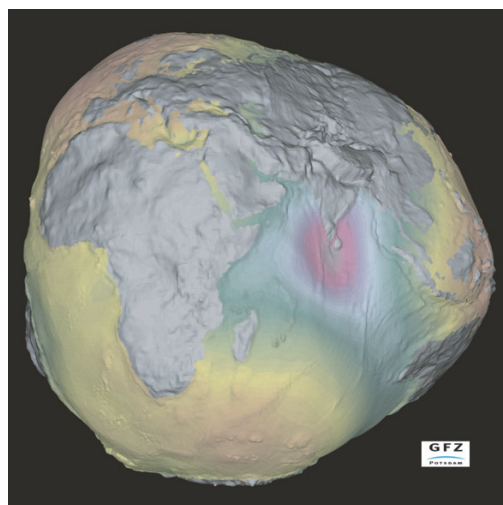
A potential considerably simplifies the description of motion, since a potential is additive: given the potential of a point particle, we can calculate the potential and then the motion around any other irregularly shaped object.\* Interestingly, the number of dimensions of space  $d$  is coded into the potential  $\varphi$  of a spherical mass: the dependence of  $\varphi$  on

\* Alternatively, for a general, extended body, the potential is found by requiring that the *divergence* of its gradient is given by the mass (or charge) density times some proportionality constant. More precisely, one has

$$\Delta\varphi = 4\pi G\rho \quad (45)$$

where  $\rho = \rho(\mathbf{x}, t)$  is the mass volume density of the body and the operator  $\Delta$ , pronounced 'delta', is defined as  $\Delta f = \nabla\nabla f = \partial^2 f/\partial x^2 + \partial^2 f/\partial y^2 + \partial^2 f/\partial z^2$ . Equation (45) is called the *Poisson equation* for the potential  $\varphi$ . It is named after Siméon-Denis Poisson (1781–1840), eminent French mathematician and physicist. The positions at which  $\rho$  is not zero are called the *sources* of the potential. The so-called source term  $\Delta\varphi$  of a function is a measure for how much the function  $\varphi(\mathbf{x})$  at a point  $\mathbf{x}$  differs from the average value in a region around that point. (Can you show this, by showing that  $\Delta\varphi \sim \bar{\varphi} - \varphi(\mathbf{x})$ ?) In other words, the Poisson equation (45) implies that the actual value of the potential at a point is the same as the average value around that point minus the mass density multiplied by  $4\pi G$ . In particular, in the case of empty space the potential at a point is equal to the average of the potential around that point.

Challenge 283 ny



**FIGURE 111** The shape of the Earth, with exaggerated height scale (© GeoForschungsZentrum Potsdam).

Challenge 284 s  
Ref. 126

the radius  $r$  is in fact  $1/r^{d-2}$ . The exponent  $d - 2$  has been checked experimentally to extremely high precision; no deviation of  $d$  from 3 has ever been found.

Ref. 127

The concept of potential helps in understanding the *shape* of the Earth. Since most of the Earth is still liquid when seen on a large scale, its surface is always horizontal with respect to the direction determined by the combination of the accelerations of gravity and rotation. In short, the Earth is *not* a sphere. It is not an ellipsoid either. The mathematical shape defined by the equilibrium requirement is called a *geoid*. The geoid shape differs from a suitably chosen ellipsoid by at most 50 m. Can you describe the geoid mathematically? The geoid is an excellent approximation to the actual shape of the Earth; sea level differs from it by less than 20 metres. The differences can be measured with satellite radar and are of great interest to geologists and geographers. For example, it turns out that the South Pole is nearer to the equatorial plane than the North Pole by about 30 m. This is probably due to the large land masses in the northern hemisphere.

Page 115

Above we saw how the inertia of matter, through the so-called ‘centrifugal force’, increases the radius of the Earth at the Equator. In other words, the Earth is *flattened* at the poles. The Equator has a radius  $a$  of 6.38 Mm, whereas the distance  $b$  from the poles to the centre of the Earth is 6.36 Mm. The precise flattening  $(a - b)/a$  has the value  $1/298.3 = 0.0034$ . As a result, the top of Mount Chimborazo in Ecuador, even though its height is only 6267 m above sea level, is about 20 km farther away from the centre of the Earth than the top of Mount Sagarmatha\* in Nepal, whose height above sea level is 8850 m. The top of Mount Chimborazo is in fact the point on the surface most distant from the centre of the Earth.

Appendix B

As a consequence, if the Earth stopped rotating (but kept its shape), the water of the oceans would flow north; all of Europe would be under water, except for the few mountains of the Alps that are higher than about 4 km. The northern parts of Europe would be

---

Often the concept of *gravitational field* is introduced, defined as  $\mathbf{g} = -\nabla\phi$ . We avoid this in our walk, because we will discover that, following the theory of relativity, gravity is not due to a field at all; in fact even the concept of gravitational potential turns out to be only an approximation.

\* Mount Sagarmatha is sometimes also called Mount Everest.



covered by between 6 km and 10 km of water. Mount Sagarmatha would be over 11 km above sea level. If one takes into account the resulting change of shape of the Earth, the numbers come out smaller. In addition, the change in shape would produce extremely strong earthquakes and storms. As long as there are none of these effects, we can be *sure* that the Sun will indeed rise tomorrow, despite what some philosophers might pretend.

Page 131

### DYNAMICS – HOW DO THINGS MOVE IN VARIOUS DIMENSIONS?

Let us give a short summary. If a body can move only along a (possibly curved) line, the concepts of kinetic and potential energy are sufficient to determine the way it moves. In short, motion in *one dimension* follows directly from energy conservation.

If more than *two spatial dimensions* are involved, energy conservation is insufficient to determine how a body moves. If a body can move in *two dimensions*, and if the forces involved are internal (which is always the case in theory, but not in practice), the conservation of angular momentum can be used. The full motion in two dimensions thus follows from energy and angular momentum conservation. For example, all properties of free fall follow from energy and angular momentum conservation. (Are you able to show this?)

Challenge 286 s

In the case of motion in *three dimensions*, a more general rule for determining motion is necessary. It turns out that all motion follows from a simple principle: the time average of the difference between kinetic and potential energy must be as small as possible. This is called the *least action principle*. We will explain the details of this calculation method later.

Page 199

For simple gravitational motions, motion is two-dimensional, in a plane. Most three-dimensional problems are outside the scope of this text; in fact, some of these problems are still subjects of research. In this adventure, we will explore three-dimensional motion only for selected cases that provide important insights.

### GRAVITATION IN THE SKY

Page 180

The expression for the acceleration due to gravity  $a = GM/r^2$  also describes the motion of all the planets around the Sun. How can we check this? First of all, looking at the sky at night, we can check that the planets always stay within the *zodiac*, a narrow stripe across the sky. The centre line of the zodiac gives the path of the Sun and is called the *ecliptic*, since the Moon must be located on it to produce an eclipse. This shows that planets move (approximately) in a single, common plane.\*

The detailed motion of the planets is not easy to describe. A few generations before Hooke, using the observations of *Tycho Brahe*, the Swabian astronomer Johannes Kepler, in his painstaking research on the movements of the planets in the zodiac, had deduced several 'laws'. The three main ones are as follows:

1. Planets move on ellipses with the Sun located at one focus (1609).
2. Planets sweep out equal areas in equal times (1609).

\* The apparent height of the ecliptic changes with the time of the year and is the reason for the changing seasons. Therefore seasons are a gravitational effect as well.

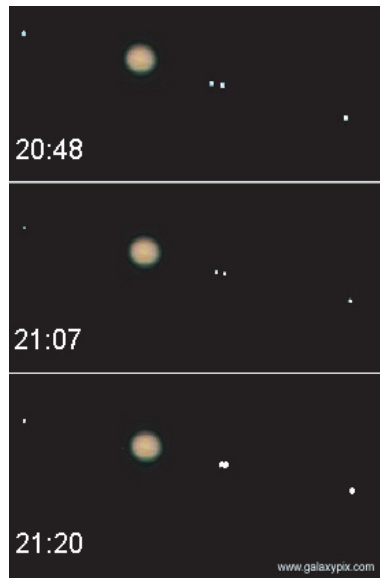


FIGURE 112 The four satellites of Jupiter discovered by Galileo and their motion (© Robin Scagell).

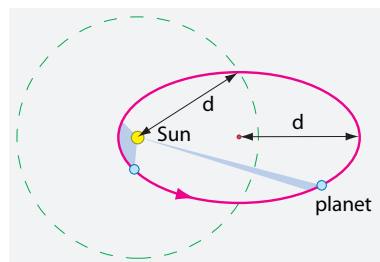


FIGURE 113 The motion of a planet around the Sun, showing its semimajor axis  $d$ , which is also the spatial average of its distance from the Sun.

- All planets have the same ratio  $T^2/d^3$  between the orbit duration  $T$  and the semimajor axis  $d$  (1619).

Kepler's results are illustrated in [Figure 113](#). The sheer work required to deduce the three 'laws' was enormous. Kepler had no calculating machine available. The calculation technology he used was the recently discovered logarithms. Anyone who has used tables of logarithms to perform calculations can get a feeling for the amount of work behind these three discoveries.

Now comes the central point. The huge volume of work by Brahe and Kepler can be summarized in the expression

$$a = GM/r^2, \quad (46)$$

as Hooke and a few others had stated. Let us see why.

[Ref. 129](#) Why is the usual orbit an ellipse? The simplest argument is given in [Figure 114](#). We know that the acceleration due to gravity varies as  $a = GM/r^2$ . We also know that an orbiting body of mass  $m$  has a constant energy  $E < 0$ . We then can draw, around the Sun, the circle with radius  $R = -GMm/E$ , which gives the largest distance that a body with



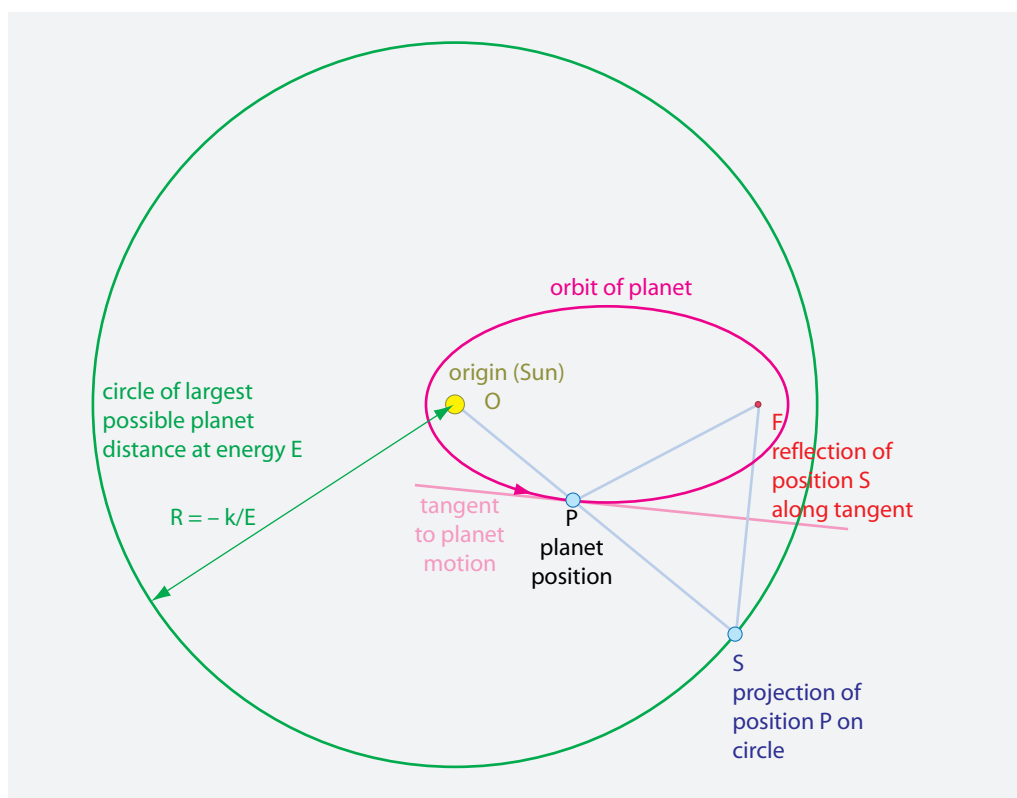


FIGURE 114 The proof that a planet moves in an ellipse (magenta) around the Sun, given an inverse square distance relation for gravitation (see text).

energy  $E$  can be from the Sun. We now project the planet position  $P$  onto this circle, thus constructing a position  $S$ . We then reflect  $S$  along the tangent to get a position  $F$ . This last position  $F$  is constant in time, as a simple argument shows. (Can you find it?) As a result of the construction, the distance sum  $OP + PF$  is constant in time, and given by the radius  $R = -GMm/E$ . Since this distance sum is constant, the orbit is an ellipse, because an ellipse can be drawn with a piece of rope in this way.) Point  $F$ , like the Sun, is a focus of the ellipse. This is the first of Kepler's 'laws'.

Challenge 287 s

Can you confirm that also the other two of Kepler's 'laws' follow from Hooke's expression of universal gravity? Publishing this result was the main achievement of Newton. Try to repeat his achievement; it will show you not only the difficulties, but also the possibilities of physics, and the joy that puzzles give.

Challenge 288 s

The second of Kepler's 'laws', about equal swept areas, implies that planets move faster when they are near the Sun. It is a simple way to state the conservation of angular momentum. What does the third 'law' state?

Challenge 289 e

Newton solved these puzzles with geometric drawing – though in quite a complex manner. It is well known that Newton was not able to write down, let alone handle, differential equations at the time he published his results on gravitation. In fact, Newton's notation and calculation methods were poor. (Much poorer than yours!) The English

Ref. 26



**FIGURE 115** The change of the moon during the month, showing its libration (QuickTime film © Martin Elsässer)

mathematician Godfrey Hardy\* used to say that the insistence on using Newton's integral and differential notation, rather than the earlier and better method, still common today, due to his rival Leibniz – threw back English mathematics by 100 years.

To sum up, Kepler, Hooke and Newton became famous because they brought order to the description of planetary motion. They showed that all motion due to gravity follows from the same description, the inverse square distance. For this reason, the inverse square distance relation  $a = GM/r^2$  is called the *universal* law of gravity. Achieving this unification of motion description, though of small practical significance, was widely publicized. The main reason were the age-old prejudices and fantasies linked with astrology.

In fact, the inverse square distance relation explains many additional phenomena. It explains the motion and shape of the Milky Way and of the other galaxies, the motion of many weather phenomena, and explains why the Earth has an atmosphere but the Moon does not. (Can you explain this?) In fact, universal gravity explains much more about the Moon.

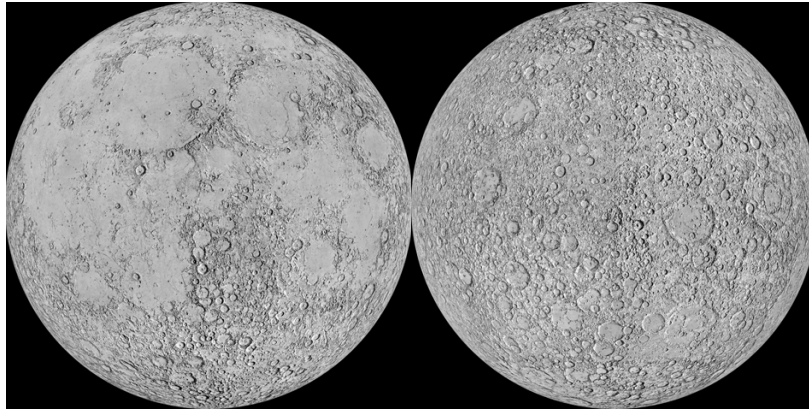
Challenge 290 s

### THE MOON

How long is a day on the Moon? The answer is roughly 29 Earth-days. That is the time that it takes for an observer on the Moon to see the Sun again in the same position in the sky.

One often hears that the Moon always shows the same side to the Earth. But this is wrong. As one can check with the naked eye, a given feature in the centre of the face of the Moon at full Moon is not at the centre one week later. The various motions leading to this change are called *librations*; they are shown in the film in [Figure 115](#). The motions appear mainly because the Moon does not describe a circular, but an elliptical orbit around the Earth and because the axis of the Moon is slightly inclined, compared with

\* Godfrey Harold Hardy (1877–1947) was an important English number theorist, and the author of the well-known *A Mathematician's Apology*. He also 'discovered' the famous Indian mathematician Srinivasa Ramanujan, and brought him to Britain.



**FIGURE 116** High resolution maps (not photographs) of the near side (left) and far side (right) of the moon, showing how often the latter saved the Earth from meteorite impacts (courtesy USGS).

that of its rotation around the Earth. As a result, only around 45 % of the Moon's surface is permanently hidden from Earth.

Challenge 291 e

The first photographs of the hidden area were taken in the 1960s by a Soviet artificial satellite; modern satellites provided exact maps, as shown in [Figure 116](#). (Just zoom into the figure for fun.) The hidden surface is much more irregular than the visible one, as the hidden side is the one that intercepts most asteroids attracted by the Earth. Thus the gravitation of the Moon helps to deflect asteroids from the Earth. The number of animal life extinctions is thus reduced to a small, but not negligible number. In other words, the gravitational attraction of the Moon has saved the human race from extinction many times over.\*

Ref. 130

Ref. 131

Challenge 292 s

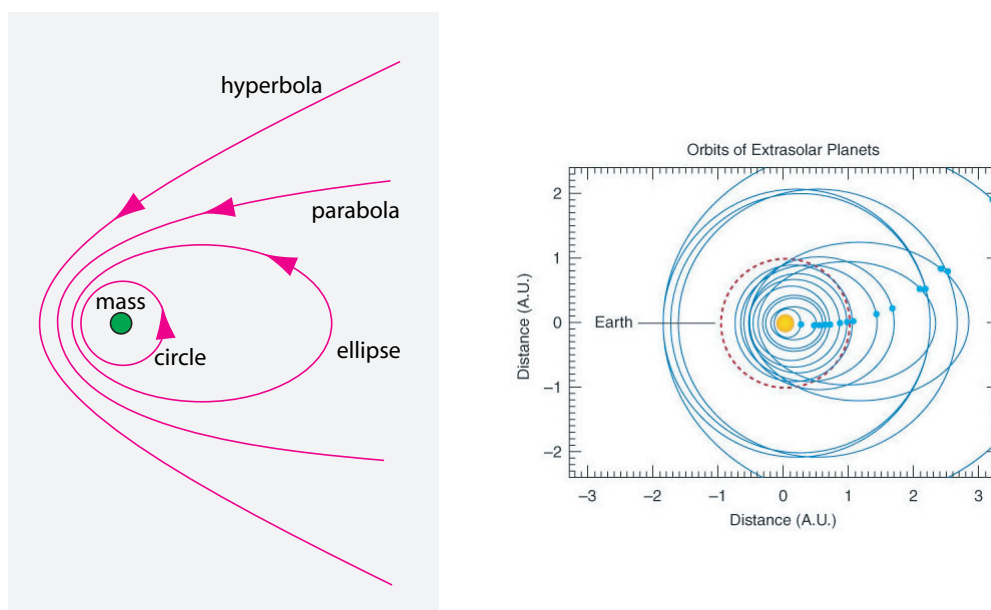
The trips to the Moon in the 1970s also showed that the Moon originated from the Earth itself: long ago, an object hit the Earth almost tangentially and threw a sizeable fraction of material up into the sky. This is the only mechanism able to explain the large size of the Moon, its low iron content, as well as its general material composition.

The Moon is receding from the Earth at 3.8 cm a year. This result confirms the old deduction that the tides slow down the Earth's rotation. Can you imagine how this measurement was performed? Since the Moon slows down the Earth, the Earth also changes shape due to this effect. (Remember that the shape of the Earth depends on its speed of rotation.) These changes in shape influence the tectonic activity of the Earth, and maybe also the drift of the continents.

Ref. 132

The Moon has many effects on animal life. A famous example is the midge *Clunio*, which lives on coasts with pronounced tides. *Clunio* spends between six and twelve weeks as a larva, sure then hatches and lives for only one or two hours as an adult flying insect, during which time it reproduces. The midges will only reproduce if they hatch during the low tide phase of a spring tide. Spring tides are the especially strong tides during the full and new moons, when the solar and lunar effects combine, and occur only every 14.8 days. In 1995, Dietrich Neumann showed that the larvae have two built-in clocks, a circadian and a circalunar one, which together control the hatching to precisely those

\* The web pages [cfa-www.harvard.edu/iau/lists/Closest.html](http://cfa-www.harvard.edu/iau/lists/Closest.html) and [InnerPlot.html](#) give an impression of the number of objects that almost hit the Earth every year. Without the Moon, we would have many additional catastrophes.



**FIGURE 117** The possible orbits due to universal gravity around a large mass (left) and a few recent examples of measured orbits (right), namely those of some extrasolar planets and of the Earth, all drawn around their respective central star, with distances given in astronomical units (© Geoffrey Marcy).

few hours when the insect can reproduce. He also showed that the circalunar clock is synchronized by the brightness of the Moon at night. In other words, the larvae monitor the Moon at night and then decide when to hatch: they are the smallest known astronomers.

If insects can have circalunar cycles, it should come as no surprise that women also have such a cycle; however, in this case the precise origin of the cycle length is still unknown and a topic of research.

Ref. 133

The Moon also helps to stabilize the tilt of the Earth's axis, keeping it more or less fixed relative to the plane of motion around the Sun. Without the Moon, the axis would change its direction irregularly, we would not have a regular day and night rhythm, we would have extremely large climate changes, and the evolution of life would have been impossible. Without the Moon, the Earth would also rotate much faster and we would have much less clement weather. The Moon's main remaining effect on the Earth, the precession of its axis, is responsible for the ice ages.

Ref. 134

Ref. 135

Page 122

### ORBITS – AND CONIC SECTIONS

The path of a body continuously orbiting another under the influence of gravity is an *ellipse* with the central body at one focus. A circular orbit is also possible, a circle being a special case of an ellipse. Single encounters of two objects can also be *parabolas* or *hyperbolas*, as shown in [Figure 117](#). Circles, ellipses, parabolas and hyperbolas are collectively known as *conic sections*. Indeed each of these curves can be produced by cutting a cone with a knife. Are you able to confirm this?

Challenge 293 e

If orbits are mostly ellipses, it follows that comets return. The English astronomer Edmund Halley (1656–1742) was the first to draw this conclusion and to predict the return



**FIGURE 118** The phases of the Moon and of Venus, as observed from Athens in summer 2007 (© Anthony Ayiomamitis).

of a comet. It arrived at the predicted date in 1756, and is now named after him. The period of Halley's comet is between 74 and 80 years; the first recorded sighting was 22 centuries ago, and it has been seen at every one of its 30 passages since, the last time in 1986.

Depending on the initial energy and the initial angular momentum of the body with respect to the central planet, paths are either *elliptic*, *parabolic* or *hyperbolic*. Can you determine the conditions of the energy and the angular momentum needed for these paths to appear?

Challenge 294 ny

In practice, parabolic paths do not exist in nature. (Though some comets seem to approach this case when moving around the Sun; almost all comets follow elliptical paths). Hyperbolic paths do exist; artificial satellites follow them when they are shot towards a planet, usually with the aim of changing the direction of the satellite's journey across the solar system.

Why does the inverse square 'law' lead to conic sections? First, for two bodies, the total angular momentum  $L$  is a constant:

$$L = mr^2\dot{\varphi} \quad (47)$$

and therefore the motion lies in a plane. Also the energy  $E$  is a constant

$$E = \frac{1}{2}m\left(\frac{dr}{dt}\right)^2 + \frac{1}{2}m\left(r\frac{d\varphi}{dt}\right)^2 - G\frac{mM}{r}. \quad (48)$$

Challenge 295 ny Together, the two equations imply that

$$r = \frac{L^2}{Gm^2M} \frac{1}{1 + \sqrt{1 + \frac{2EL^2}{G^2m^3M^2}} \cos \varphi}. \quad (49)$$

Now, any curve defined by the general expression

$$r = \frac{C}{1 + e \cos \varphi} \quad \text{or} \quad r = \frac{C}{1 - e \cos \varphi} \quad (50)$$

is an ellipse for  $0 < e < 1$ , a parabola for  $e = 1$  and a hyperbola for  $e > 1$ , one focus being at the origin. The quantity  $e$ , called the *eccentricity*, describes how squeezed the curve is. In other words, a body in orbit around a central mass follows a conic section.

In all orbits, also the heavy mass moves. In fact, both bodies orbit around the common centre of mass. Both bodies follow the same type of curve (ellipsis, parabola or hyperbola), but the sizes of the two curves differ.

Challenge 296 e

If more than two objects move under mutual gravitation, many additional possibilities for motions appear. The classification and the motions are quite complex. In fact, this so-called *many-body problem* is still a topic of research, and the results are mathematically fascinating. Let us look at a few examples.

When several planets circle a star, they also attract each other. Planets thus do not move in perfect ellipses. The largest deviation is a perihelion shift, as shown in [Figure 93](#). It is observed for Mercury and a few other planets, including the Earth. Other deviations from elliptical paths appear during a single orbit. In 1846, the observed deviations of the motion of the planet Uranus from the path predicted by universal gravity were used to predict the existence of another planet, Neptune, which was discovered shortly afterwards.

Page 92

We have seen that mass is always positive and that gravitation is thus always attractive; there is no *antigravity*. Can gravity be used for *levitation* nevertheless, maybe using more than two bodies? Yes; there are two examples.\* The first are the geostationary satellites, which are used for easy transmission of television and other signals from and towards Earth.

Challenge 297 s

The *Lagrangian libration points* are the second example. Named after their discoverer, these are points in space near a two-body system, such as Moon–Earth or Earth–Sun, in which small objects have a stable equilibrium position. An overview is given in [Figure 119](#). Can you find their precise position, remembering to take rotation into account? There are three additional Lagrangian points on the Earth–Moon line (or Sun–planet line). How many of them are stable?

Challenge 298 d

There are thousands of asteroids, called *Trojan asteroids*, at and around the Lagrangian points of the Sun–Jupiter system. In 1990, a Trojan asteroid for the Mars–Sun system was discovered. Finally, in 1997, an ‘almost Trojan’ asteroid was found that follows the Earth on its way around the Sun (it is only transitional and follows a somewhat more complex orbit). This ‘second companion’ of the Earth has a diameter of 5 km. Similarly, on the main Lagrangian points of the Earth–Moon system a high concentration of dust has been observed.

Ref. 136

To sum up, the single equation  $\mathbf{a} = -GM\mathbf{r}/r^3$  correctly describes a large number of phenomena in the sky. The first person to make clear that this expression describes *everything* happening in the sky was Pierre Simon Laplace\*\* in his famous treatise *Traité*

Vol. III, page 153

\* Levitation is discussed in detail in the section on electrodynamics.

\*\* Pierre Simon Laplace (b. 1749 Beaumont-en-Auge, d. 1827 Paris), important French mathematician. His



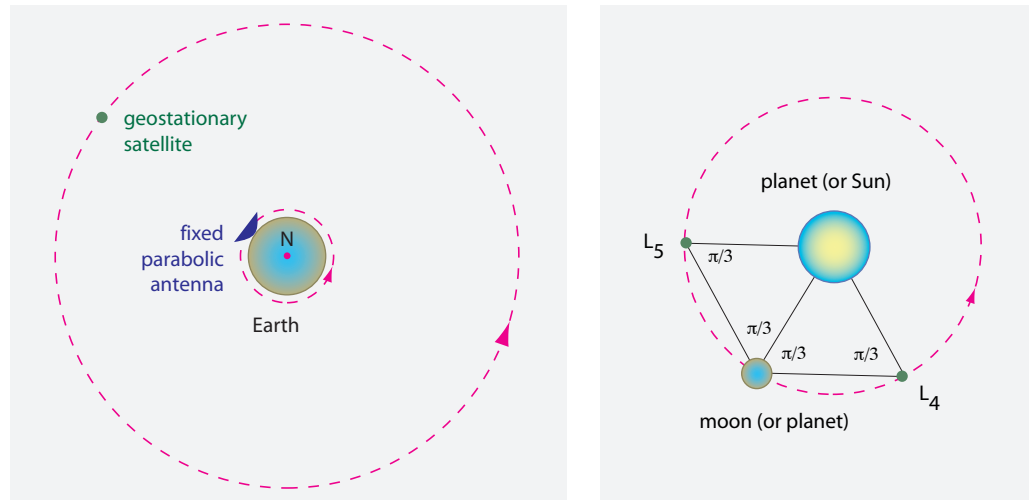


FIGURE 119 Geostationary satellites (left) and the main stable Lagrangian points (right).

*de mécanique céleste*. When Napoleon told him that he found no mention about the creator in the book, Laplace gave a famous, one sentence summary of his book: *Je n'ai pas eu besoin de cette hypothèse*. 'I had no need for this hypothesis.' In particular, Laplace studied the stability of the solar system, the eccentricity of the lunar orbit, and the eccentricities of the planetary orbits, always getting full agreement between calculation and measurement.

These results are quite a feat for the simple expression of universal gravitation; they also explain why it is called 'universal'. But how precise is the formula? Since astronomy allows the most precise measurements of gravitational motion, it also provides the most stringent tests. In 1849, Urbain Le Verrier concluded after intensive study that there was only one known example of a discrepancy between observation and universal gravity, namely one observation for the planet Mercury. (Nowadays a few more are known.) The point of least distance to the Sun of the orbit of planet Mercury, its *perihelion*, changes at a rate that is slightly less than that predicted: he found a tiny difference, around 38'' per century. (This was corrected to 43'' per century in 1882 by Simon Newcomb.) Le Verrier thought that the difference was due to a planet between Mercury and the Sun, *Vulcan*, which he chased for many years without success. Indeed, Vulcan does not exist. The correct explanation of the difference had to wait for Albert Einstein.

Ref. 137

Vol. II, page 161

### TIDES

Ref. 138

Why do physics texts always talk about tides? Because, as general relativity will show, tides prove that space is curved! It is thus useful to study them in a bit more detail. Gravitation explains the sea tides as results of the attraction of the ocean water by the Moon and the Sun. Tides are interesting; even though the amplitude of the tides is only about 0.5 m on the open sea, it can be up to 20 m at special places near the coast. Can you imagine why? The *soil* is also lifted and lowered by the Sun and the Moon, by about 0.3 m, as

Challenge 299 s

treatise appeared in five volumes between 1798 and 1825. He was the first to propose that the solar system was formed from a rotating gas cloud, and one of the first people to imagine and explore black holes.





FIGURE 120 Tides at Saint-Valéry en Caux on September 20, 2005 (© Gilles Régner).

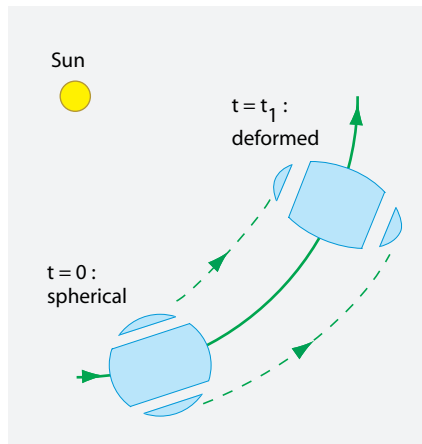


FIGURE 121 Tidal deformations due to gravity.

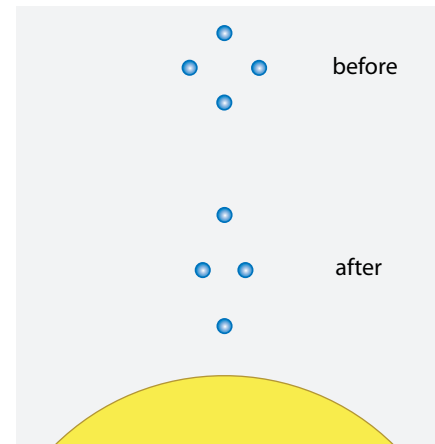


FIGURE 122 The origin of tides.

Ref. 50 satellite measurements show. Even the *atmosphere* is subject to tides, and the corresponding pressure variations can be filtered out from the weather pressure measurements.  
Ref. 139

Tides appear for any *extended* body moving in the gravitational field of another. To understand the origin of tides, picture a body in orbit, like the Earth, and imagine its components, such as the segments of Figure 121, as being held together by springs. Universal gravity implies that orbits are slower the more distant they are from a central body. As a result, the segment on the outside of the orbit would like to be slower than the central one; but it is *pulled* by the rest of the body through the springs. In contrast, the inside segment would like to orbit more rapidly but is *retained* by the others. Being slowed down, the inside segments want to fall towards the Sun. In sum, both segments feel a pull away from the centre of the body, limited by the springs that stop the deformation. Therefore, *extended bodies are deformed in the direction of the field inhomogeneity*.

For example, as a result of tidal forces, the Moon always has (roughly) the same face to the Earth. In addition, its radius in direction of the Earth is larger by about 5 m than the radius perpendicular to it. If the inner springs are too weak, the body is torn into pieces; in this way a *ring* of fragments can form, such as the asteroid ring between Mars and Jupiter or the rings around Saturn.

Let us return to the Earth. If a body is surrounded by water, it will form bulges in the direction of the applied gravitational field. In order to measure and compare the strength of the tides from the Sun and the Moon, we reduce tidal effects to their bare minimum. As shown in [Figure 122](#), we can study the deformation of a body due to gravity by studying the deformation of four pieces. We can study it in free fall, because orbital motion and free fall are equivalent. Now, gravity makes some of the pieces approach and others diverge, depending on their relative positions. The figure makes clear that the strength of the deformation – water has no built-in springs – depends on the change of gravitational acceleration with distance; in other words, the *relative* acceleration that leads to the tides is proportional to the derivative of the gravitational acceleration.

Using the numbers from [Appendix B](#), the gravitational accelerations from the Sun and the Moon measured on Earth are

$$\begin{aligned} a_{\text{Sun}} &= \frac{GM_{\text{Sun}}}{d_{\text{Sun}}^2} = 5.9 \text{ mm/s}^2 \\ a_{\text{Moon}} &= \frac{GM_{\text{Moon}}}{d_{\text{Moon}}^2} = 0.033 \text{ mm/s}^2 \end{aligned} \quad (51)$$

and thus the attraction from the Moon is about 178 times weaker than that from the Sun.

When two nearby bodies fall near a large mass, the relative acceleration is proportional to their distance, and follows  $da = da/dr dr$ . The proportionality factor  $da/dr = \nabla a$ , called the *tidal acceleration* (gradient), is the true measure of tidal effects. Near a large spherical mass  $M$ , it is given by

Challenge 300 e

$$\frac{da}{dr} = -\frac{2GM}{r^3} \quad (52)$$

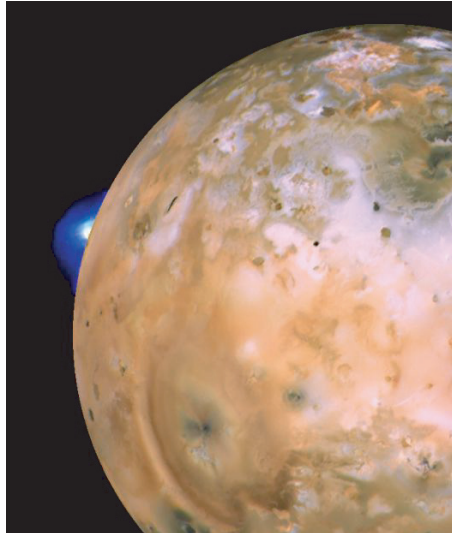
which yields the values

$$\begin{aligned} \frac{da_{\text{Sun}}}{dr} &= -\frac{2GM_{\text{Sun}}}{d_{\text{Sun}}^3} = -0.8 \cdot 10^{-13} / \text{s}^2 \\ \frac{da_{\text{Moon}}}{dr} &= -\frac{2GM_{\text{Moon}}}{d_{\text{Moon}}^3} = -1.7 \cdot 10^{-13} / \text{s}^2 . \end{aligned} \quad (53)$$

In other words, despite the much weaker pull of the Moon, its tides are predicted to be over *twice as strong* as the tides from the Sun; this is indeed observed. When Sun, Moon and Earth are aligned, the two tides add up; these so-called *spring tides* are especially strong and happen every 14.8 days, at full and new moon.

Tides lead to a pretty puzzle. Moon tides are much stronger than Sun tides. This implies that the Moon is much denser than the Sun. Why?

Challenge 301 s



**FIGURE 123** A spectacular result of tides: volcanism on Io (NASA).

Ref. 100  
Vol. II, page 208

Challenge 302 s

Tides also produce *friction*. The friction leads to a slowing of the Earth's rotation. Nowadays, the slowdown can be measured by precise clocks (even though short time variations due to other effects, such as the weather, are often larger). The results fit well with fossil results showing that 400 million years ago, in the Devonian period, a year had 400 days, and a day about 22 hours. It is also estimated that 900 million years ago, each of the 481 days of a year were 18.2 hours long. The friction at the basis of this slowdown also results in an increase in the distance of the Moon from the Earth by about 3.8 cm per year. Are you able to explain why?

As mentioned above, the tidal motion of the soil is also responsible for the triggering of *earthquakes*. Thus the Moon can have also dangerous effects on Earth. (Unfortunately, knowing the mechanism does not allow the prediction of earthquakes.) The most fascinating example of tidal effects is seen on Jupiter's satellite Io. Its tides are so strong that they induce intense volcanic activity, as shown in [Figure 123](#), with eruption plumes as high as 500 km. If tides are even stronger, they can destroy the body altogether, as happened to the body between Mars and Jupiter that formed the planetoids, or (possibly) to the moons that led to Saturn's rings.

Vol. II, page 122

Vol. II, page 172

In summary, tides are due to relative accelerations of nearby mass points. This has an important consequence. In the chapter on general relativity we will find that time multiplied by the speed of light plays the same role as length. Time then becomes an additional dimension, as shown in [Figure 124](#). Using this similarity, two free particles moving in the same direction correspond to parallel lines in space-time. Two particles falling side-by-side also correspond to parallel lines. Tides show that such particles approach each other. In other words, tides imply that parallel lines approach each other. But parallel lines can approach each other *only* if space-time is curved. In short, tides imply *curved* space-time and space. This simple reasoning could have been performed in the eighteenth century; however, it took another 200 years and Albert Einstein's genius to uncover it.

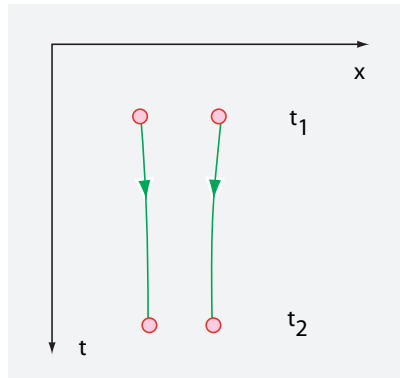


FIGURE 124 Particles falling side-by-side approach over time.

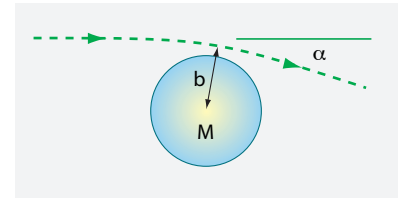


FIGURE 125 Masses bend light.

### CAN LIGHT FALL?

“Die Maxime, jederzeit selbst zu denken, ist die Aufklärung.”  
Immanuel Kant\*

Vol. II, page 14

Towards the end of the seventeenth century people discovered that light has a finite velocity – a story which we will tell in detail later. An entity that moves with infinite velocity cannot be affected by gravity, as there is no time to produce an effect. An entity with a finite speed, however, should feel gravity and thus fall.

Ref. 140

Does its speed increase when light reaches the surface of the Earth? For almost three centuries people had no means of detecting any such effect; so the question was not investigated. Then, in 1801, the Prussian astronomer Johann Soldner (1776–1833) was the first to put the question in a different way. Being an astronomer, he was used to measuring stars and their observation angles. He realized that light passing near a massive body would be *deflected* due to gravity.

Challenge 303 ny

Soldner studied a body on a hyperbolic path, moving with velocity  $c$  past a spherical mass  $M$  at distance  $b$  (measured from the centre), as shown in Figure 125. Soldner deduced the deflection angle

$$\alpha_{\text{univ. grav.}} = \frac{2}{b} \frac{GM}{c^2}. \quad (54)$$

Vol. II, page 159

One sees that the angle is largest when the motion is just grazing the mass  $M$ . For light deflected by the mass of the Sun, the angle turns out to be at most a tiny  $0.88'' = 4.3 \mu\text{rad}$ . In Soldner's time, this angle was too small to be measured. Thus the issue was forgotten. Had it been pursued, general relativity would have begun as an experimental science, and not as the theoretical effort of Albert Einstein! Why? The value just calculated is *different* from the measured value. The first measurement took place in 1919;\*\* it found the correct dependence on the distance, but found a deflection of up to  $1.75''$ , exactly double that of expression (54). The reason is not easy to find; in fact, it is due to the curvature of space,

\* The maxim to think at all times for oneself is the enlightenment.

Challenge 304 ny

\*\* By the way, how would you measure the deflection of light near the bright Sun?

as we will see. In summary, light can fall, but the issue hides some surprises.

### WHAT IS MASS? – AGAIN

Mass describes how an object interacts with others. In our walk, we have encountered two of its aspects. *Inertial mass* is the property that keeps objects moving and that offers resistance to a change in their motion. *Gravitational mass* is the property responsible for the acceleration of bodies nearby (the active aspect) or of being accelerated by objects nearby (the passive aspect). For example, the active aspect of the mass of the Earth determines the surface acceleration of bodies; the passive aspect of the bodies allows us to weigh them in order to measure their mass using distances only, e.g. on a scale or a balance. The gravitational mass is the basis of *weight*, the difficulty of lifting things.\*

Is the gravitational mass of a body equal to its inertial mass? A rough answer is given by the experience that an object that is difficult to move is also difficult to lift. The simplest experiment is to take two bodies of different masses and let them fall. If the acceleration is the same for all bodies, inertial mass is equal to (passive) gravitational mass, because in the relation  $ma = \nabla(GMm/r)$  the left-hand  $m$  is actually the inertial mass, and the right-hand  $m$  is actually the gravitational mass.

But in the seventeenth century Galileo had made widely known an even older argument showing without a single experiment that the acceleration is indeed the same for all bodies. If larger masses fell more rapidly than smaller ones, then the following paradox would appear. Any body can be seen as being composed of a large fragment attached to a small fragment. If small bodies really fell less rapidly, the small fragment would slow the large fragment down, so that the complete body would have to fall *less* rapidly than the larger fragment (or break into pieces). At the same time, the body being larger than its fragment, it should fall *more* rapidly than that fragment. This is obviously impossible: all masses must fall with the same acceleration.

Many accurate experiments have been performed since Galileo's original discussion. In all of them the independence of the acceleration of free fall from mass and material composition has been confirmed with the precision they allowed. In other words, as far as we can tell, gravitational mass and inertial mass are *identical*. What is the origin of this mysterious equality?

This so-called 'mystery' is a typical example of disinformation, now common across the whole world of physics education. Let us go back to the definition of mass as a negative inverse acceleration ratio. We mentioned that the physical origins of the accelerations do not play a role in the definition because the origin does not appear in the expression. In other words, the value of the mass is by definition independent of the interaction. That means in particular that inertial mass, based on electromagnetic interaction, and gravitational mass are identical *by definition*.

We also note that we have never defined a separate concept of 'passive gravitational mass'. The mass being accelerated by gravitation is the inertial mass. Worse, there is no way to define a 'passive gravitational mass'. Try it! All methods, such as weighing an object, cannot be distinguished from those that determine inertial mass from its reaction to acceleration. Indeed, all methods of measuring mass use non-gravitational mechanisms. Scales are a good example.

Challenge 305 ny

\* What are the values shown by a balance for a person of 85 kg juggling three balls of 0.3 kg each?

If the ‘passive gravitational mass’ were different from the inertial mass, we would have strange consequences. For those bodies for which it were different we would get into trouble with energy conservation. Also assuming that ‘active gravitational mass’ differs from inertial mass gets us into trouble.

Another way of looking at the issue is as follows. How could ‘gravitational mass’ differ from inertial mass? Would the difference depend on relative velocity, time, position, composition or on mass itself? Each of these possibilities contradicts either energy or momentum conservation.

Vol. II, page 142

No wonder that all measurements confirm the equality of all mass types. The issue is usually resurrected in general relativity, with no new results. ‘Both’ masses remain equal; mass is a unique property of bodies. Another issue remains, though. What is the *origin* of mass? Why does it exist? This simple but deep question cannot be answered by classical physics. We will need some patience to find out.

### CURIOSITIES AND FUN CHALLENGES ABOUT GRAVITATION

“Fallen ist weder gefährlich noch eine Schande;  
Liegen bleiben ist beides.\*”  
Konrad Adenauer

Gravity on the Moon is only one sixth of that on the Earth. Why does this imply that it is difficult to walk quickly and to run on the Moon (as can be seen in the TV images recorded there)?

\* \*

It is unknown whether the mass of the Earth increases with time (due to collection of meteorites and cosmic dust) or decreases (due to gas loss). If you find a way to settle the issue, publish it.

\* \*

Challenge 307 s

Several humans have survived free falls from aeroplanes for a thousand metres or more, even though they had no parachute. A minority of them even did so without any harm at all. How was this possible?

\* \*

Challenge 308 e

Imagine that you have twelve coins of identical appearance, of which one is a forgery. The forged one has a different mass from the eleven genuine ones. How can you decide which is the forged one and whether it is lighter or heavier, using a simple balance only three times?

You have nine identically-looking spheres, all of the same mass, except one, which is heavier. Can you determine which one, using the balance only two times?

\* \*

For a physicist, *antigravity* is repulsive gravity; it does not exist in nature. Nevertheless,

\* ‘Falling is neither dangerous nor a shame; to keep lying is both.’ Konrad Adenauer (b. 1876 Köln, d. 1967 Rhöndorf), West German Chancellor.

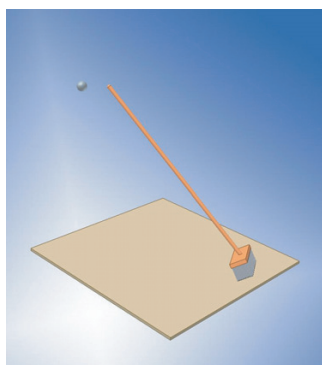


FIGURE 126 Brooms fall more rapidly than stones (© Luca Gastaldi).

the term ‘antigravity’ is used incorrectly by many people, as a short search on the internet shows. Some people call any effect that *overcomes* gravity, ‘antigravity’. However, this definition implies that tables and chairs are antigravity devices. Following the definition, most of the wood, steel and concrete producers are in the antigravity business. The internet definition makes absolutely no sense.

\* \*

Challenge 309 s What is the cheapest way to switch gravity off for 25 seconds?

\* \*

Do all objects on Earth fall with the same acceleration of  $9.8 \text{ m/s}^2$ , assuming that air resistance can be neglected? No; every housekeeper knows that. You can check this by yourself. A broom angled at around  $35^\circ$  hits the floor before a stone, as the sounds of impact confirm. Are you able to explain why?

Challenge 310 s

\* \*

Also bungee jumpers are accelerated more strongly than  $g$ . For a bungee cord of mass  $m$  and a jumper of mass  $M$ , the maximum acceleration  $a$  is

$$a = g \left( 1 + \frac{1}{8} \frac{m}{M} \left( 4 + \frac{m}{M} \right) \right). \quad (55)$$

Challenge 311 s Can you deduce the relation from Figure 127?

\* \*

Challenge 312 s Guess: What is the weight of a ball of cork with a radius of 1 m?

\* \*

Challenge 313 s Guess: One thousand 1 mm diameter steel balls are collected. What is the mass?

\* \*

Challenge 314 s How can you use your observations made during your travels with a bathroom scale to show that the Earth is not flat?



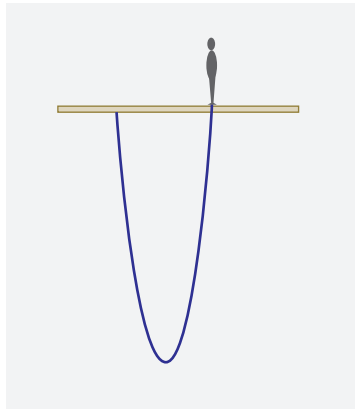


FIGURE 127 The starting situation for a bungee jumper.

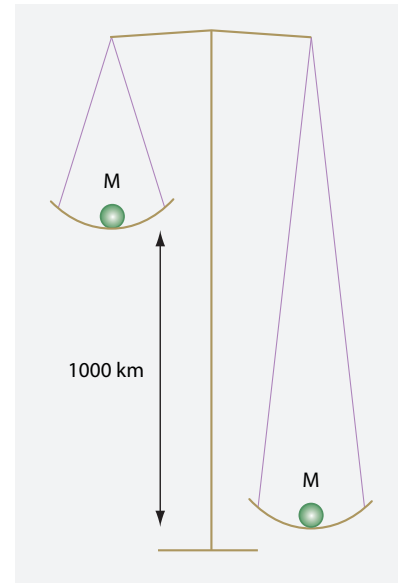


FIGURE 128 An honest balance?

\* \*

Is the acceleration due to gravity constant? Not really. Every day, it is estimated that  $10^8$  kg of material fall onto the Earth in the form of meteorites.

\* \*

Both the Earth and the Moon attract bodies. The centre of mass of the Earth–Moon system is 4800 km away from the centre of the Earth, quite near its surface. Why do bodies on Earth still fall towards the centre of the Earth?

Challenge 315 s

\* \*

Does every spherical body fall with the same acceleration? No. If the weight of the object is comparable to that of the Earth, the distance decreases in a different way. Can you confirm this statement? What then is wrong about Galileo's argument about the constancy of acceleration of free fall?

Challenge 316 ny

\* \*

What is the fastest speed that a human can achieve making use of gravitational acceleration? There are various methods that try this; a few are shown in Figure 129. Terminal speed of free falling skydivers can be even higher, but no reliable record speed value exists. The last word is not spoken yet, as all these records will be surpassed in the coming years. It is important to require normal altitude; at stratospheric altitudes, speed values can be four times the speed values at low altitude.

Vol. II, page 122

\* \*

It is easy to lift a mass of a kilogram from the floor on a table. Twenty kilograms is harder.



**FIGURE 129** Reducing air resistance increases the terminal speed: left, the 2007 speed skiing world record holder Simone Origone with 69.83 m/s and right, the 2007 speed world record holder for bicycles on snow Éric Barone with 61.73 m/s (© Simone Origone, Éric Barone).

**Challenge 317 s** A thousand is impossible. However,  $6 \cdot 10^{24}$  kg is easy. Why?

\* \*

The friction between the Earth and the Moon slows down the rotation of both. The Moon stopped rotating millions of years ago, and the Earth is on its way to doing so as well. When the Earth stops rotating, the Moon will stop moving away from Earth. How far will the Moon be from the Earth at that time? Afterwards however, even further in the future, the Moon will move back towards the Earth, due to the friction between the Earth–Moon system and the Sun. Even though this effect would only take place if the Sun burned for ever, which is known to be false, can you explain it?

Challenge 318 ny

**Challenge 319 s**

\* \*

When you run towards the east, you *lose weight*. There are two different reasons for this: the ‘centrifugal’ acceleration increases so that the force with which you are pulled down diminishes, and the Coriolis force appears, with a similar result. Can you estimate the size of the two effects?

Challenge 320 ny

\* \*

**Challenge 321 s**

What is the relation between the time a stone takes falling through a distance  $l$  and the time a pendulum takes swinging through half a circle of radius  $l$ ? (This problem is due to Galileo.) How many digits of the number  $\pi$  can one expect to determine in this way?

\* \*

Why can a spacecraft accelerate through the *slingshot effect* when going round a planet,



**FIGURE 130** The man in orbit feels no weight, the blue atmosphere, which is not, does (NASA).

**Challenge 322 s** despite momentum conservation? It is speculated that the same effect is also the reason for the few exceptionally fast stars that are observed in the galaxy. For example, the star HE0457-5439 moves with 720 km/s, which is much higher than the 100 to 200 km/s of most stars in the Milky way. It seems that the role of the accelerating centre was taken by a black hole.

Ref. 142

\* \*

**Ref. 143** The orbit of a planet around the Sun has many interesting properties. What is the hodo-  
**Challenge 323 s** graph of the orbit? What is the hodograph for parabolic and hyperbolic orbits?

\* \*

The *Galilean satellites* of Jupiter, shown in **Figure 112** on **page 153**, can be seen with small amateur telescopes. Galileo discovered them in 1610 and called them the *Medicean satellites*. (Today, they are named, in order of increasing distance from Jupiter, as Io, Europa, Ganymede and Callisto.) They are almost mythical objects. They were the first bodies found that obviously did not orbit the Earth; thus Galileo used them to deduce that the Earth is not at the centre of the universe. The satellites have also been candidates to be the first *standard clock*, as their motion can be predicted to high accuracy, so that the 'standard time' could be read off from their position. Finally, due to this high accuracy, in 1676, the speed of light was first measured with their help, as told in the section on special relativity.

Vol. II, page 15

\* \*

**Challenge 324 s** A simple, but difficult question: if all bodies attract each other, why don't or didn't all stars fall towards each other? Indeed, the inverse square expression of universal gravity has a limitation: it does not allow one to make sensible statements about the matter in the

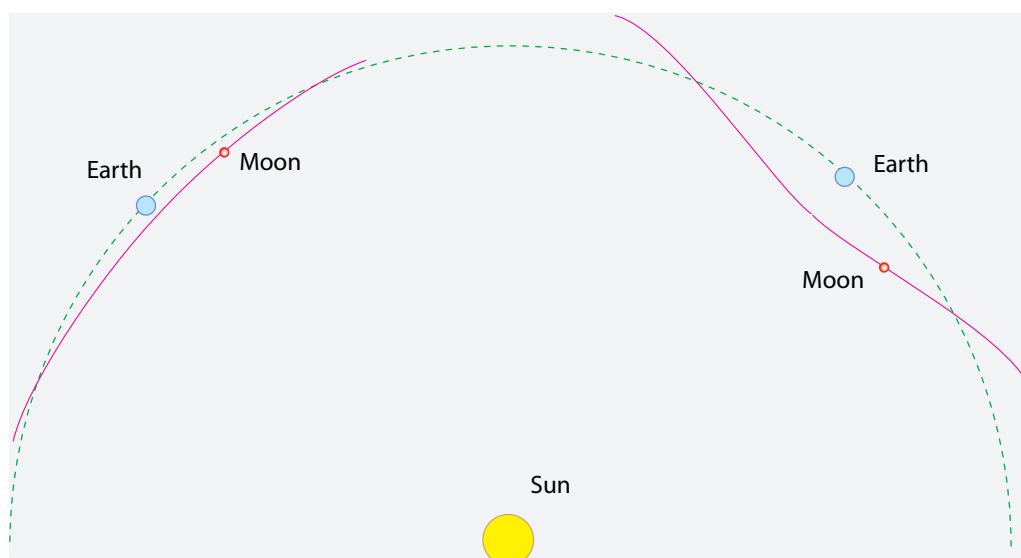


FIGURE 131 Which of the two Moon paths is correct?

universe. Universal gravity predicts that a homogeneous mass distribution is unstable; indeed, an inhomogeneous distribution is observed. However, universal gravity does not predict the average mass density, the darkness at night, the observed speeds of the distant galaxies, etc. In fact, 'universal' gravity does not explain or predict a single property of the universe. To do this, we need general relativity.

Vol. II, page 192

\* \*

The acceleration  $g$  due to gravity at a depth of 3000 km is  $10.05 \text{ m/s}^2$ , over 2% more than at the surface of the Earth. How is this possible? Also, on the Tibetan plateau,  $g$  is influenced by the material below it.

Ref. 144

\* \*

When the Moon circles the Sun, does its path have sections *concave* towards the Sun, as shown at the right of Figure 131, or not, as shown on the left? (Independent of this issue, both paths in the diagram disguise that the Moon path does *not* lie in the same plane as the path of the Earth around the Sun.)

Challenge 325 s

\* \*

You can prove that objects *attract each other* (and that they are not only attracted by the Earth) with a simple experiment that anybody can perform at home, as described on the [www.fourmilab.ch/gravitation/foobar](http://www.fourmilab.ch/gravitation/foobar) website.

\* \*

It is instructive to calculate the *escape velocity* of the Earth, i.e., that velocity with which a body must be thrown so that it never falls back. It turns out to be 11 km/s. What is the escape velocity for the solar system? By the way, the escape velocity of our galaxy is 129 km/s. What would happen if a planet or a system were so heavy that its escape



**FIGURE 132** The analemma over Delphi, between January and December 2002 (© Anthony Ayiomamitis).

**Challenge 326 s** velocity would be larger than the speed of light?

\* \*

**Challenge 327 s** For bodies of irregular shape, the centre of gravity of a body is *not* the same as the centre of mass. Are you able to confirm this? (Hint: Find and use the simplest example possible.)

\* \*

**Challenge 328 ny** Can gravity produce repulsion? What happens to a small test body on the inside of a large C-shaped mass? Is it pushed towards the centre of mass?

\* \*

**Ref. 145** **Challenge 329 ny** The *shape* of the Earth is not a sphere. As a consequence, a plumb line usually does not point to the centre of the Earth. What is the largest deviation in degrees?

\* \*

**Challenge 330 s** What is the largest asteroid one can escape from by jumping?

\* \*

If you look at the sky every day at 6 a.m., the Sun's position varies during the year. The result of photographing the Sun on the same film is shown in **Figure 132**. The curve, called the analemma, is due to two combined effects: the inclination of the Earth's axis and the elliptical shape of the Earth's orbit around the Sun. The top and the (hidden) bottom points of the analemma correspond to the solstices. How does the analemma look

Challenge 331 s if photographed every day at local noon? Why is it not a straight line pointing exactly south?

\* \*

The constellation in which the Sun stands at noon (at the centre of the time zone) is supposedly called the 'zodiacal sign' of that day. Astrologers say there are twelve of them, namely Aries, Taurus, Gemini, Cancer, Leo, Virgo, Libra, Scorpius, Sagittarius, Capricornus, Aquarius and Pisces and that each takes (quite precisely) a twelfth of a year or a twelfth of the ecliptic. Any check with a calendar shows that at present, the midday Sun is never in the zodiacal sign during the days usually connected to it. The relation has shifted by about a month since it was defined, due to the precession of the Earth's axis.

Page 127 A check with a map of the star sky shows that the twelve constellations do not have the same length and that on the ecliptic there are fourteen of them, not twelve. There is *Ophiuchus*, the snake constellation, between Scorpius and Sagittarius, and *Cetus*, the whale, between Aquarius and Pisces. In fact, not a single astronomical statement about zodiacal signs is correct. To put it clearly, astrology, in contrast to its name, is *not* about stars. (In some languages, the term for 'crook' is derived from the word 'astrologer'.)

Ref. 146

\* \*

Ref. 147 For a long time, it was thought that there is no additional planet in our solar system outside Neptune and Pluto, because their orbits show no disturbances from another body. Today, the view has changed. It is known that there are only eight planets: Pluto is not a planet, but the first of a set of smaller objects in the so-called Kuiper belt. Kuiper belt objects are regularly discovered; around 80 are known today.

Ref. 148 In 2003, two major Kuiper objects were discovered; one, called *Sedna*, is almost as large as Pluto, the other, called *Eris*, is even larger than Pluto and has a moon. Both have strongly elliptical orbits. (Since Pluto and Eris, like the asteroid Ceres, have cleaned their orbit from debris, these three objects are now classified as *dwarf planets*.)

\* \*

Ref. 149 In astronomy new examples of motion are regularly discovered even in the present century. Sometimes there are also false alarms. One example was the alleged fall of *mini comets* on the Earth. They were supposedly made of a few dozen kilograms of ice and hitting the Earth every few seconds. It is now known not to happen. On the other hand, it is known that many tons of asteroids fall on the Earth every day, in the form of tiny particles. Incidentally, discovering objects hitting the Earth is not at all easy. Astronomers like to point out that an asteroid as large as the one that led to the extinction of the dinosaurs could hit the Earth without any astronomer noticing in advance, if the direction is slightly unusual, such as from the south, where few telescopes are located.

\* \*

Challenge 332 s Universal gravity allows only elliptical, parabolic or hyperbolic orbits. It is impossible for a small object approaching a large one to be captured. At least, that is what we have learned so far. Nevertheless, all astronomy books tell stories of capture in our solar system; for example, several outer satellites of Saturn have been captured. How is this possible?



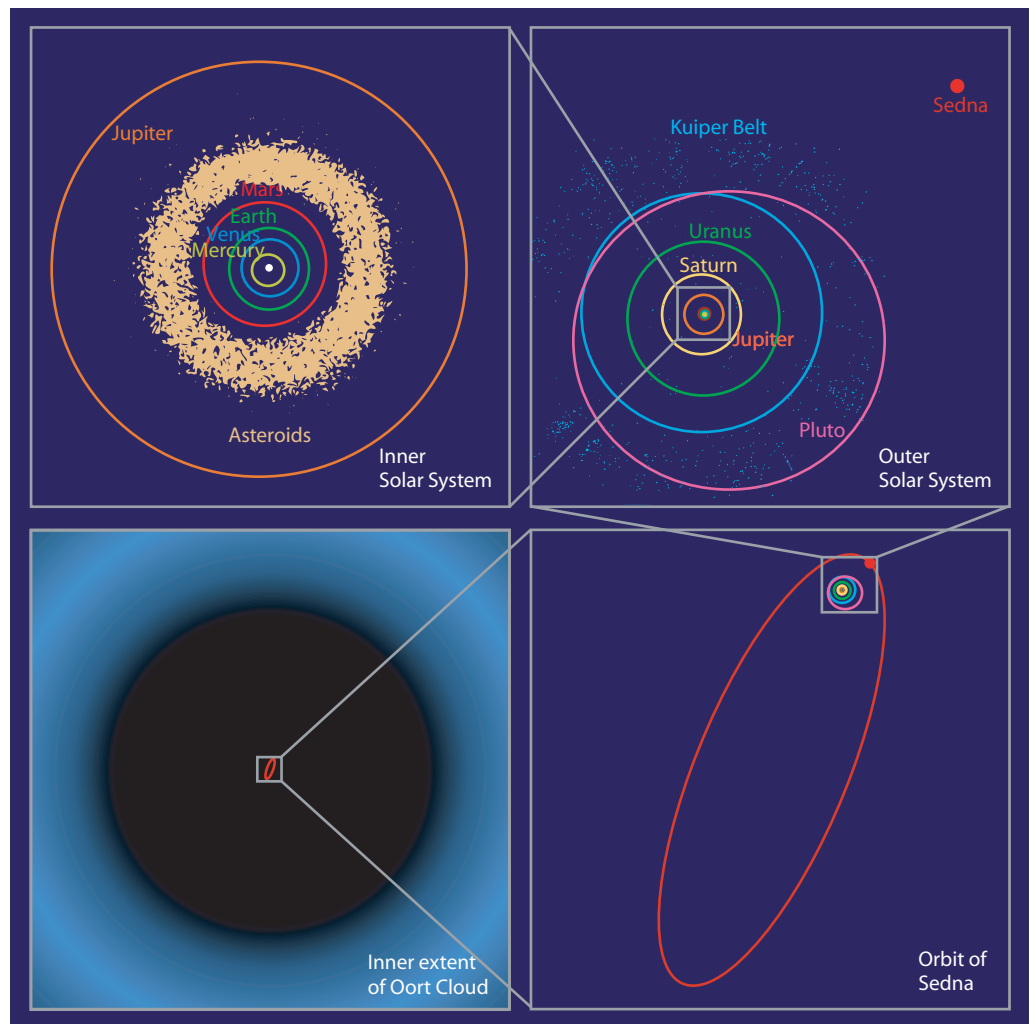


FIGURE 133 The orbit of Sedna in comparison with the orbits of the planets in the solar system (NASA).

\* \*

How would a tunnel have to be shaped in order that a stone would fall through it without touching the walls? (Assume constant density.) If the Earth did not rotate, the tunnel would be a straight line through its centre, and the stone would fall down and up again, in a oscillating motion. For a rotating Earth, the problem is much more difficult. What is the shape when the tunnel starts at the Equator?

Challenge 333 s

\* \*

The International Space Station circles the Earth every 90 minutes at an altitude of about 380 km. You can see where it is from the website [www.heavens-above.com](http://www.heavens-above.com). By the way, whenever it is just above the horizon, the station is the third brightest object in the night sky, superseded only by the Moon and Venus. Have a look at it.

Challenge 334 e



\* \*

Challenge 335 s Vol. II, page 27 Is it true that the centre of mass of the solar system, its barycentre, is always inside the Sun? Even though a star or the Sun move very little when planets move around them, this motion can be detected with precision measurements making use of the Doppler effect for light or radio waves. Jupiter, for example, produces a speed change of 13 m/s in the Sun, the Earth 1 m/s. The first planets outside the solar system, around the pulsar PSR1257+12 and the star Pegasi 51, was discovered in this way, in 1992 and 1995. In the meantime, over 150 planets have been discovered with this method. So far, the smallest planet discovered has 7 times the mass of the Earth.

\* \*

Challenge 336 d Not all points on the Earth receive the same number of daylight hours during a year. The effects are difficult to spot, though. Can you find one?

\* \*

Challenge 337 s Can the phase of the Moon have a measurable effect on the human body, for example through tidal effects?

\* \*

Challenge 338 s There is an important difference between the heliocentric system and the old idea that all planets turn around the Earth. The heliocentric system states that certain planets, such as Mercury and Venus, can be *between* the Earth and the Sun at certain times, and *behind* the Sun at other times. In contrast, the geocentric system states that they are always in between. Why did such an important difference not immediately invalidate the geocentric system?

\* \*

Ref. 150 The strangest reformulation of the description of motion given by  $m\mathbf{a} = \nabla U$  is the almost absurd looking equation

$$\nabla v = d\mathbf{v}/ds \quad (56)$$

Challenge 339 s where  $s$  is the motion path length. It is called the *ray form* of Newton's equation of motion. Can you find an example of its application?

\* \*

Challenge 340 s Seen from Neptune, the size of the Sun is the same as that of Jupiter seen from the Earth at the time of its closest approach. True?

\* \*

Ref. 151 Challenge 341 s The gravitational acceleration for a particle inside a spherical shell is zero. The vanishing of gravity in this case is independent of the particle shape and its position, and independent of the thickness of the shell. Can you find the argument using [Figure 134](#)? This works only because of the  $1/r^2$  dependence of gravity. Can you show that the result does not hold for non-spherical shells? Note that the vanishing of gravity inside a spherical shell usually does not hold if other matter is found outside the shell. How could one eliminate

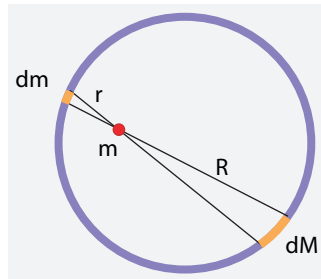


FIGURE 134 The vanishing of gravitational force inside a spherical shell of matter.

Challenge 342 s the effects of outside matter?

\* \*

Ref. 152 What is gravity? This is not a simple question. In 1690, Nicolas Fatio de Duillier and in 1747, Georges-Louis Lesage proposed an explanation for the  $1/r^2$  dependence. Lesage argued that the world is full of small particles – he called them ‘corpuscules ultra-mondains’ – flying around randomly and hitting all objects. Single objects do not feel the hits, since they are hit continuously and randomly from all directions. But when two objects are near to each other, they produce shadows for part of the flux to the other body, resulting in an attraction. Can you show that such an attraction has a  $1/r^2$  dependence?

Challenge 343 ny

However, Lesage’s proposal has a number of problems. The argument only works if the collisions are inelastic. (Why?) However, that would mean that all bodies would heat up with time, as Jean-Marc Lévy-Leblond explains.

Ref. 2

There are two additional problems with the idea of Lesage. First, a moving body in free space would be hit by more or faster particles in the front than in the back; as a result, the body should be decelerated. Second, gravity would depend on size, but in a strange way. In particular, three bodies lying on a line should *not* produce shadows, as no such shadows are observed; but the naive model predicts such shadows.

Despite all the criticisms, this famous idea has regularly resurfaced in physics ever since, even though such particles have never been found. Only in the final part of our mountain ascent will we settle the issue.

\* \*

Challenge 344 ny For which bodies does gravity decrease as you approach them?

\* \*

Challenge 345 s Could one put a satellite into orbit using a cannon? Does the answer depend on the direction in which one shoots?

\* \*

Two computer users share experiences. ‘I threw my Pentium III and Pentium IV out of the window.’ ‘And?’ ‘The Pentium III was faster.’

\* \*

Challenge 346 s How often does the Earth rise and fall when seen from the Moon? Does the Earth show

phases?

\* \*

Challenge 347 ny What is the weight of the Moon? How does it compare with the weight of the Alps?

\* \*

Owing to the slightly flattened shape of the Earth, the source of the Mississippi is about 20 km nearer to the centre of the Earth than its mouth; the water effectively runs uphill.  
Challenge 348 s How can this be?

\* \*

Challenge 349 s If a star is made of high density material, the speed of a planet orbiting near to it could be greater than the speed of light. How does nature avoid this strange possibility?

\* \*

Ref. 153  
Page 324 What will happen to the solar system in the future? This question is surprisingly hard to answer. The main expert of this topic, French planetary scientist Jacques Laskar, simulated a few hundred million years of evolution using computer-aided calculus. He found that the planetary orbits are stable, but that there is clear evidence of chaos in the evolution of the solar system, at a small level. The various planets influence each other in subtle and still poorly understood ways. Effects in the past are also being studied, such as the energy change of Jupiter due to its ejection of smaller asteroids from the solar system, or energy gains of Neptune. There is still a lot of research to be done in this field.

\* \*

One of the open problems of the solar system is the description of planet distances discovered in 1766 by Johann Daniel Titius (1729–1796) and publicized by Johann Elert Bode (1747–1826). Titius discovered that planetary distances  $d$  from the Sun can be approximated by

$$d = a + 2^n b \quad \text{with} \quad a = 0.4 \text{ AU}, \quad b = 0.3 \text{ AU} \quad (57)$$

where distances are measured in astronomical units and  $n$  is the number of the planet. The resulting approximation is compared with observations in Table 26.

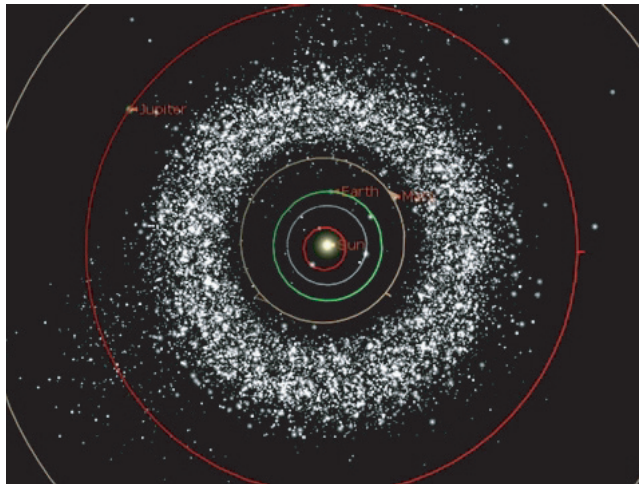
Interestingly, the last three planets, as well as the planetoids, were discovered *after* Bode's and Titius' deaths; the rule had successfully predicted Uranus' distance, as well as that of the planetoids. Despite these successes – and the failure for the last two planets – nobody has yet found a model for the formation of the planets that explains Titius' rule. The large satellites of Jupiter and of Uranus have regular spacing, but not according to the Titius–Bode rule.

Ref. 154  
Ref. 155 Explaining or disproving the rule is one of the challenges that remains in classical mechanics. Some researchers maintain that the rule is a consequence of scale invariance, others maintain that it is an accident or even a red herring. The last interpretation is also suggested by the non-Titius–Bode behaviour of practically all extrasolar planets. The issue is not closed.

\* \*

**TABLE 26** An unexplained property of nature: planet distances and the values resulting from the Titius–Bode rule.

PLANET	$n$	PREDICTED	MEASURED
DISTANCE IN AU			
Mercury	$-\infty$	0.4	0.4
Venus	0	0.7	0.7
Earth	1	1.0	1.0
Mars	2	1.6	1.5
Planetoids	3	2.8	2.2 to 3.2
Jupiter	4	5.2	5.2
Saturn	5	10.0	9.5
Uranus	6	19.6	19.2
Neptune	7	38.8	30.1
Pluto	8	77.2	39.5



**FIGURE 135** The motion of the planetoids compared to that of the planets (Shockwave animation © Hans-Christian Greier)

Around 3000 years ago, the Babylonians had measured the orbital times of the seven celestial bodies. Ordered from longest to shortest, they wrote them down in [Table 27](#).

The Babylonians also introduced the week and the division of the day into 24 hours. The Babylonians dedicated every one of the 168 hours of the week to a celestial body, following the order of [Table 27](#). They also dedicated the whole day to that celestial body that corresponds to the first hour of that day. The first day of the week was dedicated to Saturn; the present ordering of the other days of the week then follows from [Table 27](#). This story was told by Cassius Dio (c. 160 to c. 230). Towards the end of Antiquity, the ordering was taken up by the Roman empire. In Germanic languages, including English, the Latin names of the celestial bodies were replaced by the corresponding Germanic gods. The order Saturday, Sunday, Monday, Tuesday, Wednesday, Thursday and Friday is thus a

Challenge 350 e  
Ref. 156

TABLE 27 The orbital periods known to the Babylonians.

B O D Y	P E R I O D
Saturn	29 a
Jupiter	12 a
Mars	687 d
Sun	365 d
Venus	224 d
Mercury	88 d
Moon	29 d

consequence of both the astronomical measurements and the astrological superstitions of the ancients.

\* \*

In 1722, the great mathematician Leonhard Euler made a mistake in his calculation that led him to conclude that if a tunnel were built from one pole of the Earth to the other, a stone falling into it would arrive at the Earth's centre and then immediately turn and go back up. Voltaire made fun of this conclusion for many years. Can you correct Euler and show that the real motion is an oscillation from one pole to the other, and can you calculate the time a pole-to-pole fall would take (assuming homogeneous density)?

Challenge 351 s

What would be the oscillation time for an arbitrary straight surface-to-surface tunnel of length  $l$ , thus *not* going from pole to pole?

Challenge 352 s

\* \*

Figure 136 shows a photograph of a solar eclipse taken from the Russian space station *Mir* and a photograph taken at the centre of the shadow from the Earth. Indeed, a global view of a phenomenon can be quite different from a local one. What is the speed of the shadow?

Challenge 353 s

\* \*

In 2005, satellite measurements have shown that the water in the Amazon river presses down the land up to 75 mm more in the season when it is full of water than in the season when it is almost empty.

Ref. 157

\* \*

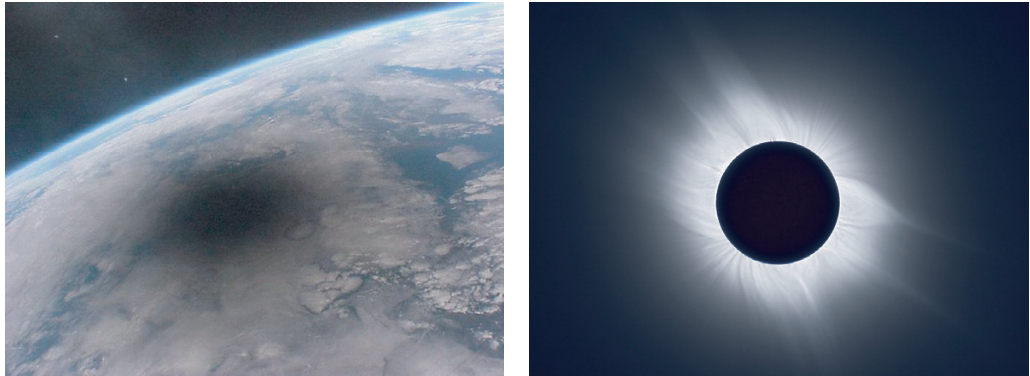
Assume that wires existed that do not break. How long would such a wire have to be so that, attached to the equator, it would stand upright in the air?

Challenge 354 s

\* \*

Everybody knows that there are roughly two tides per day. But there are places, such as on the coast of Vietnam, where there is only one tide per day. See [www.jason.oceanobs.com/html/applications/marees/marees\\_m2k1\\_fr.html](http://www.jason.oceanobs.com/html/applications/marees/marees_m2k1_fr.html). Why?

Challenge 355 ny



**FIGURE 136** The solar eclipse of 11 August 1999, photographed by Jean-Pierre Haigneré, member of the Mir 27 crew, and the (enhanced) solar eclipse of 29 March 2006 (© CNES and Laurent Laveder/PixHeaven.net).

\* \*

It is sufficient to use the concept of centrifugal force to show that the rings of Saturn cannot be made of massive material, but must be made of separate pieces. Can you find out how?

Challenge 356 s

\* \*

A painting is hanging on the wall of Dr. Dolittle's waiting room. He hung up the painting using two nails, and wound the picture wire around the nails in such a way that the painting would fall if either nail were pulled out. How did Dr. Dolittle do it?

Challenge 357 e

\* \*

Challenge 358 r Why did Mars lose its atmosphere? Nobody knows. It has recently been shown that the solar wind is too weak for this to happen. This is one of the many riddles of the solar system.

\* \*

Page 203 The observed motion due to gravity can be shown to be the simplest possible, in the following sense. If we measure change of a falling object with  $\int mv^2/2 - mghdt$ , then a constant acceleration due to gravity *minimizes* the change in every example of fall. Can you confirm this?

Challenge 359 ny

\* \*

Motion due to gravity is fun: think about roller coasters. If you want to know more at how they are built, visit [www.vekoma.com](http://www.vekoma.com).

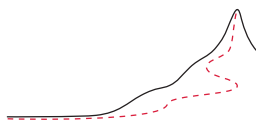
“The scientific theory I like best is that the rings of Saturn are made of lost airline luggage.”  
Mark Russel

**SUMMARY ON GRAVITATION**

Spherical bodies of mass  $m$  attract others at a distance  $r$  by inducing an acceleration towards them given by  $a = Gm/r^2$ . This expression, *universal gravity*, describes snowboarders, skiers, paragliders, athletes, couch potatoes, pendula, stones, canons, rockets, tides, eclipses, planets and much more. It is the first example of a unified description, in this case, of *everything falling*.







## CHAPTER 7

# CLASSICAL MECHANICS AND THE PREDICTABILITY OF MOTION

All those types of motion that can be described when the only permanent property of a body is mass, define the field of *mechanics*. The same name is also given to the experts studying the field. We can think of mechanics as the athletic part of physics;<sup>\*</sup> both in athletics and in mechanics only lengths, times and masses are measured.

More specifically, our topic of investigation so far is called *classical* mechanics, to distinguish it from *quantum* mechanics. The main difference is that in classical physics arbitrary small values are assumed to exist, whereas this is not the case in quantum physics. Classical mechanics is often also called *Galilean physics* or *Newtonian physics*.<sup>\*\*</sup>

Classical mechanics states that motion is *predictable*: it thus states that there are no surprises in motion. Is this correct in all cases? Let us start with the exploration of this issue.

We know that there is more to the world than gravity. A simple observation makes the point: *friction*. Friction cannot be due to gravity, because friction is not observed in the skies, where motion follows gravity rules only.<sup>\*\*\*</sup> Moreover, on Earth, friction is not related to gravity, as you might want to check. There must be another interaction responsible for friction. We shall study it shortly. But one issue merits a discussion right away.

Challenge 360 e

### SHOULD ONE USE FORCE? POWER?

“The direct use of force is such a poor solution to any problem, it is generally employed only by small children and large nations.”

David Friedman

Everybody has to take a stand on this question, even students of physics. Indeed, many types of forces are used and observed in daily life. One speaks of muscular, gravitational,

\* This is in contrast to the actual origin of the term ‘mechanics’, which means ‘machine science’. It derives from the Greek μηχανή, which means ‘machine’ and even lies at the origin of the English word ‘machine’ itself. Sometimes the term ‘mechanics’ is used for the study of motion of *solid* bodies only, excluding, e.g., hydrodynamics. This use fell out of favour in physics in the twentieth century.

\*\* The basis of classical mechanics, the description of motion using only space and time, is called *kinematics*. An example is the description of free fall by  $z(t) = z_0 + v_0(t - t_0) - \frac{1}{2}g(t - t_0)^2$ . The other, main part of classical mechanics is the description of motion as a consequence of interactions between bodies; it is called *dynamics*. An example of dynamics is the formula of universal gravity. The distinction between kinematics and dynamics can also be made in relativity, thermodynamics and electrodynamics.

\*\*\* This is not completely correct: in the 1980s, the first case of gravitational friction was discovered: the emission of gravity waves. We discuss it in detail in the chapter on general relativity.

TABLE 28 Some force values in nature.

OBSERVATION	FORCE
Value measured in a magnetic resonance force microscope	820 zN
Force needed to rip a DNA molecule apart by pulling at its two ends	600 pN
Maximum force exerted by human bite	2.1 kN
Typical peak force exerted by sledgehammer	2 kN
Force exerted by quadriceps	up to 3 kN
Force sustained by 1 cm <sup>2</sup> of a good adhesive	up to 10 kN
Force needed to tear a good rope used in rock climbing	30 kN
Maximum force measurable in nature	3.0 · 10 <sup>43</sup> N

psychic, sexual, satanic, supernatural, social, political, economic and many others. Physicists see things in a simpler way. They call the different types of forces observed between objects *interactions*. The study of the details of all these interactions will show that, in everyday life, they are of electrical origin.

For physicists, all change is due to motion. The term force then also takes on a more restrictive definition. (*Physical*) *force* is defined as the *change of momentum with time*, i.e., as

$$F = \frac{dp}{dt} . \tag{58}$$

Since momentum is conserved, we can say that force measures the *flow* of momentum. If a force acts on a body, momentum flows into it. Indeed, momentum can be imagined to be some invisible and intangible liquid. Force measures how much of this liquid flows from one body to another per unit time.

Using the Galilean definition of linear momentum  $p = mv$ , we can rewrite the definition of force (for constant mass) as

$$F = ma , \tag{59}$$

where  $F = F(t, \mathbf{x})$  is the force acting on an object of mass  $m$  and where  $\mathbf{a} = \mathbf{a}(t, \mathbf{x}) = d\mathbf{v}/dt = d^2\mathbf{x}/dt^2$  is the acceleration of the same object, that is to say its change of velocity.\* The expression states in precise terms that force is what changes the *velocity* of masses. The quantity is called ‘force’ because it corresponds in many, but *not* all aspects to muscular force. For example, the more force is used, the further a stone can be thrown.

However, whenever the concept of force is used, it should be remembered that *physical force is different from everyday force or everyday effort*. Effort is probably best approximated by the concept of (*physical*) *power*, usually abbreviated  $P$ , and defined (for

\* This equation was first written down by the Swiss mathematician and physicist Leonhard Euler (1707–1783) in 1747, 20 years after the death of Newton, to whom it is usually and falsely ascribed. It was Euler, one of the greatest mathematicians of all time, not Newton, who first understood that this definition of force is useful in *every* case of motion, whatever the appearance, be it for point particles or extended objects, and be it rigid, deformable or fluid bodies. Surprisingly and in contrast to frequently-made statements, equation (59) is even correct in relativity, as shown on page 74.

Ref. 26

constant force) as

$$P = \frac{dW}{dt} = \mathbf{F} \cdot \mathbf{v} \quad (60)$$

in which (*physical*) work  $W$  is defined as  $W = \mathbf{F} \cdot \mathbf{s}$ . Physical work is a form of energy, as you might want to check. Work, as a form of energy, has to be taken into account when the conservation of energy is checked. Note that a man who walks carrying a heavy rucksack is hardly doing any work; why then does he get tired?

Challenge 361 s

Challenge 362 s

Challenge 363 d

With the definition of work just given you can solve the following puzzles. What happens to the electricity consumption of an escalator if you walk on it instead of standing still? What is the effect of the definition of power for the salary of scientists?

Ref. 158

When students in exams say that the force acting on a thrown stone is least at the highest point of the trajectory, it is customary to say that they are using an incorrect view, namely the so-called *Aristotelian view*, in which force is proportional to velocity. Sometimes it is even said that they are using a different concept of *state* of motion. Critics then add, with a tone of superiority, how wrong all this is. This is an example of intellectual disinformation. Every student knows from riding a bicycle, from throwing a stone or from pulling an object that increased effort results in increased speed. The student is right; those theoreticians who deduce that the student has a mistaken concept of *force* are wrong. In fact, instead of the *physical* concept of force, the student is just using the *everyday* version, namely effort. Indeed, the effort exerted by gravity on a flying stone is least at the highest point of the trajectory. Understanding the difference between physical force and everyday effort is the main hurdle in learning mechanics.\*

Often the flow of momentum, equation (58), is not recognized as the definition of force. This is mainly due to an everyday observation: there seem to be forces without any associated acceleration or change in momentum, such as in a string under tension or in water at high pressure. When one pushes against a tree, there is no motion, yet a force is applied. If force is momentum flow, where does the momentum go? It flows into the slight deformations of the arms and the tree. In fact, when one starts pushing and thus deforming, the associated momentum change of the molecules, the atoms, or the electrons of the two bodies can be observed. After the deformation is established, and looking at even higher magnification, one can indeed find that a continuous and equal flow of momentum is going on in both directions. The nature of this flow will be clarified in our exploration of quantum theory.

As force is net momentum flow, it is only needed as a separate concept in everyday life, where it is useful in situations where net momentum flows are less than the total flows. At the microscopic level, momentum alone suffices for the description of motion. For example, the concept of *weight* describes the flow of momentum due to gravity. Thus we will hardly ever use the term 'weight' in the microscopic part of our adventure.

Before we can answer the question in the title, on the usefulness of force and power, we need more arguments. Through its definition, the concept of force is distinguished clearly from 'mass', 'momentum', 'energy' and 'power'. But where do forces originate? In

\* This stepping stone is so high that many professional physicists do not really take it themselves; this is confirmed by the innumerable comments in papers that state that physical force is defined using mass, and, at the same time, that mass is defined using force (the latter part of the sentence being a fundamental mistake).

other words, which effects in nature have the capacity to accelerate bodies by pumping momentum into objects? Table 29 gives an overview.

**FORCES, SURFACES AND CONSERVATION**

We saw that force is the change of momentum. We also saw that momentum is conserved. How do these statements come together? The answer is the same for all conserved quantities. We imagine a closed surface that is the boundary of a volume in space. Conservation implies that the conserved quantity enclosed *inside* the surface can only change by flowing *through* that surface.\*

All conserved quantities in nature – such as energy, linear momentum, electric charge, angular momentum – can only change by flowing through surfaces. In particular, when the momentum of a body changes, this happens through a surface. Momentum change is due to momentum flow. In other words, the concept of force always assumes a surface through which momentum flows.

▷ Force is the flow of momentum through a surface.

Ref. 250 This point is essential in understanding physical force! Every force requires a surface for its definition.

Challenge 364 e To refine your own concept of force, you can search for the relevant surface when a rope pulls a chariot, or when an arm pushes a tree, or when a car accelerates. It is also helpful to compare the definition of force with the definition of power: both are flows through surfaces.

**FRICTION AND MOTION**

Every example of motion, from the one that lets us choose the direction of our gaze to the one that carries a butterfly through the landscape, can be put into one of the two leftmost columns of Table 29. Physically, the two columns are separated by the following criterion: in the first class, the acceleration of a body can be in a different direction from its velocity. The second class of examples produces only accelerations that are exactly *opposed* to the velocity of the moving body, as seen from the frame of reference of the braking medium. Such a resisting force is called *friction*, *drag* or a *damping*. All examples in the second class are types of friction. Just check.

Challenge 365 e

Challenge 366 s

A puzzle on cycling: does side wind brake – and why?

\* Mathematically, the conservation of a quantity  $q$  is expressed with the help of the volume density  $\rho = q/V$ , the current  $I = q/t$ , and the flow or flux  $j = \rho v$ , so that  $j = q/At$ . Conservation then implies

$$\frac{dq}{dt} = \int_V \frac{\partial \rho}{\partial t} dV = - \int_{A=\partial V} j dA = -I \tag{61}$$

or, equivalently,

$$\frac{\partial \rho}{\partial t} + \nabla j = 0 . \tag{62}$$

This is the *continuity equation* for the quantity  $q$ . All this only states that a conserved quantity in a closed volume  $V$  can only change by flowing through the surface  $A$ . This is a typical example of how complex mathematical expressions can obfuscate the simple physical content.

TABLE 29 Selected processes and devices changing the motion of bodies.

SITUATIONS THAT CAN LEAD TO ACCELERATION	SITUATIONS THAT ONLY LEAD TO DECELERATION	MOTORS AND ACTUATORS
<i>piezoelectricity</i>		
quartz under applied voltage	thermoluminescence	walking piezo tripod
<i>collisions</i>		
satellite in planet encounter	car crash	rocket motor
growth of mountains	meteorite crash	swimming of larvae
<i>magnetic effects</i>		
compass needle near magnet	electromagnetic braking	electromagnetic gun
magnetostriction	transformer losses	linear motor
current in wire near magnet	electric heating	galvanometer
<i>electric effects</i>		
rubbed comb near hair	friction between solids	electrostatic motor
bombs	fire	muscles, sperm flagella
television tube	electron microscope	Brownian motor
<i>light</i>		
levitating objects by light	light bath stopping atoms	(true) light mill
solar sail for satellites	light pressure inside stars	solar cell
<i>elasticity</i>		
bow and arrow	trouser suspenders	ultrasound motor
bent trees standing up again	pillow, air bag	bimorphs
<i>osmosis</i>		
water rising in trees	salt conservation of food	osmotic pendulum
electro-osmosis		tunable X-ray screening
<i>heat &amp; pressure</i>		
freezing champagne bottle	surfboard water resistance	hydraulic engines
tea kettle	quicksand	steam engine
barometer	parachute	air gun, sail
earthquakes	sliding resistance	seismometer
attraction of passing trains	shock absorbers	water turbine
<i>nuclei</i>		
radioactivity	plunging into the Sun	supernova explosion
<i>biology</i>		
bamboo growth	decreasing blood vessel diameter	molecular motors
<i>gravitation</i>		
falling	emission of gravity waves	pulley

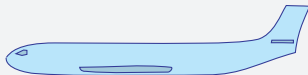
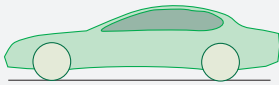


	typical passenger aeroplane	$c_W = 0.03$
	typical sports car or van	$c_W = 0.44$
	modern sedan	$c_W = 0.28$
	dolphin and penguin	$c_W = 0.035$
	soccer ball	
	turbulent (above c. 10 m/s)	$c_W = 0.2$
	laminar (below c. 10 m/s)	$c_W = 0.45$

FIGURE 137 Shapes and air/water resistance.

Friction can be so strong that all motion of a body against its environment is made impossible. This type of friction, called *static friction* or *sticking friction*, is common and important: without it, turning the wheels of bicycles, trains or cars would have no effect. Without static friction, wheels driven by a motor would have no grip. Similarly, not a single screw would stay tightened and no hair clip would work. We could neither run nor walk in a forest, as the soil would be more slippery than polished ice. In fact not only our own motion, but all *voluntary motion* of living beings is *based* on friction. The same is the case for self-moving machines. Without static friction, the propellers in ships, aeroplanes and helicopters would not have any effect and the wings of aeroplanes would produce no lift to keep them in the air. (Why?) In short, static friction is required whenever we or an engine want to move relative to our environment.

Challenge 367 s

### FRICITION, SPORT, MACHINES AND PREDICTABILITY

Once an object moves through its environment, it is hindered by another type of friction; it is called *dynamic friction* and acts between bodies in relative motion. Without it, falling bodies would always rebound to the same height, without ever coming to a stop; neither parachutes nor brakes would work; worse, we would have no memory, as we will see later.\*

Ref. 159

All motion examples in the second column of Table 29 include friction. In these examples, macroscopic energy is not conserved: the systems are *dissipative*. In the first column, macroscopic energy is constant: the systems are *conservative*.

The first two columns can also be distinguished using a more abstract, mathematical criterion: on the left are accelerations that can be derived from a potential, on the right, decelerations that can not. As in the case of gravitation, the description of any kind of

\* Recent research suggest that maybe in certain crystalline systems, such as tungsten bodies on silicon, under ideal conditions gliding friction can be extremely small and possibly even vanish in certain directions of motion. This so-called *superlubrication* is presently a topic of research.

Ref. 160

motion is much simplified by the use of a potential: at every position in space, one needs only the single value of the potential to calculate the trajectory of an object, instead of the three values of the acceleration or the force. Moreover, the magnitude of the velocity of an object at any point can be calculated directly from energy conservation.

The processes from the second column *cannot* be described by a potential. These are the cases where we necessarily have to use force if we want to describe the motion of the system. For example, the *friction* or *drag* force  $F$  due to wind resistance of a body is *roughly* given by

$$F = \frac{1}{2} c_w \rho A v^2 \quad (63)$$

where  $A$  is the area of its cross-section and  $v$  its velocity relative to the air,  $\rho$  is the density of air; the *drag coefficient*  $c_w$  is a pure number that depends on the shape of the moving object. (A few examples are given in [Figure 137](#). The formula is valid for all fluids, not only for air, below the speed of sound, as long as the drag is due to turbulence. This is usually the case in air and in water. At low velocities, when the fluid motion is not turbulent but laminar, drag is called *viscous* and follows an (almost) linear relation with speed.) You may check that aerodynamic resistance cannot be derived from a potential.\*

Challenge 368 ny

The drag coefficient  $c_w$  is a measured quantity.\*\* An aerodynamic car has a value between 0.25 and 0.3; many sports cars share with vans values of 0.44 and higher, and racing car values can be as high as 1, depending on the amount of the force that is used to keep the car fastened to the ground. The lowest known values are for dolphins and penguins.

Ref. 162

Wind resistance is also of importance to humans, in particular in athletics. It is estimated that 100 m sprinters spend between 3 % and 6 % of their power overcoming drag. This leads to varying sprint times  $t_w$  when wind of speed  $w$  is involved, related by the expression

$$\frac{t_0}{t_w} = 1.03 - 0.03 \left( 1 - \frac{wt_w}{100 \text{ m}} \right)^2, \quad (64)$$

where the more conservative estimate of 3 % is used. An opposing wind speed of  $-2$  m/s gives an increase in time of 0.13 s, enough to change a potential world record into an 'only' excellent result. (Are you able to deduce the  $c_w$  value for running humans from the formula?)

Challenge 370 ny

Challenge 371 s

Likewise, parachuting exists due to wind resistance. Can you determine how the speed of a falling body changes with time, assuming *constant* shape and drag coefficient?

Challenge 369 s

\* Such a statement about friction is correct only in three dimensions, as is the case in nature; in the case of a single dimension, a potential can *always* be found.

\*\* Calculating drag coefficients in computers, given the shape of the body and the properties of the fluid, is one of the most difficult tasks of science; the problem is still not solved.

The topic of aerodynamic shapes is even more interesting for fluid bodies. They are kept together by *surface tension*. For example, surface tension keeps the hairs of a wet brush together. Surface tension also determines the shape of rain drops. Experiments show that it is spherical for drops smaller than 2 mm diameter, and that larger rain drops are *lens* shaped, with the flat part towards the bottom. The usual tear shape is *not* encountered in nature; something vaguely similar to it appears during drop detachment, but *never* during drop fall.

Vol. V, page 229

Ref. 161



Ref. 163 In contrast, static friction has different properties. It is proportional to the force pressing the two bodies together. Why? Studying the situation in more detail, sticking friction is found to be proportional to the actual contact area. It turns out that putting two solids into contact is rather like turning Switzerland upside down and putting it onto Austria; the area of contact is much smaller than that estimated macroscopically. The important point is that the area of actual contact is proportional to the *normal* force. The study of what happens in that contact area is still a topic of research; researchers are investigating the issues using instruments such as atomic force microscopes, lateral force microscopes and triboscopes. These efforts resulted in computer hard discs which last longer, as the friction between disc and the reading head is a central quantity in determining the lifetime.

All forms of friction are accompanied by an increase in the temperature of the moving body. The reason became clear after the discovery of atoms. Friction is not observed in few – e.g. 2, 3, or 4 – particle systems. Friction only appears in systems with many particles, usually millions or more. Such systems are called *dissipative*. Both the temperature changes and friction itself are due to the motion of large numbers of microscopic particles against each other. This motion is not included in the Galilean description. When it is included, friction and energy loss disappear, and potentials can then be used throughout. Positive accelerations – of microscopic magnitude – then also appear, and motion is found to be conserved. As a result, all motion is conservative on a microscopic scale. Therefore, on a microscopic scale it is possible to describe *all* motion without the concept of force.\*

The moral of the story is twofold: First, one should use force and power only in one situation: in the case of friction, and only when one does not want to go into the microscopic details.\*\* Secondly, friction is not an obstacle to predictability.

“ Et qu'avons-nous besoin de ce moteur, quand l'étude réfléchie de la nature nous prouve que le mouvement perpétuel est la première de ses lois ?\*\*\* ”  
Donatien de Sade *Justine, ou les malheurs de la vertu.*

\* The first scientist who eliminated force from the description of nature was Heinrich Rudolf Hertz (b. 1857 Hamburg, d. 1894 Bonn), the famous discoverer of electromagnetic waves, in his textbook on mechanics, *Die Prinzipien der Mechanik*, Barth, 1894, republished by Wissenschaftliche Buchgesellschaft, Darmstadt, 1963. His idea was strongly criticized at that time; only a generation later, when quantum mechanics quietly got rid of the concept for good, did the idea become commonly accepted. (Many have speculated about the role Hertz would have played in the development of quantum mechanics and general relativity, had he not died so young.) In his book, Hertz also formulated the principle of the straightest path: particles follow geodesics. This same description is one of the pillars of general relativity, as we will see later on.

Ref. 164 \*\* In the case of human relations the evaluation should be somewhat more discerning, as the research by James Gilligan shows.

\*\*\* 'And what for do we need this motor, when the reasoned study of nature proves to us that perpetual motion is the first of its laws?'

## COMPLETE STATES – INITIAL CONDITIONS

“Quid sit futurum cras, fuge quaerere ...”  
Horace, *Odi*, lib. I, ode 9, v. 13.

Let us continue our exploration of the predictability of motion. We often describe the motion of a body by specifying the time dependence of its position, for example as

$$\mathbf{x}(t) = \mathbf{x}_0 + \mathbf{v}_0(t - t_0) + \frac{1}{2}\mathbf{a}_0(t - t_0)^2 + \frac{1}{6}\mathbf{j}_0(t - t_0)^3 + \dots \quad (65)$$

The quantities with an index 0, such as the starting position  $\mathbf{x}_0$ , the starting velocity  $\mathbf{v}_0$ , etc., are called *initial conditions*. Initial conditions are necessary for any description of motion. Different physical systems have different initial conditions. Initial conditions thus specify the *individuality* of a given system. Initial conditions also allow us to distinguish the present situation of a system from that at any previous time: initial conditions specify the *changing aspects* of a system. In other words, they summarize the past of a system.

Page 25 Initial conditions are thus precisely the properties we have been seeking for a description of the *state* of a system. To find a complete description of states we thus need only a complete description of initial conditions, which we can thus rightly call also *initial states*. It turns out that for gravitation, as for all other microscopic interactions, there is *no* need for initial acceleration  $\mathbf{a}_0$ , initial jerk  $\mathbf{j}_0$ , or higher-order initial quantities. In nature, acceleration and jerk depend only on the properties of objects and their environment; they do not depend on the past. For example, the expression  $a = GM/r^2$  of universal gravity, giving the acceleration of a small body near a large one, does not depend on the past, but only on the environment. The same happens for the other fundamental interactions, as we will find out shortly.

Page 79 The *complete state* of a moving mass point is thus described by specifying its position and its momentum at all instants of time. Thus we have now achieved a complete description of the *intrinsic properties* of point objects, namely by their mass, and of their *states of motion*, namely by their momentum, energy, position and time. For *extended rigid* objects we also need orientation, angular velocity and angular momentum. Can you specify the necessary quantities in the cases of extended elastic bodies and of fluids?

Challenge 372 s The set of all possible states of a system is given a special name: it is called the *phase space*. We will use the concept repeatedly. Like any space, it has a number of dimensions.

Challenge 373 s Can you specify it for a system consisting of  $N$  point particles?

Challenge 374 s Given that we have a description of both properties and states of point objects, extended rigid objects and deformable bodies, can we predict all motion? Not yet. There are situations in nature where the motion of an object depends on characteristics other than its mass; motion can depend on its colour (can you find an example?), on its temperature, and on a few other properties that we will soon discover. Can you give an example of an intrinsic property that we have so far missed? And for each intrinsic property there are state variables to discover. These new properties are the basis of the field of physical

Challenge 375 s

Ref. 76 \* ‘What future will be tomorrow, never ask ...’ Horace is Quintus Horatius Flaccus (65–8 BCE), the great Roman poet.

enquiry beyond mechanics. We must therefore conclude that as yet we do not have a complete description of motion.

Challenge 376 s

It is interesting to recall an older challenge and ask again: does the universe have initial conditions? Does it have a phase space? As a hint, recall that when a stone is thrown, the initial conditions summarize the effects of the thrower, his history, the way he got there etc.; in other words, initial conditions summarize the effects that the environment had during the history of a system.

“An optimist is somebody who thinks that the future is uncertain.”  
Anonymous

DO SURPRISES EXIST? IS THE FUTURE DETERMINED?

“Die Ereignisse der Zukunft können wir nicht aus den gegenwärtigen erschließen. Der Glaube an den Kausalnexus ist ein Aberglaube.\*  
Ludwig Wittgenstein, *Tractatus*, 5.1361

“Freedom is the recognition of necessity.”  
Friedrich Engels (1820–1895)

Challenge 377 e

If, after climbing a tree, we jump down, we cannot halt the jump in the middle of the trajectory; once the jump has begun, it is unavoidable and determined, like all passive motion. However, when we begin to move an arm, we can stop or change its motion from a hit to a caress. Voluntary motion does not seem unavoidable or predetermined. Which of these two cases is the general one?

Let us start with the example that we can describe most precisely so far: the fall of a body. Once the potential  $\varphi$  acting on a particle is given and taken into account, using

$$\mathbf{a}(x) = -\nabla\varphi = -GM\mathbf{r}/r^3, \tag{66}$$

and once the state at a given time is given by initial conditions such as

$$\mathbf{x}(t_0) \text{ and } \mathbf{v}(t_0), \tag{67}$$

we then can determine the motion of the particle in advance. The complete trajectory  $\mathbf{x}(t)$  can be calculated with these two pieces of information.

An equation that has the potential to predict the course of events is called an *evolution equation*. Equation (66), for example, is an evolution equation for the motion of the object. (Note that the term ‘evolution’ has different meanings in physics and in biology.) An evolution equation embraces the observation that not all types of change are observed in nature, but only certain specific cases. Not all imaginable sequences of events are observed, but only a limited number of them. In particular, equation (66) embraces the idea that from one instant to the next, objects change their motion based on the poten-

\* ‘We cannot infer the events of the future from those of the present. Belief in the causal nexus is superstition.’

tial acting on them. Given an evolution equation and initial state, the whole motion of a system is *uniquely fixed*, a property of motion often called *determinism*.

Let us carefully distinguish determinism from several similar concepts, to avoid misunderstandings. Motion can be deterministic and at the same time be *unpredictable in practice*. The unpredictability of motion can have four origins:

1. an impracticably large number of particles involved,
2. the mathematical complexity of the evolution equations,
3. insufficient information about initial conditions, and
4. strange shapes of space-time.

For example, in case of the weather the first three conditions are fulfilled at the same time. Nevertheless, weather change is still deterministic. As another example, near black holes all four origins apply together. We will discuss black holes in the section on general relativity. Despite being unpredictable, motion is deterministic near black holes.

Motion can be both deterministic and time *random*, i.e., with different outcomes in similar experiments. A roulette ball's motion is deterministic, but it is also random.\* As we will see later, quantum-mechanical situations fall into this category, as do all examples of irreversible motion, such as a drop of ink spreading out in clear water. In all such cases the randomness and the irreproducibility are only apparent; they disappear when the description of states and initial conditions in the microscopic domain are included. In short, determinism does not contradict (*macroscopic*) *irreversibility*. However, on the microscopic scale, deterministic motion is always reversible.

A final concept to be distinguished from determinism is *acausality*. Causality is the requirement that a cause must precede the effect. This is trivial in Galilean physics, but becomes of importance in special relativity, where causality implies that the speed of light is a limit for the spreading of effects. Indeed, it seems impossible to have deterministic motion (of matter and energy) which is *acausal*, in other words, faster than light. Can you confirm this? This topic will be looked at more deeply in the section on special relativity.

Challenge 378 s

Saying that motion is 'deterministic' means that it is fixed in the future *and also in the past*. It is sometimes stated that predictions of *future* observations are the crucial test for a successful description of nature. Owing to our often impressive ability to influence the future, this is not necessarily a good test. Any theory must, first of all, describe *past* observations correctly. It is our lack of freedom to change the past that results in our lack of choice in the description of nature that is so central to physics. In this sense, the term 'initial condition' is an unfortunate choice, because it automatically leads us to search for the initial condition of the universe and to look there for answers to questions that can be answered without that knowledge. The central ingredient of a deterministic description is that all motion can be reduced to an evolution equation plus one specific state. This state can be either initial, intermediate, or final. Deterministic motion is uniquely specified into the past and into the future.

To get a clear concept of determinism, it is useful to remind ourselves why the concept of 'time' is introduced in our description of the world. We introduce time because

\* Mathematicians have developed a large number of tests to determine whether a collection of numbers may be called *random*; roulette results pass all these tests – in honest casinos only, however. Such tests typically check the equal distribution of numbers, of pairs of numbers, of triples of numbers, etc. Other tests are the  $\chi^2$  test, the Monte Carlo test(s), and the gorilla test.

Ref. 165

Challenge 379 s

we observe first that we are able to define sequences in observations, and second, that unrestricted change is impossible. This is in contrast to films, where one person can walk through a door and exit into another continent or another century. In nature we do not observe metamorphoses, such as people changing into toasters or dogs into toothbrushes. We are able to introduce 'time' only because the sequential changes we observe are extremely restricted. If nature were not reproducible, time could not be used. In short, determinism expresses the observation that *sequential changes are restricted to a single possibility*.

Since determinism is connected to the use of the concept of time, new questions arise whenever the concept of time changes, as happens in special relativity, in general relativity and in theoretical high energy physics. There is a lot of fun ahead.

Vol. V, page 35

In summary, every description of nature that uses the concept of time, such as that of everyday life, that of classical physics and that of quantum mechanics, is intrinsically and inescapably deterministic, since it connects observations of the past and the future, *eliminating* alternatives. In short, *the use of time implies determinism, and vice versa*. When drawing metaphysical conclusions, as is so popular nowadays when discussing quantum theory, one should never forget this connection. Whoever uses clocks but denies determinism is nurturing a split personality!\*

### FREE WILL

“ You do have the ability to surprise yourself. ”  
Richard Bandler and John Grinder

The idea that motion is determined often produces fear, because we are taught to associate determinism with lack of freedom. On the other hand, we do experience freedom in our actions and call it *free will*. We know that it is necessary for our creativity and for our happiness. Therefore it seems that determinism is opposed to happiness.

But what precisely is free will? Much ink has been consumed trying to find a precise definition. One can try to define free will as the arbitrariness of the choice of initial conditions. However, initial conditions must themselves result from the evolution equations, so that there is in fact no freedom in their choice. One can try to define free will from the idea of unpredictability, or from similar properties, such as uncomputability. But these definitions face the same simple problem: whatever the definition, there is *no way* to prove experimentally that an action was performed freely. The possible definitions are useless. In short, free will *cannot* be observed. (Psychologists also have a lot of their own data to support this, but that is another topic.)

No process that is *gradual* – in contrast to *sudden* – can be due to free will; gradual processes are described by time and are deterministic. In this sense, the question about free will becomes one about the existence of sudden changes in nature. This will be a recurring topic in the rest of this walk. Can nature surprise us? In everyday life, nature does not. Sudden changes are not observed. Of course, we still have to investigate this question in other domains, in the very small and in the very large. Indeed, we will change our opinion several times. The lack of surprises in everyday life is built deep into our

---

\* That can be a lot of fun though.

body: the concept of curiosity is based on the idea that everything discovered is useful afterwards. If nature continually surprised us, curiosity would make no sense.

Many observations contradict the existence of surprises: in the beginning of our walk we defined time using the continuity of motion; later on we expressed this by saying that time is a consequence of the conservation of energy. Conservation is the opposite of surprise. By the way, a challenge remains: can you show that time would not be definable even if surprises existed only *rarely*?

Challenge 380 s

In summary, so far we have no evidence that surprises exist in nature. Time exists because nature is deterministic. Free will cannot be defined with the precision required by physics. Given that there are no sudden changes, there is only one consistent definition of free will: it is a *feeling*, in particular of independence of others, of independence from fear and of accepting the consequences of one's actions. Free will is a feeling of satisfaction. This solves the apparent paradox; free will, being a feeling, exists as a human experience, even though all objects move without any possibility of choice. There is no contradiction.\*

Ref. 166

Ref. 167

Challenge 382 e

Even if human action is determined, it is still authentic. So why is determinism so frightening? That is a question everybody has to ask themselves. What difference does determinism imply for your life, for the actions, the choices, the responsibilities and the pleasures you encounter?\*\*\* If you conclude that being determined is different from being free, you should change your life! Fear of determinism usually stems from refusal to take the world the way it is. Paradoxically, it is precisely he who insists on the existence of free will who is running away from responsibility.

### SUMMARY ON PREDICTABILITY

Despite difficulties to predict specific cases, all motion we encountered so far is deterministic and predictable. In fact, this is the case for all motion in nature, even in the domain of quantum theory. If motion were not predictable, we could not have introduced the concept of 'motion' in the first place.

### GLOBAL DESCRIPTIONS OF MOTION

« Πλεῖν ἀνάγκη, ζῆν οὐκ ἀνάγκη.\*\*\* »  
Pompeius

\* That free will is a feeling can also be confirmed by careful introspection. The idea of free will always appears *after* an action has been started. It is a beautiful experiment to sit down in a quiet environment, with the intention to make, within an unspecified number of minutes, a small gesture, such as closing a hand. If you carefully observe, in all detail, what happens inside yourself around the very moment of decision, you find either a mechanism that led to the decision, or a diffuse, unclear mist. You never find free will. Such an experiment is a beautiful way to experience deeply the wonders of the self. Experiences of this kind might also be one of the origins of human spirituality, as they show the connection everybody has with the rest of nature.

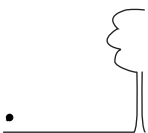
Challenge 381 e

Challenge 383 s

\*\* If nature's 'laws' are deterministic, are they in contrast with moral or ethical 'laws'? Can people still be held responsible for their actions?

Ref. 168

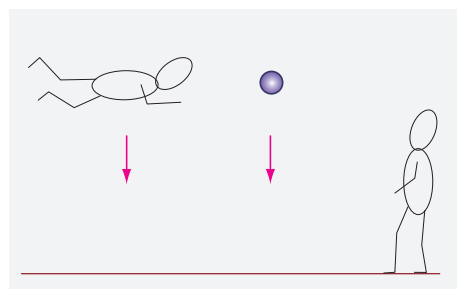
\*\*\* Navigare necesse, vivere non necesse. 'To navigate is necessary, to live is not.' Gnaeus Pompeius Magnus (106–48 BCE) is cited in this way by Plutarchus (c. 45 to c. 125).







**FIGURE 138** What shape of rail allows the black stone to glide most rapidly from point A to the lower point B?



**FIGURE 139** Can motion be described in a manner common to all observers?

All over the Earth – even in Australia – people observe that stones fall ‘down’. This ancient observation led to the discovery of the universal ‘law’ of gravity. To find it, all that was necessary was to look for a description of gravity that was valid globally. The only additional observation that needs to be recognized in order to deduce the result  $a = GM/r^2$  is the variation of gravity with height.

In short, thinking *globally* helps us to make our description of motion more precise and our predictions more useful. How can we describe motion as globally as possible? It turns out that there are six approaches to this question, each of which will be helpful on our way to the top of Motion Mountain. We first give an overview, and then explore the details of each approach.

1. *Variational principles*, the first global approach to motion, arises when we overcome a limitation of what we have learned so far. When we predict the motion of a particle from its current acceleration with an evolution equation, we are using the most *local* description of motion possible. We use the acceleration of a particle at a certain place and time to determine its position and motion *just after* that moment and *in the immediate neighbourhood* of that place. Evolution equations thus have a mental ‘horizon’ of radius zero.

The contrast to evolution equations are variational principles. A famous example is illustrated in **Figure 138**. The challenge is to find the path that allows the fastest possible gliding motion from a high point to a distant low point. The sought path is the *brachistochrone*, from ancient Greek for ‘shortest time’. This puzzle asks about a property of motion as a whole, for all times and positions. The global approach required by questions such as this one will lead us to a description of motion which is simple, precise and fascinating: the so-called principle of cosmic laziness, also known as the principle of least action.

2. *Relativity*, the second global approach to motion, emerges when we compare the various descriptions of the same system produced by different observers. For example, the observations by somebody falling from a cliff, a passenger in a roller coaster, and an observer on the ground will usually differ. The relationships between these observations lead us to a global description, valid for everybody. Later, this approach will lead us to Einstein’s special theory of relativity.
3. *Mechanics of extended and rigid bodies*, rather than mass points, is required to under-

Page 191

Challenge 384 d





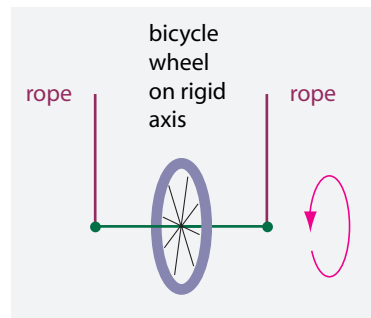


FIGURE 140 What happens when one rope is cut?

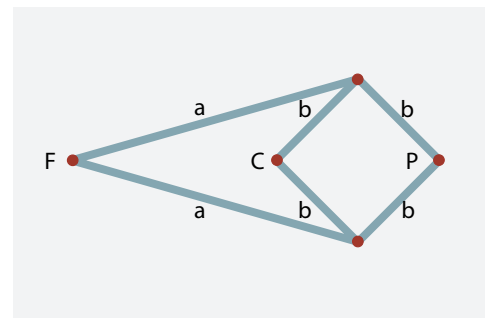


FIGURE 141 A famous mechanism, the Peaucellier-Lipkin linkage, that allows drawing a straight line with a compass: fix point F, put a pencil into joint P and move C with a compass along a circle.

stand many objects, plants and animals. As an example, the counter-intuitive result of the experiment in Figure 140 shows why this topic is worthwhile.

In order to design machines, it is essential to understand how a group of rigid bodies interact with one another. For example, take the Peaucellier-Lipkin linkage shown in Figure 141. A joint F is fixed on a wall. Two movable rods lead to two opposite corners of a movable rhombus, whose rods connect to the other two corners C and P. This mechanism has several astonishing properties. First of all, it implicitly defines a circle of radius  $R$  so that one always has the relation  $r_C = R^2/r_P$  between the distances of joints C and P from the centre of this circle. Can you find this special circle? Secondly, if you put a pencil in joint P, and let joint C follow a certain circle, the pencil P draws a straight line. Can you find that circle? The mechanism thus allows to draw a straight line with a compass.

Another famous machine challenge is to devise a wooden carriage, with gear-wheels that connect the wheels to an arrow, with the property that, whatever path the carriage takes, the arrow always points south (see Figure 142). The solution to this puzzle will even be useful in helping us to understand general relativity, as we will see. Such a wagon allows measuring the curvature of a surface and of space.

Another interesting example of rigid motion is the way that human movements, such as the general motions of an arm, are composed from a small number of basic motions. All these examples are from the fascinating field of engineering; unfortunately, we will have little time to explore this topic in our hike.

4. The next global approach to motion is the description of *non-rigid extended bodies*. For example, *fluid mechanics* studies the flow of fluids (like honey, water or air) around solid bodies (like spoons, ships, sails or wings). Fluid mechanics thus describes how insects, birds and aeroplanes fly,\* why sailing-boats can sail against the

\* The mechanisms of insect flight are still a subject of active research. Traditionally, fluid dynamics has concentrated on large systems, like boats, ships and aeroplanes. Indeed, the smallest human-made object that can fly in a controlled way – say, a radio-controlled plane or helicopter – is much larger and heavier than many flying objects that evolution has engineered. It turns out that controlling the flight of small things requires more knowledge and more tricks than controlling the flight of large things. There is more about

Ref. 169

Challenge 385 ny

Challenge 386 ny

Ref. 170

Challenge 387 d

Vol. II, page 188

Ref. 171



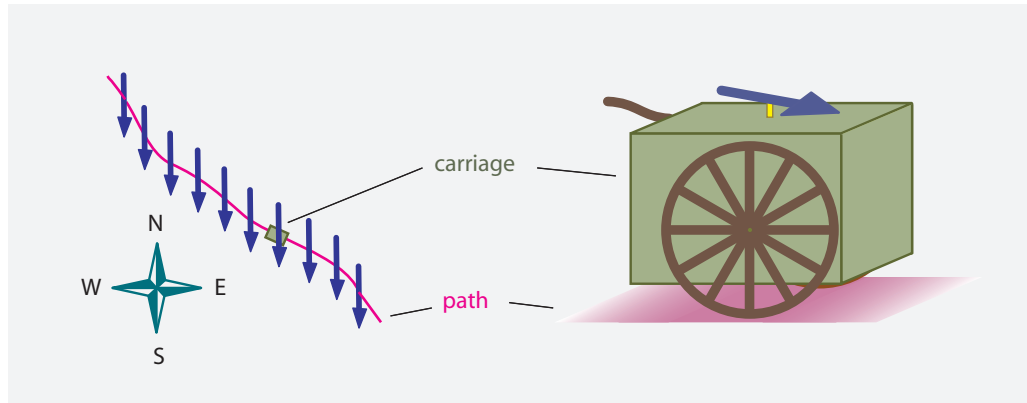


FIGURE 142 A south-pointing carriage: whatever the path it follows, the arrow on it always points south.

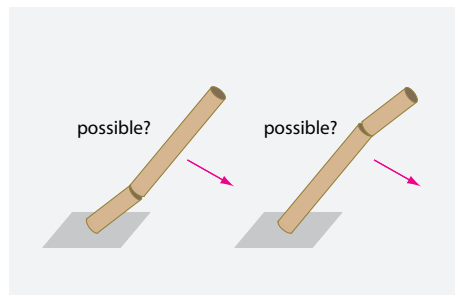


FIGURE 143 How and where does a falling brick chimney break?

Challenge 389 ny

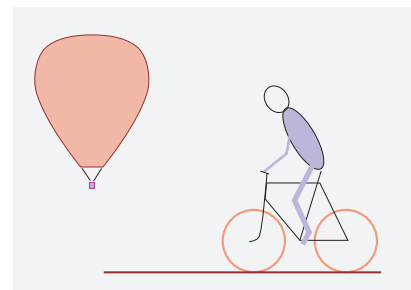


FIGURE 144 Why do hot-air balloons stay inflated? How can you measure the weight of a bicycle rider using only a ruler?

Ref. 172  
Challenge 388 s

Challenge 390 s

wind, what happens when a hard-boiled egg is made to spin on a thin layer of water, or how a bottle full of wine can be emptied in the fastest way possible.

As well as fluids, we can study the behaviour of deformable *solids*. This area of research is called *continuum mechanics*. It deals with deformations and oscillations of extended structures. It seeks to explain, for example, why bells are made in particular shapes; how large bodies – such as falling chimneys – or small bodies – such as diamonds – break when under stress; and how cats can turn themselves the right way up as they fall. During the course of our journey we will repeatedly encounter issues from this field, which impinges even upon general relativity and the world of elementary particles.

5. *Statistical mechanics* is the study of the motion of huge numbers of particles. Statistical mechanics is yet another global approach to the study of motion. The concepts needed to describe gases, such as temperature, entropy and pressure (see Figure 144), are essential tools of this discipline. These concepts will also help us take our first steps towards the understanding of black holes.

this topic on [page 203](#).



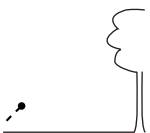


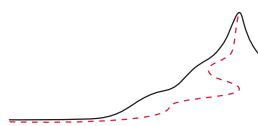
**FIGURE 145** Why do marguerites – or ox-eye daisies, *Leucanthemum vulgare* – usually have around 21 (left and centre) or around 34 (right) petals? (© Anonymous, Giorgio Di Iorio and Thomas Lüthi).

6. The last global approach to motion, *self-organization*, involves all of the above-mentioned viewpoints *at the same time*. Such an approach is needed to understand everyday experience, and *life* itself. Why does a flower form a specific number of petals? How does an embryo differentiate in the womb? What makes our hearts beat? How do mountains ridges and cloud patterns emerge? How do stars and galaxies evolve? How are sea waves formed by the wind?

All these are examples of *self-organization* processes; life scientists simply speak of *growth* processes. Whatever we call them, all these processes are characterized by the spontaneous appearance of patterns, shapes and cycles. Such processes are a common research theme across many disciplines, including biology, chemistry, medicine, geology and engineering.

We will now explore to these six global approaches to motion. We will begin with the first approach, namely, the global description of motion using a variational principle. This beautiful method was the result of several centuries of collective effort, and is the highlight of particle dynamics. Variational principles also provide the basis for all the other global approaches just mentioned and for all the further descriptions of motion that we will explore afterwards.





## MEASURING CHANGE WITH ACTION

Motion can be described by numbers. For a single particle, the relations between the spatial and temporal coordinates describe the motion. The realization that expressions like  $(x(t), y(t), z(t))$  could be used to describe the path of a moving particle was a milestone in the development of modern physics.

We can go further. Motion is a type of *change*. And this change can itself be usefully described by numbers. In fact, change can be measured by a single number. This realization was the next important milestone. Physicists took almost two centuries of attempts to uncover the way to describe change. As a result, the quantity that measures change has a strange name: it is called (*physical*) *action*.<sup>\*</sup> To remember the connection of ‘action’ with change, just think about a Hollywood film: a lot of action means a large amount of change.

Imagine taking two snapshots of a system at different times. How could you define the amount of change that occurred in between? When do things change a lot, and when do they change only a little? First of all, a system with many moving parts shows a lot of change. So it makes sense that the action of a system composed of independent subsystems should be the sum of the actions of these subsystems. And systems with large speeds, such as the explosions shown in [Figure 147](#), show larger change than systems at lower speed.

Secondly, change often – but not always – builds up over time; in other cases, recent change can compensate for previous change, as in a pendulum. Change can thus increase or decrease with time.

Thirdly, for a system in which motion is stored, transformed or shifted from one subsystem to another, especially when kinetic energy is stored or changed to potential energy,

---

<sup>\*</sup> Note that this ‘action’ is not the same as the ‘action’ appearing in statements such as ‘every action has an equal and opposite reaction’. This last usage, coined by Newton for certain forces, has not stuck; therefore the term has been recycled. After Newton, the term ‘action’ was first used with an intermediate meaning, before it was finally given the modern meaning used here. This last meaning is the only meaning used in this text.

Another term that has been recycled is the ‘principle of least action’. In old books it used to have a different meaning from the one in this chapter. Nowadays, it refers to what used to be called *Hamilton’s principle* in the Anglo-Saxon world, even though it is (mostly) due to others, especially Leibniz. The old names and meanings are falling into disuse and are not continued here.

Behind these shifts in terminology is the story of an intense two-centuries-long attempt to describe motion with so-called *extremal* or *variational principles*: the objective was to complete and improve the work initiated by Leibniz. These principles are only of historical interest today, because all are special cases of the principle of least action described here.



FIGURE 146 Giuseppe/Joseph Lagrangia/Lagrange (1736–1813).



FIGURE 147 Physical action measures change: an example of process with large action value (© Christophe Blanc).

change is smaller than for a system where all systems move freely.

The mentioned properties imply that the natural measure of change is the average difference between kinetic and potential energy multiplied by the elapsed time. This quantity has all the right properties: it is the sum of the corresponding quantities for all sub-systems if these are independent; it generally increases with time (unless the evolution compensates for something that happened earlier); and it decreases if the system transforms motion into potential energy.

Challenge 391 e

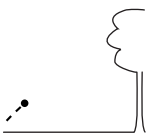


TABLE 30 Some action values for changes either observed or imagined.

CHANGE	APPROXIMATE ACTION VALUE
Smallest measurable change in nature	$0.5 \cdot 10^{-34}$ Js
Exposure of photographic film	$1.1 \cdot 10^{-34}$ Js to $10^{-9}$ Js
Wing beat of a fruit fly	c. 1 pJs
Flower opening in the morning	c. 1 nJs
Getting a red face	c. 10 mJs
Held versus dropped glass	c. 0.8 Js
Tree bent by the wind from one side to the other	c. 500 Js
Making a white rabbit vanish by 'real' magic	c. 100 PJs
Hiding a white rabbit	c. 0.1 Js
Maximum brain change in a minute	c. 5 Js
Levitating yourself within a minute by 1 m	c. 40 kJs
Car crash	c. 2 kJs
Birth	c. 2 kJs
Change due to a human life	c. 1 EJs
Driving car stops within the blink of an eye	c. 20 kJs
Large earthquake	c. 1 PJs
Driving car disappears within the blink of an eye	c. 1 ZJs
Sunrise	c. 0.1 ZJs
Gamma ray burster before and after explosion	c. $10^{46}$ Js
Universe after one second has elapsed	undefined and undefinable

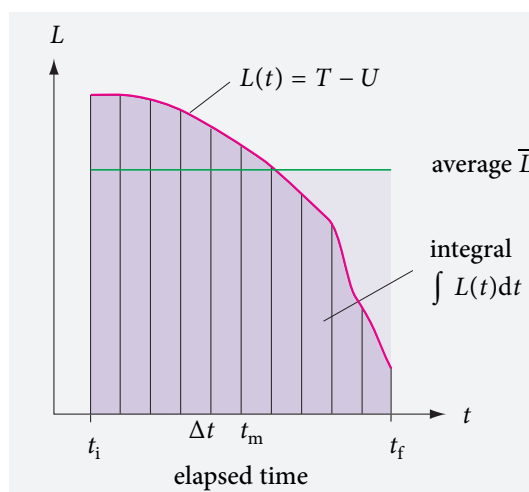


FIGURE 148 Defining a total change or action as an accumulation (addition, or integral) of small changes or actions over time.

Thus the (physical) *action*  $S$ , measuring the change in a system, is defined as

$$S = \bar{L} \cdot (t_f - t_i) = \overline{T - U} \cdot (t_f - t_i) = \int_{t_i}^{t_f} (T - U) dt = \int_{t_i}^{t_f} L dt, \quad (68)$$





Page 148 where  $T$  is the kinetic energy,  $U$  the potential energy we already know,  $L$  is the difference between these, and the overbar indicates a time average. The quantity  $L$  is called the *Lagrangian (function)* of the system,\* describes what is being added over time, whenever things change. The sign  $\int$  is a stretched 'S', for 'sum', and is pronounced 'integral of'. In intuitive terms it designates the operation (called *integration*) of adding up the values of a varying quantity in infinitesimal time steps  $dt$ . The initial and the final times are written below and above the integration sign, respectively. Figure 148 illustrates the idea: the integral is simply the size of the dark area below the curve  $L(t)$ .

Challenge 392 e Mathematically, the integral of the curve  $L(t)$  is defined as

$$\int_{t_i}^{t_f} L(t) dt = \lim_{\Delta t \rightarrow 0} \sum_{m=i}^f L(t_m) \Delta t = \bar{L} \cdot (t_f - t_i) . \quad (69)$$

In other words, the *integral* is the limit, as the time slices get smaller, of the sum of the areas of the individual rectangular strips that approximate the function. Since the  $\sum$  sign also means a sum, and since an infinitesimal  $\Delta t$  is written  $dt$ , we can understand the notation used for integration. Integration is a sum over slices. The notation was developed by Gottfried Leibniz to make exactly this point. Physically speaking, the integral of the Lagrangian measures the total *effect* that  $L$  builds up over time. Indeed, action is called 'effect' in some languages, such as German. The effect that builds up is the total change in the system.

In short, *the integral of the Lagrangian, the action, measures the total change that occurs in a system.* Physical action is total change. Action, or change, is the integral of the Lagrangian over time. The unit of action, and thus of change, is the unit of energy (the Joule) times the unit of time (the second). In physics, change is measured in Js. A large value means a big change. Table 30 shows some values of actions.

To understand the definition of action in more detail, we will start with the simplest case: a system for which the potential energy is zero, such as a particle moving freely. Obviously, the higher the kinetic energy is, the more change there is. Also, if we observe the particle at two instants, the more distant they are the larger the change. This is not surprising.

Next, we explore a single particle moving in a potential. For example, a falling stone loses potential energy in exchange for a gain in kinetic energy. The more energy is exchanged, the more change there is. Hence the minus sign in the definition of  $L$ . If we explore a particle that is first thrown up in the air and then falls, the curve for  $L(t)$  first is below the times axis, then above. We note that the definition of integration makes us count the grey surface *below* the time axis *negatively*. Change can thus be negative, and be compensated by subsequent change, as expected.

To measure change for a system made of several independent components, we simply

\* It is named after Giuseppe Lodovico Lagrangia (b. 1736 Torino, d. 1813 Paris), better known as Joseph Louis Lagrange. He was the most important mathematician of his time; he started his career in Turin, then worked for 20 years in Berlin, and finally for 26 years in Paris. Among other things he worked on number theory and analytical mechanics, where he developed most of the mathematical tools used nowadays for calculations in classical mechanics and classical gravitation. He applied them successfully to many motions in the solar system.

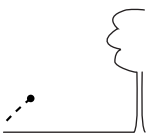




TABLE 31 Some observed action values for processes in nature.

SYSTEM AND PROCESS	ACTION VALUE
Smallest measurable action	$1.1 \cdot 10^{-34}$ Js
<i>Light</i>	
Smallest blackening of photographic film	$c. 10^{-33}$ Js
Photographic flash	$c. 10^{-17}$ Js
<i>Electricity</i>	
Electron ejected from atom or molecule	$c. 10^{-33}$ Js
Current flow in lightning bolt	$c. 10^4$ Js
<i>Materials</i>	
Tearing apart two neighbouring iron atoms	$c. 10^{-33}$ Js
Breaking a steel bar	$c. 10^1$ Js
<i>Chemistry</i>	
Atom collision in liquid at room temperature	$c. 10^{-33}$ Js
Smelling one molecule	$c. 10^{-31}$ Js
Burning fuel in a cylinder in an average car engine explosion	$c. 10^4$ Js
<i>Life</i>	
Air molecule hitting eardrum	$c. 10^{-32}$ Js
Ovule fertilization	$c. 10^{-20}$ Js
Cell division	$c. 10^{-15}$ Js
Fruit fly's wing beat	$c. 10^{-10}$ Js
Person walking one body length	$c. 10^2$ Js
<i>Nuclei and stars</i>	
Single nuclear fusion reaction in star	$c. 10^{-15}$ Js
Explosion of gamma-ray burster	$c. 10^{46}$ Js

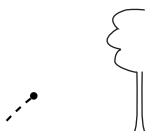
add all the kinetic energies and subtract all the potential energies. This technique allows us to define actions for gases, liquids and solid matter. Even if the components interact, we still get a sensible result. In short, action is an *additive* quantity.

Physical action thus measures, in a single number, the change observed in a system between two instants of time. This is valid for all observations: an explosion, a caress or a colour change. Change is measured in Js. We will discover later that describing change with a single number is also possible in relativity and quantum theory. Any change going on in any system of nature, be it transport, transformation or growth, can be measured with a single number.

Page 19

### THE PRINCIPLE OF LEAST ACTION

We now have a precise measure of change, which, as it turns out, allows a simple and powerful description of motion. In nature, the change happening between two instants is



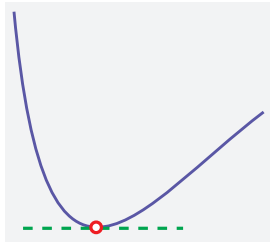


FIGURE 149 The minimum of a curve has vanishing slope.

always the *smallest* possible. *In nature, action is minimal.*\* Of all possible motions, nature always chooses for which the change is *minimal*. Let us study a few examples.

Challenge 393 e

In the simple case of a free particle, when no potentials are involved, the principle of minimal action implies that the particle moves in a *straight* line with *constant* velocity. All other paths would lead to larger actions. Can you verify this?

Challenge 394 e

When gravity is present, a thrown stone flies along a parabola (or more precisely, along an ellipse) because any other path, say one in which the stone makes a loop in the air, would imply a *larger* action. Again you might want to verify this for yourself.

All observations support this simple and basic statement: things always move in a way that produces the smallest possible value for the action. This statement applies to the full path and to any of its segments. Bertrand Russell called it the ‘law of cosmic laziness’.

It is customary to express the idea of minimal change in a different way. The action varies when the path is varied. The actual path is the one with the smallest action. You will recall from school that at a minimum the derivative of a quantity vanishes: a minimum has a horizontal slope. In the present case, we do not vary a quantity, but a complete path; hence we do not speak of a derivative or slope, but of a variation. It is customary to write the variation of action as  $\delta S$ . The *principle of least action* thus states:

$$\triangleright \text{The actual trajectory between specified end points satisfies } \delta S = 0. \quad (70)$$

Mathematicians call this a *variational principle*. Note that the end points have to be specified: we have to compare motions with the *same* initial and final situations.

Before discussing the principle further, we can check that it is equivalent to the evolution equation.\*\* To do this, we can use a standard procedure, part of the so-called *calculus of variations*. The condition  $\delta S = 0$  implies that the action, i.e., the area under the curve

Ref. 174

\* In fact, in some macroscopic situations the action can be a saddle point, so that the snobbish form of the principle is that the action is ‘stationary’. In contrast to what is often heard, the action is *never* a maximum. Moreover, for motion on small (infinitesimal) scales, the action is always a minimum. The mathematical condition of vanishing variation, given below, encompasses all these details.

Page 187

\*\* For those interested, here are a few comments on the equivalence of Lagrangians and evolution equations. First of all, Lagrangians do not exist for non-conservative, or *dissipative* systems. We saw that there is no potential for any motion involving *friction* (and more than one dimension); therefore there is no action in these cases. One approach to overcome this limitation is to use a generalized formulation of the principle of least action. Whenever there is no potential, we can express the *work* variation  $\delta W$  between different trajectories  $x_i$  as

$$\delta W = \sum_i m_i \ddot{x}_i \delta x_i. \quad (71)$$



in Figure 148, is a minimum. A little bit of thinking shows that if the Lagrangian is of the form  $L(x_n, v_n) = T(v_n) - U(x_n)$ , then

$$\frac{d}{dt} \left( \frac{\partial T}{\partial v_n} \right) = - \frac{\partial U}{\partial x_n} \quad (73)$$

where  $n$  counts all coordinates of all particles.\* For a single particle, these *Lagrange's*

Motion is then described in the following way:

$$\triangleright \text{The actual trajectory satisfies } \int_{t_i}^{t_f} (\delta T + \delta W) dt = 0 \quad \text{provided } \delta x(t_i) = \delta x(t_f) = 0. \quad (72)$$

Challenge 395 ny

The quantity being varied has no name; it represents a generalized notion of change. You might want to check that it leads to the correct evolution equations. Thus, although *proper* Lagrangian descriptions exist only for *conservative* systems, for dissipative systems the principle can be generalized and remains useful.

Many physicists will prefer another approach. What a mathematician calls a generalization is a special case for a physicist: the principle (72) hides the fact that *all* friction results from the usual principle of minimal action, if we include the complete microscopic details. There is no friction in the microscopic domain. Friction is an approximate, macroscopic concept.

Nevertheless, more mathematical viewpoints are useful. For example, they lead to interesting limitations for the use of Lagrangians. These limitations, which apply only if the world is viewed as purely classical – which it isn't – were discovered about a hundred years ago. In those times, computers were not available, and the exploration of new calculation techniques was important. Here is a summary.

Ref. 175

The coordinates used in connection with Lagrangians are not necessarily the Cartesian ones. *Generalized* coordinates are especially useful when there are *constraints* on the motion. This is the case for a pendulum, where the weight always has to be at the same distance from the suspension, or for an ice skater, where the skate has to move in the direction in which it is pointing. Generalized coordinates may even be mixtures of positions and momenta. They can be divided into a few general types.

Page 303

Generalized coordinates are called *holonomic-scleronomic* if they are related to Cartesian coordinates in a fixed way, independently of time: physical systems described by such coordinates include the pendulum and a particle in a potential. Coordinates are called *holonomic-rheonomic* if the dependence involves time. An example of a rheonomic systems would be a pendulum whose length depends on time. The two terms rheonomic and scleronomic are due to Ludwig Boltzmann. These two cases, which concern systems that are only described by their geometry, are grouped together as *holonomic systems*. The term is due to Heinrich Hertz.

Vol. III, page 85

The more general situation is called *anholonomic*, or *nonholonomic*. Lagrangians work well only for holonomic systems. Unfortunately, the meaning of the term 'nonholonomic' has changed. Nowadays, the term is also used for certain rheonomic systems. The modern use calls nonholonomic any system which involves velocities. Therefore, an ice skater or a rolling disc is often called a nonholonomic system. Care is thus necessary to decide what is meant by nonholonomic in any particular context.

Even though the use of Lagrangians, and of action, has its limitations, these need not bother us at microscopic level, since microscopic systems are always conservative, holonomic and scleronomic. At the fundamental level, evolution equations and Lagrangians are indeed equivalent.

\* The most general form for a Lagrangian  $L(q_n, \dot{q}_n, t)$ , using generalized holonomic coordinates  $q_n$ , leads to Lagrange equations of the form

$$\frac{d}{dt} \left( \frac{\partial L}{\partial \dot{q}_n} \right) = \frac{\partial L}{\partial q_n}. \quad (74)$$

In order to deduce these equations, we also need the relation  $\delta \dot{q} = d/dt(\delta q)$ . This relation is valid only for *holonomic* coordinates introduced in the previous footnote and explains their importance.

Ref. 176

It should also be noted that the Lagrangian for a moving system is not unique; however, the study of how the various Lagrangians for a given moving system are related is not part of this walk.

By the way, the letter  $q$  for position and  $p$  for momentum were introduced in physics by the mathemati-



Challenge 397 e *equations of motion* reduce to

$$m\mathbf{a} = -\nabla U . \quad (75)$$

This is the evolution equation: it says that the force acting on a particle is the gradient of the potential energy  $U$ . The principle of least action thus implies the equation of motion. (Can you show the converse, which is also correct?)

Challenge 398 s

In other words, *all systems evolve in such a way that the change or action is as small as possible*. Nature is economical. Nature is thus the opposite of a Hollywood thriller, in which the action is maximized; nature is more like a wise old man who keeps his actions to a minimum.

The principle of minimal action states that the actual trajectory is the one for which the *average* of the Lagrangian over the whole trajectory is minimal (see Figure 148). Nature is a Dr. Dolittle. Can you verify this? This viewpoint allows one to deduce Lagrange's equations (73) directly.

Challenge 399 ny

The principle of least action distinguishes the actual trajectory from all other imaginable ones. This observation led Leibniz to his famous interpretation that the actual world is the 'best of all possible worlds.'<sup>\*</sup> We may dismiss this as metaphysical speculation, but we should still be able to feel the fascination of the issue. Leibniz was so excited about the principle of least action because it was the first time that actual observations were distinguished from all other imaginable possibilities. For the first time, the search for reasons why things are the way they are became a part of physical investigation. Could the world be different from what it is? In the principle of least action, we have a hint of a negative answer. (What do you think?) The final answer will emerge only in the last part of our adventure.

Challenge 400 s

## LAGRANGIANS AND MOTION

Ref. 178

“Never confuse movement with action.”  
Ernest Hemingway

Systems evolve by minimizing change. Change, or action, is the time integral of the Lagrangian. As a way to describe motion, the Lagrangian has several advantages over the evolution equation. First of all, the Lagrangian is usually more *compact* than writing the corresponding evolution equations. For example, only *one* Lagrangian is needed for one system, however many particles it includes. One makes fewer mistakes, especially sign mistakes, as one rapidly learns when performing calculations. Just try to write down the evolution equations for a chain of masses connected by springs; then compare the effort with a derivation using a Lagrangian. (The system is often studied because it behaves like a chain of atoms.) We will encounter another example shortly: David Hilbert took only a few weeks to deduce the equations of motion of general relativity using a Lagrangian, whereas Albert Einstein had worked for ten years searching for them directly.

Challenge 401 ny

In addition, the description with a Lagrangian is valid with *any* set of coordinates describing the objects of investigation. The coordinates do not have to be Cartesian; they

cian Carl Jacobi (b. 1804 Potsdam, d. 1851 Berlin).

<sup>\*</sup> This idea was ridiculed by the French philosopher Voltaire (1694–1778) in his lucid writings, notably in the brilliant book *Candide*, written in 1759, and still widely available.

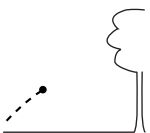


TABLE 32 Some Lagrangians.

SYSTEM	LAGRANGIAN	QUANTITIES
Free, non-relativistic mass point	$L = \frac{1}{2}mv^2$	mass $m$ , speed $v = dx/dt$
Particle in potential	$L = \frac{1}{2}mv^2 - m\phi(x)$	gravitational potential $\phi$
Mass on spring	$L = \frac{1}{2}mv^2 - \frac{1}{2}kx^2$	elongation $x$ , spring constant $k$
Mass on frictionless table attached to spring	$L = \frac{1}{2}mv^2 - k(x^2 + y^2)$	spring constant $k$ , coordinates $x, y$
Chain of masses and springs (simple model of atoms in a linear crystal)	$L = \frac{1}{2}m \sum v_i^2 + \frac{1}{2}m\omega^2 \sum_{i,j}(x_i - x_j)^2$	coordinates $x_i$ , lattice frequency $\omega$
Free, relativistic mass point	$L = -mc^2 \sqrt{1 - v^2/c^2}$	mass $m$ , speed $v$ , speed of light $c$

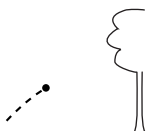
can be chosen as one prefers: cylindrical, spherical, hyperbolic, etc. These so-called *generalized coordinates* allow one to rapidly calculate the behaviour of many mechanical systems that are in practice too complicated to be described with Cartesian coordinates. For example, for programming the motion of robot arms, the angles of the joints provide a clearer description than Cartesian coordinates of the ends of the arms. Angles are non-Cartesian coordinates. They simplify calculations considerably: the task of finding the most economical way to move the hand of a robot from one point to another can be solved much more easily with angular variables.

More importantly, the Lagrangian allows one to quickly deduce the essential properties of a system, namely, its *symmetries* and its *conserved quantities*. We will develop this important idea shortly, and use it regularly throughout our walk.

Finally, the Lagrangian formulation can be generalized to encompass *all types of interactions*. Since the concepts of kinetic and potential energy are general, the principle of least action can be used in electricity, magnetism and optics as well as mechanics. The principle of least action is central to general relativity and to quantum theory, and allows one to easily relate both fields to classical mechanics.

As the principle of least action became well known, people applied it to an ever-increasing number of problems. Today, Lagrangians are used in everything from the study of elementary particle collisions to the programming of robot motion in artificial intelligence. However, we should not forget that despite its remarkable simplicity and usefulness, the Lagrangian formulation is *equivalent* to the evolution equations. It is neither more general nor more specific. In particular, it is *not an explanation* for any type of motion, but only a different view of it. In fact, the search of a new physical 'law' of motion is *just* the search for a new Lagrangian. This makes sense, as the description of nature always requires the description of change. Change in nature is always described by actions and Lagrangians.

The principle of least action states that the action is minimal when the end point of the motion, and in particular the time between them, are fixed. It is less well known that the reciprocal principle also holds: if the action is kept fixed, the elapsed time is maximal.



Challenge 403 ny Can you show this?

Even though the principle of least action is not an explanation of motion, it somehow calls for one. We need some patience, though. *Why* nature follows the principle of least action, and *how* it does so, will become clear when we explore quantum theory.

### WHY IS MOTION SO OFTEN BOUNDED?

“The optimist thinks this is the best of all possible worlds, and the pessimist knows it.”  
Robert Oppenheimer

Ref. 179

Looking around ourselves on Earth or in the sky, we find that matter is not evenly distributed. Matter tends to be near other matter: it is lumped together in *aggregates*. Some major examples of aggregates are listed in [Figure 150](#) and [Table 33](#). All aggregates have mass and size. In the mass–size diagram of [Figure 150](#), both scales are logarithmic. One notes three straight lines: a line  $m \sim l$  extending from the Planck mass\* upwards, via black holes, to the universe itself; a line  $m \sim 1/l$  extending from the Planck mass downwards, to the lightest possible aggregate; and the usual matter line with  $m \sim l^3$ , extending from atoms upwards, via everyday objects, the Earth to the Sun. The first of the lines, the black hole limit, is explained by general relativity; the last two, the aggregate limit and the common matter line, by quantum theory.\*\*

The aggregates outside the common matter line also show that the stronger the interaction that keeps the components together, the smaller the aggregate. But why is matter mainly found in lumps?

First of all, aggregates form because of the existence of *attractive* interactions between objects. Secondly, they form because of *friction*: when two components approach, an aggregate can only be formed if the released energy can be changed into heat. Thirdly, aggregates have a finite size because of *repulsive* effects that prevent the components from collapsing completely. Together, these three factors ensure that bound motion is much more common than unbound, ‘free’ motion.

Vol. IV, page 113

Challenge 404 s

Only three types of attraction lead to aggregates: gravity, the attraction of electric charges, and the strong nuclear interaction. Similarly, only three types of repulsion are observed: rotation, pressure, and the Pauli exclusion principle (which we will encounter later on). Of the nine possible combinations of attraction and repulsion, not all appear in nature. Can you find out which ones are missing from [Figure 150](#) and [Table 33](#), and why?

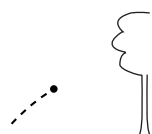
Challenge 405 ny

Together, attraction, friction and repulsion imply that change and action are minimized when objects come and stay together. The principle of least action thus implies the stability of aggregates. By the way, formation history also explains why so many aggregates *rotate*. Can you tell why?

But why does friction exist at all? And why do attractive and repulsive interactions exist? And why is it – as it would appear from the above – that in some distant past matter was *not* found in lumps? In order to answer these questions, we must first study

\* The Planck mass is given by  $m_{\text{pl}} = \sqrt{\hbar c/G} = 21.767(16) \mu\text{g}$ .

\*\* [Figure 150](#) suggests that domains beyond physics exist; we will discover later on that this is not the case, as mass and size are not definable in those domains.



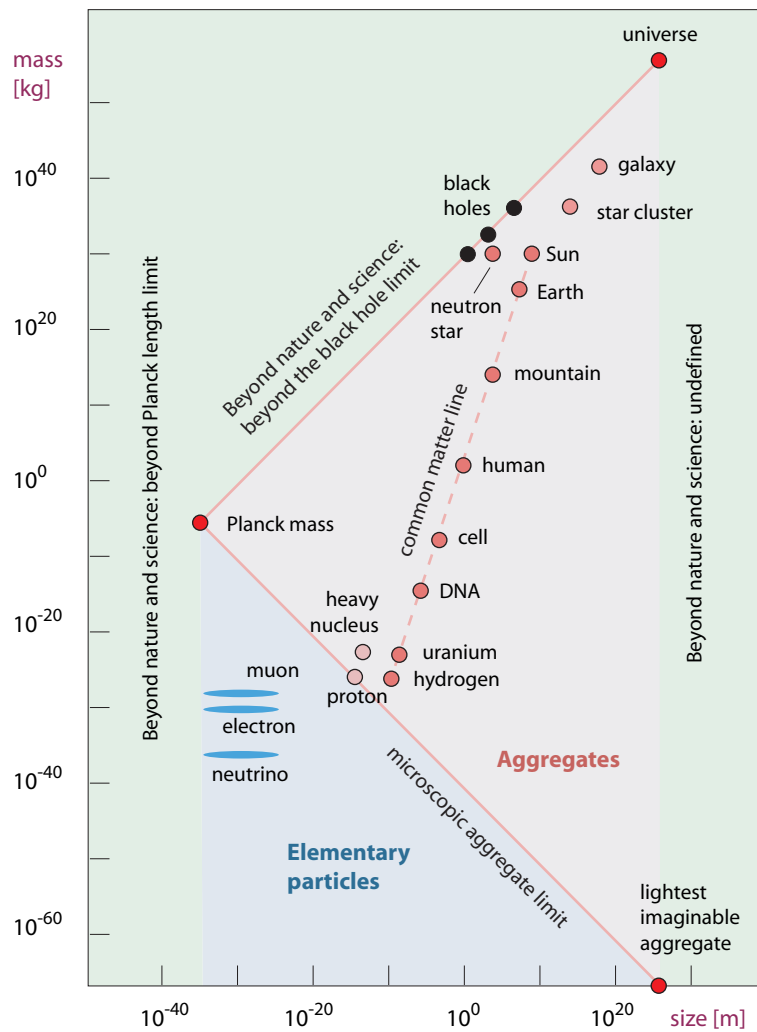
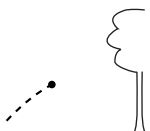


FIGURE 150 Elementary particles and aggregates found in nature.

another global property of motion: symmetry.

TABLE 33 Some major aggregates observed in nature.

AGGREGATE	SIZE (DIAMETER)	OBS. NUM.	CONSTITUENTS
<b>Gravitationally bound aggregates</b>			
Matter across universe	c. 100 Ym	1	superclusters of galaxies, hydrogen and helium atoms
Quasar	$10^{12}$ to $10^{14}$ m	$20 \cdot 10^6$	baryons and leptons
Supercluster of galaxies	c. 3 Ym	$10^7$	galaxy groups and clusters
Galaxy cluster	c. 60 Zm	$25 \cdot 10^9$	10 to 50 galaxies
Galaxy group or cluster	c. 240 Zm		50 to over 2000 galaxies





AGGREGATE	SIZE (DIAMETER)	OBS. NUM.	CONSTITUENTS
Our local galaxy group	50 Zm	1	c. 40 galaxies
General galaxy	0.5 to 2 Zm	$3.5 \cdot 10^{12}$	$10^{10}$ to $3 \cdot 10^{11}$ stars, dust and gas clouds, probably solar systems
Our galaxy	1.0(0.1) Zm	1	$10^{11}$ stars, dust and gas clouds, solar systems
Interstellar clouds	up to 15 Em	$\gg 10^5$	hydrogen, ice and dust
Solar system <sup>a</sup>	unknown	> 400	star, planets
Our solar system	30 Pm	1	Sun, planets (Pluto's orbit's diameter: 11.8 Tm), moons, planetoids, comets, asteroids, dust, gas
Oort cloud	6 to 30 Pm	1	comets, dust
Kuiper belt	60 Tm	1	planetoids, comets, dust
Star <sup>b</sup>	10 km to 100 Gm	$10^{22\pm 1}$	ionized gas: protons, neutrons, electrons, neutrinos, photons
Our star, the Sun	1.39 Gm		
Planet <sup>a</sup> (Jupiter, Earth)	143 Mm, 12.8 Mm	> 400	solids, liquids, gases; in particular, heavy atoms
Planetoids (Varuna, etc)	50 to 1 000 km	> 100 (est. $10^9$ )	solids
Moons	10 to 1 000 km	> 50	solids
neutron stars	10 km	> 1000	mainly neutrons
<b>Electromagnetically bound aggregates<sup>c</sup></b>			
Dwarf planets, minor planets, asteroids <sup>d</sup>	1 m to 2400 km	> $10^6$	( $10^9$ estimated) solids, usually monolithic
Comets	10 cm to 50 km	> $10^9$	( $10^{12}$ possible) ice and dust
Mountains, solids, liquids, gases, cheese	1 nm to > 100 km	n.a.	molecules, atoms
Animals, plants, kefir	5 $\mu$ m to 1 km	$10^{26\pm 2}$	organs, cells
brain, human	0.2 m	$10^{10}$	neurons and other cell types
Cells:		$10^{31\pm 1}$	organelles, membranes, molecules
smallest ( <i>Nanoarchaeum equitans</i> )	c. 400 nm		molecules
amoeba	c. 600 $\mu$ m		molecules
largest (whale nerve, single-celled plants)	c. 30 m		molecules
Molecules:		$10^{78\pm 2}$	atoms
H <sub>2</sub>	c. 50 pm	$10^{72\pm 2}$	atoms
DNA (human)	2 m (total per cell)	$10^{21}$	atoms
Atoms, ions	30 pm to 300 pm	$10^{80\pm 2}$	electrons and nuclei
<b>Aggregates bound by the weak interaction<sup>c</sup></b>			
None			



AGGREGATE	SIZE (DIAMETER)	OBS. NUM.	CONSTITUENTS
<b>Aggregates bound by the strong interaction <sup>c</sup></b>			
Nucleus	0.9 to > 7 fm	10 <sup>79±2</sup>	nucleons
Nucleon (proton, neutron)	0.9 fm	10 <sup>80±2</sup>	quarks
Mesons	c. 1 fm	n.a.	quarks
Neutron stars: see above			

Ref. 180 *a.* Only in 1994 was the first evidence found for objects circling stars other than our Sun; of over 400 *extra-solar planets* found so far, most are found around F, G and K stars, including neutron stars. For example, three objects circle the pulsar PSR 1257+12, and a matter ring circles the star  $\beta$  Pictoris. The objects seem to be dark stars, brown dwarfs or large gas planets like Jupiter. Due to the limitations of observation systems, none of the systems found so far form solar systems of the type we live in. In fact, only a few Earth-like planets have been found so far.

Vol. II, page 225

Vol. V, page 260

Ref. 181

*b.* The Sun is among the brightest 7 % of stars. Of all stars, 80 % are red M dwarfs, 8 % are orange K dwarfs, and 5 % are white D dwarfs: these are all faint. Almost all stars visible in the night sky belong to the bright 7 %. Some of these are from the rare blue O class or blue B class (such as Spica, Regulus and Rigel); 0.7 % consist of the bright, white A class (such as Sirius, Vega and Altair); 2 % are of the yellow-white F class (such as Canopus, Procyon and Polaris); 3.5 % are of the yellow G class (like Alpha Centauri, Capella or the Sun). Exceptions include the few visible K giants, such as Arcturus and Aldebaran, and the rare M supergiants, such as Betelgeuse and Antares. More on stars later on.

*c.* For more details on *microscopic* aggregates, see the table of composites..

*d.* It is estimated that there are up to 10<sup>20</sup> *small solar system bodies* (asteroids, planetoids, minor planets, meteoroids) that are heavier than 100 kg in the solar system. Incidentally, no asteroids between Mercury and the Sun – the hypothetical *Vulcanoids* – have been found so far.

### CURIOSITIES AND FUN CHALLENGES ABOUT LAGRANGIANS

When Lagrange published his book *Mécanique analytique*, in 1788, it formed one of the high points in the history of mechanics. He was proud of having written a systematic exposition of mechanics without a single figure. Obviously the book was difficult to read and was not a sales success. Therefore his methods took another generation to come into general use.

\* \*

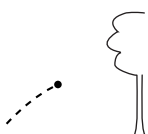
Challenge 406 s

Given that action is the basic quantity describing motion, we can define energy as action per unit time, and momentum as action per unit distance. The *energy* of a system thus describes how much it changes over time, and the *momentum* how much it changes over distance. What are angular momentum and rotational energy?

\* \*

Challenge 407 s

‘In nature, effects of telekinesis or prayer are impossible, as in most cases the change inside the brain is much smaller than the change claimed in the outside world.’ Is this argument correct?



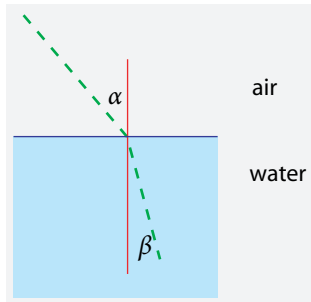


FIGURE 151 Refraction of light is due to travel-time optimization.

\* \*

In Galilean physics, the Lagrangian is the difference between kinetic and potential energy. Later on, this definition will be generalized in a way that sharpens our understanding of this distinction: the Lagrangian becomes the difference between a term for free particles and a term due to their interactions. In other words, particle motion is a continuous compromise between what the particle would do if it were free and what other particles want it to do. In this respect, particles behave a lot like humans beings.

\* \*

Challenge 408 ny Explain: why is  $T + U$  constant, whereas  $T - U$  is minimal?

\* \*

In nature, the sum  $T + U$  of kinetic and potential energy is *constant* during motion (for closed systems), whereas the average of the difference  $T - U$  is *minimal*. Is it possible to deduce, by combining these two facts, that systems tend to a state with minimum potential energy?

Challenge 409 ny

\* \*

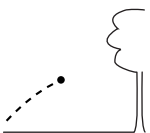
Ref. 182

Another minimization principle can be used to understand the construction of animal bodies, especially their size and the proportions of their inner structures. For example, the heart pulse and breathing frequency both vary with animal mass  $m$  as  $m^{-1/4}$ , and the dissipated power varies as  $m^{3/4}$ . It turns out that such exponents result from three properties of living beings. First, they transport energy and material through the organism via a branched network of vessels: a few large ones, and increasingly many smaller ones. Secondly, the vessels all have the same minimum size. And thirdly, the networks are optimized in order to minimize the energy needed for transport. Together, these relations explain many additional scaling rules; they might also explain why animal lifespan scales as  $m^{-1/4}$ , or why most mammals have roughly the same number of heart beats in a lifetime.

Ref. 183

A competing explanation, using a different minimization principle, states that quarter powers arise in any network built in order that the flow arrives to the destination by the most direct path.

\* \*



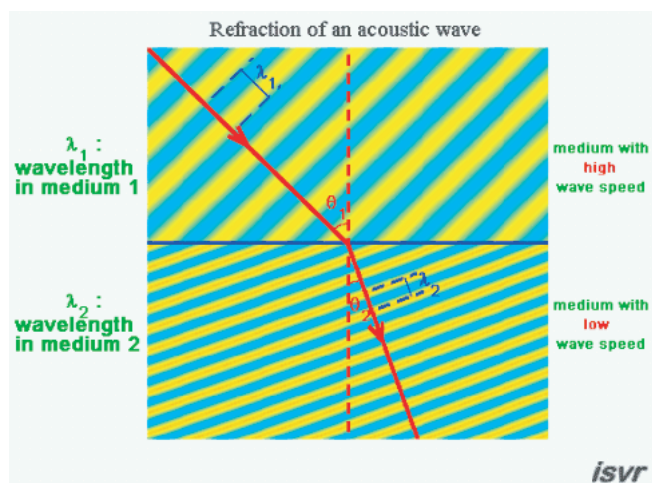


FIGURE 152 A visualisation of refraction (QuickTime film © ISVR, University of Southampton)

The minimization principle for the motion of light is even more beautiful: light always takes the path that requires the shortest travel time. It was known long ago that this idea describes exactly how light changes direction when it moves from air to water. In water, light moves more slowly; the speed ratio between air and water is called the *refractive index* of water. The refractive index, usually abbreviated  $n$ , is material-dependent. The value for water is about 1.3. This speed ratio, together with the minimum-time principle, leads to the ‘law’ of refraction, a simple relation between the sines of the two angles. Can you deduce it? (In fact, the exact definition of the refractive index is with respect to vacuum, not to air. But the difference is negligible: can you imagine why?)

Challenge 410 s

Challenge 411 s

For diamond, the refractive index is 2.4. The high value is one reason for the sparkle of diamonds cut with the 57-face *brilliant* cut. Can you think of some other reasons?

Challenge 412 s

\* \*

Can you confirm that all the mentioned minimization principles – that for the growth of trees, that for the networks inside animals, that for the motion of light – are special cases of the principle of least action? In fact, this is the case for *all* known minimization principles in nature. Each of them, like the principle of least action, is a principle of least change.

Challenge 413 s

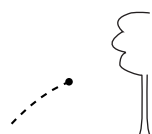
\* \*

In Galilean physics, the value of the action depends on the speed of the observer, but not on his position or orientation. But the action, when properly defined, should *not* depend on the observer. All observers should agree on the value of the observed change. Only special relativity will fulfil the requirement that action be independent of the observer’s speed. How will the relativistic action be defined?

Challenge 414 s

\* \*

Measuring all the change that is going on in the universe presupposes that the universe



Challenge 415 s is a physical system. Is this the case?

\* \*

Ref. 184 One motion for which action is particularly well minimized in nature is dear to us: walking. Extensive research efforts try to design robots which copy the energy saving functioning and control of human legs. For an example, see the website by Tao Geng at [cswww.essex.ac.uk/tgeng/research.html](http://cswww.essex.ac.uk/tgeng/research.html).

\* \*

Challenge 416 d Can you prove the following integration challenge?

$$\int_0^{\varphi} \sec t \, dt = \ln \tan\left(\frac{\pi}{4} + \frac{\varphi}{2}\right) \quad (76)$$

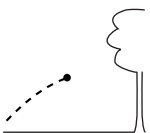
\* \*

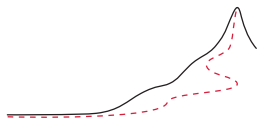
Challenge 417 s What is the shape of the ideal halfpipe for skateboarding? What does 'ideal' imply? Which requirement leads to a *cycloid*? Which requirement speaks against a *cycloid*?

#### SUMMARY ON ACTION

Systems move by minimizing change. Change, or action, is the time average of kinetic energy minus potential energy. The statement 'motion minimizes change' contains motion's predictability, its continuity, and its simplicity.

In the next sections we show that change minimization also implies observer-invariance, conservation, mirror-invariance, reversibility and relativity of motion.





Ref. 190

“Am Anfang war die Symmetrie.\*”  
Werner Heisenberg

The second way to describe motion globally is to describe it in such a way that *all* observers agree. Now, whenever an observation stays the same when changing from one observer to another, we call the observation *symmetric*.

*Symmetry is invariance after change.* Change of observer or point of view is one such possible change, as can be some change operated on the observation itself. For example, a forget-me-not flower, shown in [Figure 153](#), is symmetrical because it looks the same after turning it, or after turning around it, by 72 degrees; many fruit tree flowers have the same symmetry. One also says that under certain changes of viewpoint the flower has an *invariant property*, namely its shape. If many such viewpoints are possible, one talks about a *high* symmetry, otherwise a *low* symmetry. For example, a four-leaf clover has a higher symmetry than a usual, three-leaf one. In physics, the viewpoints are often called *frames of reference*.

Ref. 191

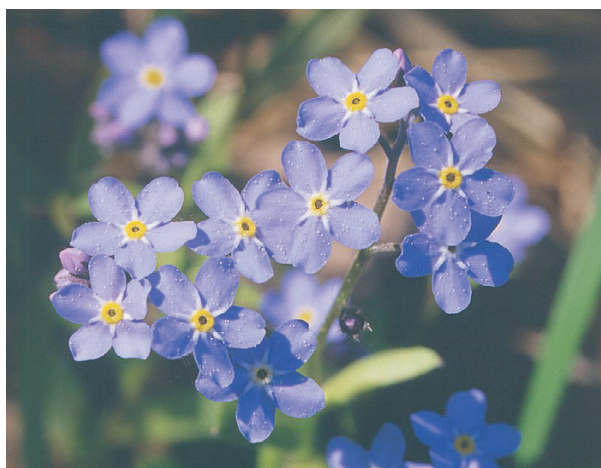
When we speak about symmetry in everyday life, in architecture or in the arts we usually mean mirror symmetry, rotational symmetry or some combination. These are *geometric symmetries*. Like all symmetries, geometric symmetries imply invariance under specific change operations. The complete list of geometric symmetries is known for a long time. [Table 34](#) gives an overview of the basic types. [Figure 154](#) and [Figure 155](#) give some important examples. Additional geometric symmetries include *colour symmetries*, where colours are exchanged, and *spin groups*, where symmetrical objects do not contain only points but also spins, with their special behaviour under rotations. Also combinations with scale symmetry, as they appear in fractals, and variations on curved backgrounds are extension of the basic table.

Challenge 418 s

A *high* symmetry means that *many* possible changes leave an observation invariant. At first sight, not many objects or observations in nature seem to be symmetrical: after all, geometric symmetry is more the exception than the rule. But this is a fallacy. On the contrary, we can deduce that nature as a whole is symmetric from the simple fact that we have the ability to talk about it! Moreover, the symmetry of nature is considerably higher than that of a forget-me-not or of any other symmetry from [Table 34](#). A consequence of this high symmetry is, among others, the famous expression  $E_0 = mc^2$ .

---

\* ‘In the beginning, there was symmetry.’



**FIGURE 153** Forget-me-not, also called *Myosotis* (Boraginaceae) (© Markku Savela).

**TABLE 34** The classification and the number of simple geometric symmetries.

DIMENSION	REPETITION TYPES	TRANSLATIONS			
		0 POINT GROUPS	1 LINE GROUPS	2 PLANE GROUPS	3 SPACE GROUPS
1	1 row	2	2	n.a.	n.a.
2	5 nets	10 crystal groups	7 friezes	17 wall-papers	n.a.
3	14 lattices	32 crystal groups	75 rods	80 layers	230 crystal structures

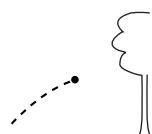
### WHY CAN WE THINK AND TALK ABOUT THE WORLD?

Ref. 185

“The hidden harmony is stronger than the apparent.”  
Heraclitus of Ephesus, about 500 BCE

Why can we understand somebody when he is talking about the world, even though we are not in his shoes? We can for two reasons: because most things look *similar* from different viewpoints, and because most of us have already had similar experiences *beforehand*.

‘Similar’ means that what *we* and what *others* observe somehow correspond. In other words, many aspects of observations do not depend on viewpoint. For example, the number of petals of a flower has the same value for all observers. We can therefore say that this quantity has the highest possible symmetry. We will see below that mass is another such example. Observables with the highest possible symmetry are called *scalars* in physics. Other aspects change from observer to observer. For example, the apparent size varies with the distance of observation. However, the actual size is observer-independent. In general terms, any type of *viewpoint-independence* is a form of symmetry, and the obser-



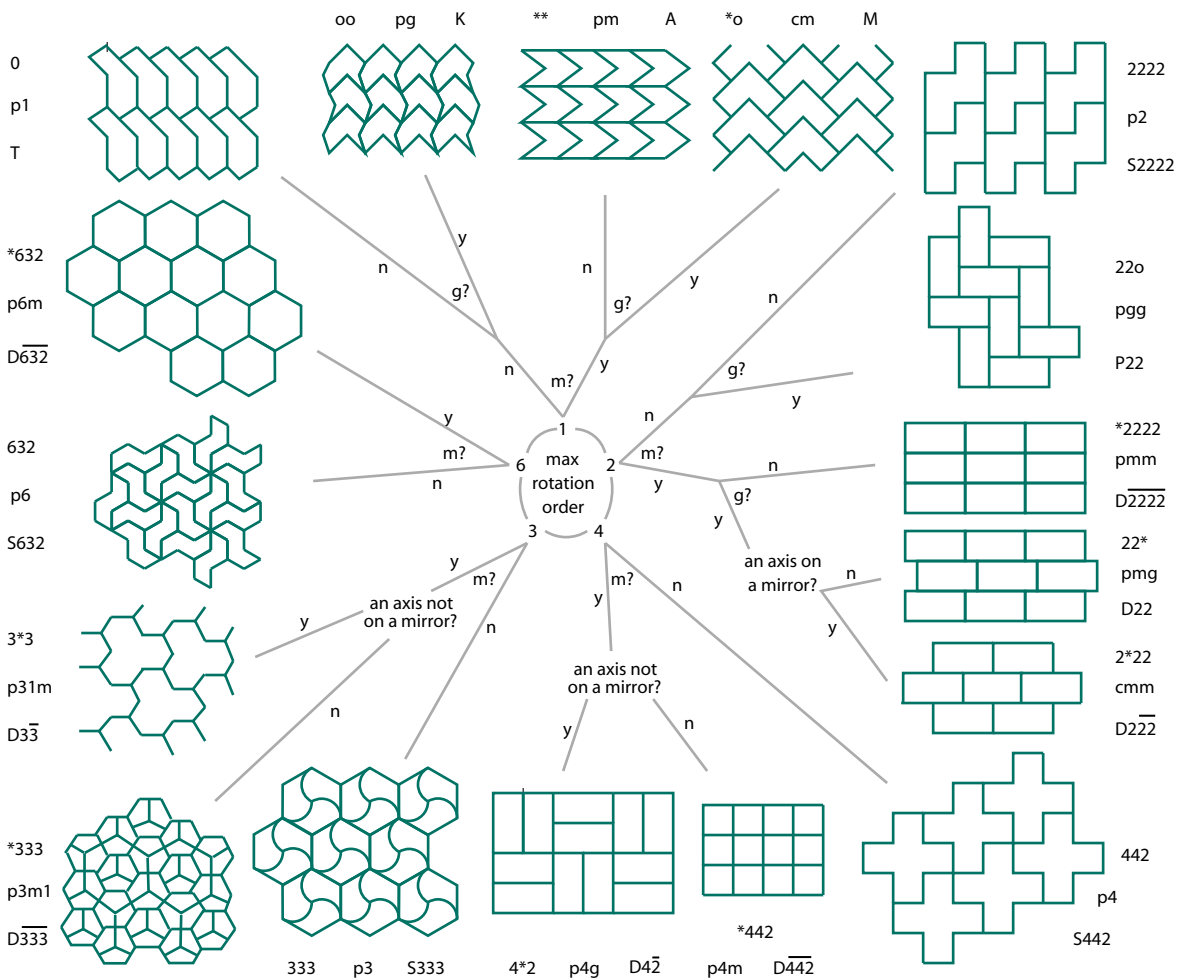


The 17 wallpaper patterns and a way to identify them quickly.

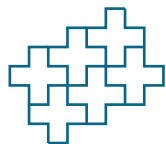
Is the maximum rotation order 1, 2, 3, 4 or 6?

Is there a mirror (m)? Is there an indecomposable glide reflection (g)?

Is there a rotation axis on a mirror? Is there a rotation axis not on a mirror?



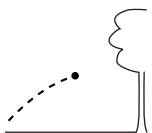
Every pattern is identified according to three systems of notation:



- 442 The Conway-Thurston notation.
- p4 The International Union of Crystallography notation.
- S442 The Montesinos notation, as in his book "Classical Tessellations and Three Manifolds"

FIGURE 154 The full list of possible symmetries of wallpaper patterns, the so-called *wallpaper groups*, their usual names, and a way to distinguish them (© Dror Bar-Natan).

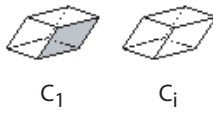
vation that two people looking at the same thing from different viewpoints can under-



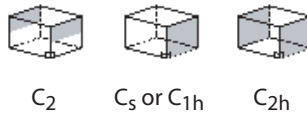
## Crystal system

## Crystall class or crystal group

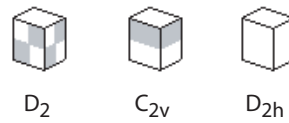
**Triclinic system**  
(three axes,  
none at right angles)



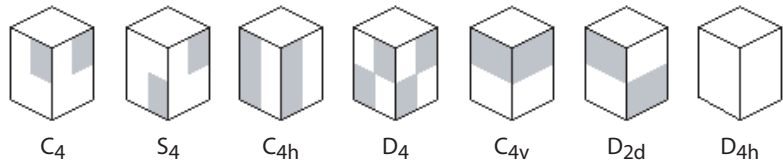
**Monoclinic system**  
(two axes at  
right angles, a  
third not)



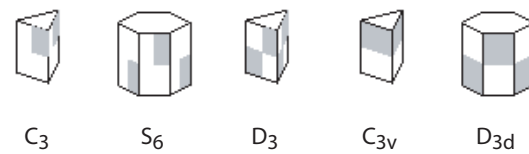
**Orthorhombic system**  
(three unequal axes  
at right angles)



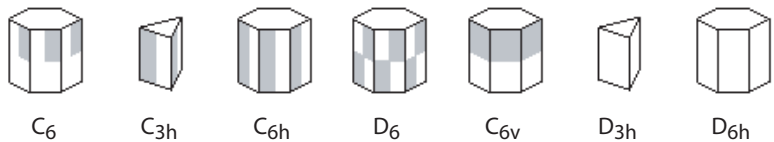
**Tetragonal system**  
(three axes at right  
angles, one  
unequal)



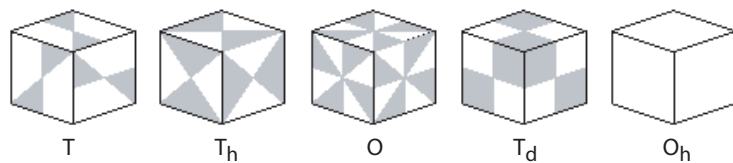
**Trigonal system**  
(three equal axes  
at 120 degrees, a  
fourth at right angles  
with threefold  
symmetry)



**Hexagonal system**  
(three equal axes  
at 120 degrees, a  
fourth at right  
angles with sixfold  
symmetry)

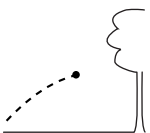


**Cubic or isometric  
system** (three equal  
axes at right  
angles)



**FIGURE 155** The full list of possible symmetries of units cells in crystals, the *crystallographic point groups* or *crystal groups* or *crystal classes* (© Jonathan Goss, after Neil Ashcroft and David Mermin).

stand each other proves that nature is symmetric. We start to explore the details of this



symmetry in this section and we will continue during most of the rest of our hike.

Challenge 419 s

In the world around us, we note another general property: not only does the same phenomenon look similar to different observers, but *different* phenomena look similar to the *same* observer. For example, we know that if fire burns the finger in the kitchen, it will do so outside the house as well, and also in other places and at other times. Nature shows *reproducibility*. Nature shows no surprises. In fact, our memory and our thinking are only possible because of this basic property of nature. (Can you confirm this?) As we will see, reproducibility leads to additional strong restrictions on the description of nature.

Without viewpoint-independence and reproducibility, talking to others or to oneself would be impossible. Even more importantly, we will discover that viewpoint-independence and reproducibility do more than determine the possibility of talking to each other: they also fix the *content* of what we can say to each other. In other words, we will see that our description of nature follows logically, almost without choice, from the simple fact that we can talk about nature to our friends.

### VIEWPOINTS

“Toleranz ... ist der Verdacht der andere könnte Recht haben.\*  
Kurt Tucholsky (1890–1935), German writer”

“Toleranz – eine Stärke, die man vor allem dem politischen Gegner wünscht.\*\*  
Wolfram Weidner (b. 1925) German journalist”

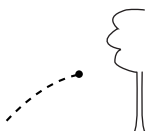
When a young human starts to meet other people in childhood, he quickly finds out that certain experiences are shared, while others, such as dreams, are not. Learning to make this distinction is one of the adventures of human life. In these pages, we concentrate on a section of the first type of experiences: *physical* observations. However, even among these, distinctions are to be made. In daily life we are used to assuming that weights, volumes, lengths and time intervals are independent of the viewpoint of the observer. We can talk about these observed quantities to anybody, and there are no disagreements over their values, provided they have been measured correctly. However, other quantities do depend on the observer. Imagine talking to a friend after he jumped from one of the trees along our path, while he is still falling downwards. He will say that the forest floor is approaching with high speed, whereas the observer below will maintain that the floor is stationary. Obviously, the difference between the statements is due to their different viewpoints. The velocity of an object (in this example that of the forest floor or of the friend himself) is thus a less symmetric property than weight or size. Not all observers agree on its value.

In the case of viewpoint-dependent observations, understanding is still possible with the help of a little effort: each observer can *imagine* observing from the point of view of the other, and *check* whether the imagined result agrees with the statement of the other.\*\*\* If the statement thus imagined and the actual statement of the other observer

\* ‘Tolerance ... is the suspicion that the other might be right.’

\*\* ‘Tolerance – a strength one mainly wishes to political opponents.’

\*\*\* Humans develop the ability to imagine that others can be in situations *different* from their own at the



agree, the observations are consistent, and the difference in statements is due only to the different viewpoints; otherwise, the difference is fundamental, and they cannot agree or talk. Using this approach, you can even argue whether human feelings, judgements, or tastes arise from fundamental differences or not.

Challenge 420 s

The distinction between viewpoint-independent (invariant) and viewpoint-dependent quantities is an essential one. Invariant quantities, such as mass or shape, describe *intrinsic* properties, and quantities depending on the observer make up the *state* of the system. Therefore, we must answer the following questions in order to find a *complete* description of the state of a physical system:

- Which viewpoints are possible?
- How are descriptions transformed from one viewpoint to another?
- Which observables do these symmetries admit?
- What do these results tell us about motion?

In the discussion so far, we have studied viewpoints differing in location, in orientation, in time and, most importantly, in motion. With respect to each other, observers can be at rest, move with constant speed, or accelerate. These ‘concrete’ changes of viewpoint are those we will study first. In this case the requirement of consistency of observations made by different observers is called the *principle of relativity*. The symmetries associated with this type of invariance are also called *external* symmetries. They are listed in [Table 36](#).

Page 130

Page 228

A second class of fundamental changes of viewpoint concerns ‘abstract’ changes. Viewpoints can differ by the mathematical description used: such changes are called *changes of gauge*. They will be introduced first in the section on electrodynamics. Again, it is required that all statements be consistent across different mathematical descriptions. This requirement of consistency is called the *principle of gauge invariance*. The associated symmetries are called *internal* symmetries.

Vol. III, page 71

The third class of changes, whose importance may not be evident from everyday life, is that of the behaviour of a system under exchange of its parts. The associated invariance is called *permutation symmetry*. It is a *discrete* symmetry, and we will encounter it when we explore quantum theory.

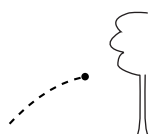
Vol. IV, page 93

The three consistency requirements described above are called ‘principles’ because these basic statements are so strong that they almost completely determine the ‘laws’ of physics, as we will see shortly. Later on we will discover that looking for a complete description of the state of objects will also yield a complete description of their *intrinsic* properties. But enough of introduction: let us come to the heart of the topic.

## SYMMETRIES AND GROUPS

Since we are looking for a description of motion that is complete, we need to understand and describe the full set of symmetries of nature. A system is said to be *symmetric* or to possess a *symmetry* if it appears identical when observed from different viewpoints. We also say that the system possesses an *invariance* under change from one viewpoint to the other. Viewpoint changes are called *symmetry operations* or *transformations*. A symmetry is thus a transformation, or more generally, a set of transformations. However, it is more

Ref. 186 age of about four years. Therefore, before the age of four, humans are unable to conceive special relativity; afterwards, they can.



than that: the successive application of two symmetry operations is another symmetry operation. To be more precise, a symmetry is a set  $G = \{a, b, c, \dots\}$  of elements, the transformations, together with a binary operation  $\circ$  called *concatenation* or *multiplication* and pronounced ‘after’ or ‘times’, in which the following properties hold for all elements  $a, b$  and  $c$ :

$$\begin{aligned} & \text{associativity, i.e., } (a \circ b) \circ c = a \circ (b \circ c) \\ & \text{a neutral element } e \text{ exists such that } e \circ a = a \circ e = a \\ & \text{an inverse element } a^{-1} \text{ exists such that } a^{-1} \circ a = a \circ a^{-1} = e \quad . \end{aligned} \quad (77)$$

Any set that fulfils these three defining properties, or axioms, is called a (*mathematical*) *group*. Historically, the notion of group was the first example of a mathematical structure which was defined in a completely abstract manner.\* Can you give an example of a group taken from daily life? Groups appear frequently in physics and mathematics, because symmetries are almost everywhere, as we will see.\*\* Can you list the symmetry operations of the pattern of Figure 156?

Challenge 421 s

Ref. 187

Challenge 422 s

### REPRESENTATIONS

Looking at a symmetric and composed system such as the one shown in Figure 156, we notice that each of its parts, for example each red patch, belongs to a set of similar objects, usually called a *multiplet*. Taken as a whole, the multiplet has (at least) the symmetry properties of the whole system. For some of the coloured patches in Figure 156 we need four objects to make up a full multiplet, whereas for others we need two, or only one, as in the case of the central star. In fact, in any symmetric system each part can be classified according to what type of multiplet it belongs to. Throughout our mountain ascent we will perform the same classification with every part of nature, with ever-increasing precision.

Challenge 423 e

A *multiplet* is a set of parts that transform into each other under all symmetry transformations. Mathematicians often call abstract multiplets *representations*. By specifying to which multiplet a component belongs, we describe in which way the component is part of the whole system. Let us see how this classification is achieved.

In mathematical language, symmetry transformations are often described by matrices. For example, in the plane, a reflection along the first diagonal is represented by the matrix

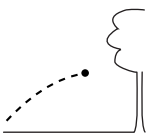
$$D(\text{refl}) = \begin{pmatrix} 0 & 1 \\ 1 & 0 \end{pmatrix}, \quad (78)$$

\* The term is due to Evariste Galois (1811–1832), the structure to Augustin-Louis Cauchy (1789–1857) and the axiomatic definition to Arthur Cayley (1821–1895).

\*\* In principle, mathematical groups need not be symmetry groups; but it can be proven that all groups can be seen as transformation groups on some suitably defined mathematical space, so that in mathematics we can use the terms ‘symmetry group’ and ‘group’ interchangeably.

A group is called *Abelian* if its concatenation operation is commutative, i.e., if  $a \circ b = b \circ a$  for all pairs of elements  $a$  and  $b$ . In this case the concatenation is sometimes called *addition*. Do rotations form an Abelian group?

A subset  $G_1 \subset G$  of a group  $G$  can itself be a group; one then calls it a *subgroup* and often says sloppily that  $G$  is *larger* than  $G_1$  or that  $G$  is a *higher* symmetry group than  $G_1$ .



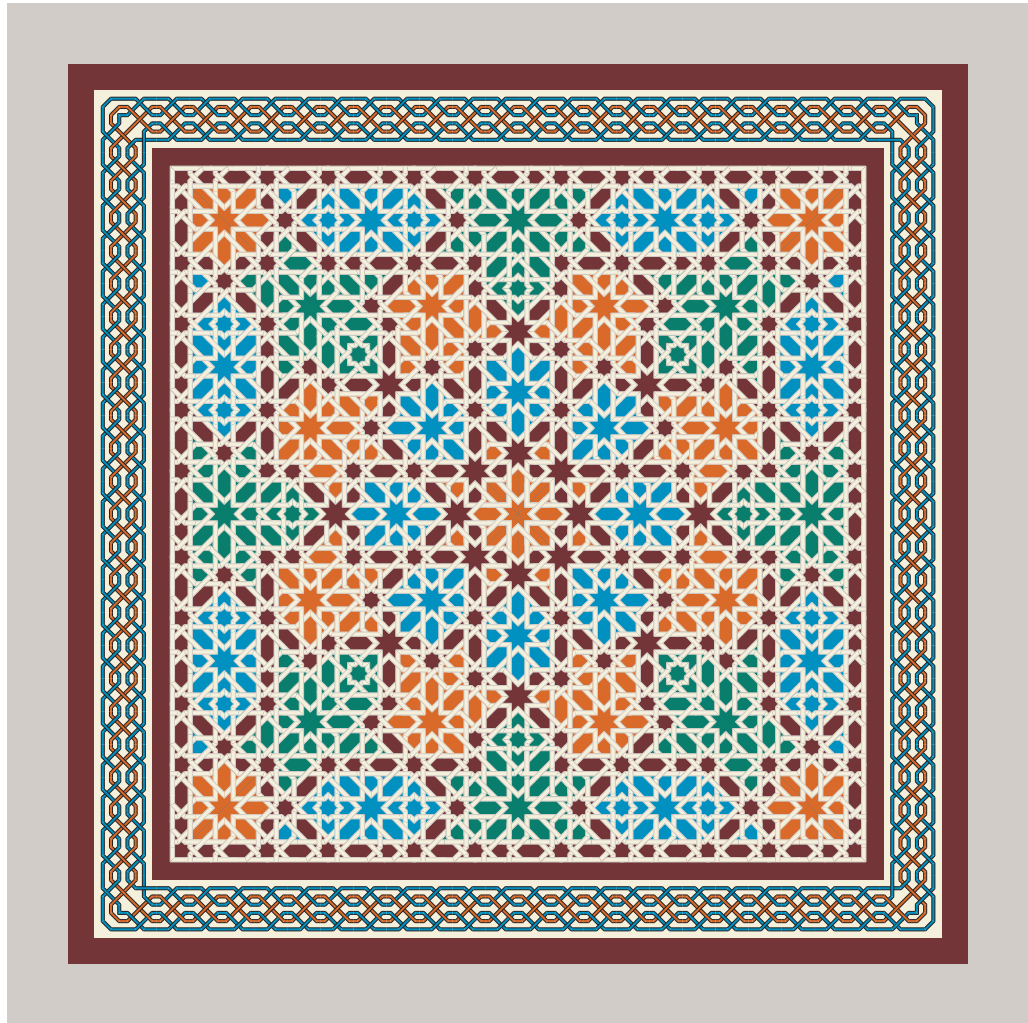


FIGURE 156 A Hispano-Arabic ornament from the Governor's Palace in Sevilla (© Christoph Schiller).

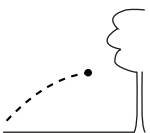
Challenge 424 e

since every point  $(x, y)$  becomes transformed to  $(y, x)$  when multiplied by the matrix  $D(\text{refl})$ . Therefore, for a mathematician a *representation* of a symmetry group  $G$  is an assignment of a matrix  $D(a)$  to each group element  $a$  such that the representation of the concatenation of two elements  $a$  and  $b$  is the product of the representations  $D$  of the elements:

$$D(a \circ b) = D(a)D(b) . \quad (79)$$

For example, the matrix of equation (78), together with the corresponding matrices for all the other symmetry operations, have this property.\*

\* There are some obvious, but important, side conditions for a representation: the matrices  $D(a)$  must be invertible, or non-singular, and the identity operation of  $G$  must be mapped to the unit matrix. In even more compact language one says that a representation is a *homomorphism* from  $G$  into the group of non-singular or invertible matrices. A matrix  $D$  is invertible if its determinant  $\det D$  is not zero.



For every symmetry group, the construction and classification of all possible representations is an important task. It corresponds to the classification of all possible multiplets a symmetric system can be made of. In this way, understanding the classification of all multiplets and parts which can appear in Figure 156 will teach us how to classify all possible parts of which an object or an example of motion can be composed!

A representation  $D$  is called *unitary* if all matrices  $D(a)$  are unitary.\* Almost all representations appearing in physics, with only a handful of exceptions, are unitary: this term is the most restrictive, since it specifies that the corresponding transformations are one-to-one and invertible, which means that one observer never sees more or less than another. Obviously, if an observer can talk to a second one, the second one can also talk to the first.

The final important property of a multiplet, or representation, concerns its structure. If a multiplet can be seen as composed of sub-multiplets, it is called *reducible*, else *irreducible*; the same is said about representations. The irreducible representations obviously cannot be decomposed any further. For example, the (almost perfect) symmetry group of Figure 156, commonly called  $D_4$ , has eight elements. It has the general, faithful, unitary and irreducible matrix representation

Challenge 425 e

$$\begin{pmatrix} \cos n\pi/2 & -\sin n\pi/2 \\ \sin n\pi/2 & \cos n\pi/2 \end{pmatrix} \quad n = 0..3, \begin{pmatrix} -1 & 0 \\ 0 & 1 \end{pmatrix}, \begin{pmatrix} 1 & 0 \\ 0 & -1 \end{pmatrix}, \begin{pmatrix} 0 & 1 \\ 1 & 0 \end{pmatrix}, \begin{pmatrix} 0 & -1 \\ -1 & 0 \end{pmatrix}. \quad (81)$$

Challenge 426 ny

The representation is an *octet*. The complete list of possible irreducible representations of the group  $D_4$  also includes *singlets*, *doublets* and *quartets*. Can you find them all? These representations allow the classification of all the white and black ribbons that appear in the figure, as well as all the coloured patches. The most symmetric elements are singlets, the least symmetric ones are members of the quartets. The complete system is always a singlet as well.

With these concepts we are ready to talk about motion with improved precision.

---

In general, if a mapping  $f$  from a group  $G$  to another  $G'$  satisfies

$$f(a \circ_G b) = f(a) \circ_{G'} f(b), \quad (80)$$

the mapping  $f$  is called an *homomorphism*. A homomorphism  $f$  that is one-to-one (injective) and onto (surjective) is called a *isomorphism*. If a representation is also injective, it is called *faithful*, *true* or *proper*.

In the same way as groups, more complex mathematical structures such as rings, fields and associative algebras may also be represented by suitable classes of matrices. A representation of the field of complex numbers is given later on.

Vol. IV, page 189

\* The *transpose*  $A^T$  of a matrix  $A$  is defined element-by-element by  $(A^T)_{ik} = A_{ki}$ . The *complex conjugate*  $A^*$  of a matrix  $A$  is defined by  $(A^*)_{ik} = (A_{ik})^*$ . The *adjoint*  $A^\dagger$  of a matrix  $A$  is defined by  $A^\dagger = (A^T)^*$ . A matrix is called *symmetric* if  $A^T = A$ , *orthogonal* if  $A^T = A^{-1}$ , *Hermitean* or *self-adjoint* (the two are synonymous in all physical applications) if  $A^\dagger = A$  (Hermitean matrices have real eigenvalues), and *unitary* if  $A^\dagger = A^{-1}$ . Unitary matrices have eigenvalues of norm one. Multiplication by a unitary matrix is a one-to-one mapping; since the time evolution of physical systems is a mapping from one time to another, evolution is always described by a unitary matrix.

An *antisymmetric* or *skew-symmetric* matrix is defined by  $A^T = -A$ , an *anti-Hermitean* matrix by  $A^\dagger = -A$  and an *anti-unitary* matrix by  $A^\dagger = -A^{-1}$ . All the corresponding mappings are one-to-one.

A matrix is *singular*, and the corresponding vector transformation is not one-to-one, if  $\det A = 0$ .

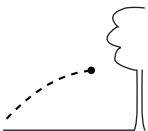




TABLE 35 Correspondences between the symmetries of an ornament, a flower and nature as a whole.

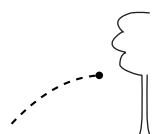
SYSTEM	HISPANO-ARABIC PATTERN	FLOWER	MOTION
Structure and components	set of ribbons and patches	set of petals, stem	motion path and observables
System symmetry	pattern symmetry	flower symmetry	symmetry of Lagrangian
Mathematical description of the symmetry group	$D_4$	$C_5$	in Galilean relativity: position, orientation, instant and velocity changes
Invariants	number of multiplet elements	petal number	number of coordinates, magnitude of scalars, vectors and tensors
Representations of the components	multiplet types of elements	multiplet types of components	tensors, including scalars and vectors
Most symmetric representation	singlet	part with circular symmetry	scalar
Simplest faithful representation	quartet	quintet	vector
Least symmetric representation	quartet	quintet	no limit (tensor of infinite rank)

### SYMMETRIES, MOTION AND GALILEAN PHYSICS

Every day we experience that we are able to talk to each other about motion. It must therefore be possible to find an *invariant* quantity describing it. We already know it: it is the *action*, the measure of change. For example, lighting a match is a change. The magnitude of the change is the same whether the match is lit here or there, in one direction or another, today or tomorrow. Indeed, the (Galilean) action is a number whose value is the same for each observer *at rest*, independent of his orientation or the time at which he makes his observation.

In the case of the Arabic pattern of Figure 156, the symmetry allows us to deduce the list of multiplets, or representations, that can be its building blocks. This approach must be possible for motion as well. In the case of the Arabic pattern, from the various possible observation viewpoints, we deduced the classification of the ribbons into singlets, doublets, etc. For a moving system, the building blocks, corresponding to the ribbons, are the *observables*. Since we observe that nature is symmetric under many different changes of viewpoint, we can classify all observables. To do so, we first need to take the list of all viewpoint transformations and then deduce the list of all their representations.

Our everyday life shows that the world stays unchanged after changes in position,



orientation and instant of observation. One also speaks of space translation invariance, rotation invariance and time translation invariance. These transformations are different from those of the Arabic pattern in two respects: they are *continuous* and they are *unbounded*. As a result, their representations will generally be continuously variable and without bounds: they will be *quantities* or *magnitudes*. In other words, observables will be constructed with *numbers*. In this way we have deduced why numbers are *necessary* for any description of motion.\*

Since observers can differ in orientation, most representations will be objects possessing a direction. To cut a long story short, the symmetry under change of observation position, orientation or instant leads to the result that all observables are either ‘scalars’, ‘vectors’ or higher-order ‘tensors.’\*\*

A *scalar* is an observable quantity which stays the same for all observers: it corresponds to a singlet. Examples are the mass or the charge of an object, the distance between two points, the distance of the horizon, and many others. Their possible values are (usually) continuous, unbounded and without direction. Other examples of scalars are the potential at a point and the temperature at a point. Velocity is obviously not a scalar; nor is the coordinate of a point. Can you find more examples and counter-examples?

Challenge 428 s

Energy is a puzzling observable. It is a scalar if only changes of place, orientation and instant of observation are considered. But energy is not a scalar if changes of observer speed are included. Nobody ever searched for a generalization of energy that is a scalar also for moving observers. Only Albert Einstein discovered it, completely by accident. More about this issue shortly.

Any quantity which has a magnitude and a direction and which ‘stays the same’ with respect to the environment when changing viewpoint is a *vector*. For example, the arrow between two fixed points on the floor is a vector. Its length is the same for all observers; its direction changes from observer to observer, but not with respect to its environment. On the other hand, the arrow between a tree and the place where a rainbow touches the Earth is *not* a vector, since that place does not stay fixed with respect to the environment, when the observer changes.

Mathematicians say that vectors are directed entities staying invariant under coordinate transformations. Velocities of objects, accelerations and field strength are examples of vectors. (Can you confirm this?) The magnitude of a vector is a scalar: it is the same for any observer. By the way, a famous and baffling result of nineteenth-century experiments is that the velocity of a light beam is *not* a vector like the velocity of a car; the velocity of a light beam is not a vector for Galilean transformations. This mystery will be solved shortly.

Challenge 429 e

Tensors are generalized vectors. As an example, take the moment of inertia of an object. It specifies the dependence of the angular momentum on the angular velocity. For any object, doubling the magnitude of angular velocity doubles the magnitude of angular momentum; however, the two vectors are not parallel to each other if the object is not a sphere. In general, if any two vector quantities are proportional, in the sense that doubling the magnitude of one vector doubles the magnitude of the other, but without

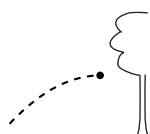
Page 102

Page 135

Challenge 427 e

\* Only scalars, in contrast to vectors and higher-order tensors, may also be quantities which only take a discrete set of values, such as +1 or -1 only. In short, only scalars may be *discrete* observables.

\*\* Later on, *spinors* will be added to, and complete, this list.



the two vectors being parallel to each other, then the proportionality ‘factor’ is a (second order) *tensor*. Like all proportionality factors, tensors have a magnitude. In addition, tensors have a direction and a *shape*: they describe the connection between the vectors they relate. Just as vectors are the simplest quantities with a magnitude and a direction, so tensors are the simplest quantities with a magnitude and with a direction depending on a second, chosen direction. Vectors can be visualized as oriented arrows; tensors can be visualized as oriented ellipsoids.\* Can you name another example of tensor?

Challenge 431 s

Let us get back to the description of motion. Table 35 shows that in physical systems we always have to distinguish between the symmetry of the whole Lagrangian – corresponding to the symmetry of the complete pattern – and the representation of the observables – corresponding to the ribbon multiplets. Since the action must be a scalar, and since all observables must be tensors, Lagrangians contain sums and products of tensors only in combinations forming scalars. Lagrangians thus contain only scalar products or generalizations thereof. In short, Lagrangians always look like

$$L = \alpha a_i b^i + \beta c_{jk} d^{jk} + \gamma e_{lmn} f^{lmn} + \dots \quad (82)$$

where the indices attached to the variables  $a$ ,  $b$ ,  $c$  etc. always come in matching pairs to be summed over. (Therefore summation signs are usually simply left out.) The Greek letters represent constants. For example, the action of a free point particle in Galilean physics was given as

$$S = \int L dt = \frac{m}{2} \int v^2 dt \quad (83)$$

which is indeed of the form just mentioned. We will encounter many other cases during our study of motion.\*\*

Page 130

Galileo already understood that motion is also invariant under change of viewpoints with different velocity. However, the action just given does not reflect this. It took some

\* A rank- $n$  tensor is the proportionality factor between a rank-1 tensor, i.e., between a vector, and an rank- $(n-1)$  tensor. Vectors and scalars are rank 1 and rank 0 tensors. Scalars can be pictured as spheres, vectors as arrows, and rank-2 tensors as ellipsoids. Tensors of higher rank correspond to more and more complex shapes.

A vector has the same length and direction for every observer; a tensor (of rank 2) has the same determinant, the same trace, and the same sum of diagonal subdeterminants for all observers.

A vector is described mathematically by a *list* of components; a tensor (of rank 2) is described by a *matrix* of components. The rank or order of a tensor thus gives the number of indices the observable has. Can you show this?

Challenge 430 e

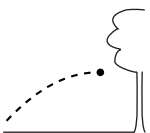
\*\* By the way, is the usual list of possible observation viewpoints – namely different positions, different observation instants, different orientations, and different velocities – also *complete* for the action (83)? Surprisingly, the answer is no. One of the first who noted this fact was Niederer, in 1972. Studying the quantum theory of point particles, he found that even the action of a Galilean free point particle is invariant under some additional transformations. If the two observers use the coordinates  $(t, \mathbf{x})$  and  $(\tau, \boldsymbol{\xi})$ , the action (83) is invariant under the transformations

Ref. 188

Challenge 432 ny

$$\boldsymbol{\xi} = \frac{\mathbf{r}\mathbf{x} + \mathbf{x}_0 + \mathbf{v}t}{\gamma t + \delta} \quad \text{and} \quad \tau = \frac{\alpha t + \beta}{\gamma t + \delta} \quad \text{with} \quad \mathbf{r}^T \mathbf{r} = \mathbf{1} \quad \text{and} \quad \alpha\delta - \beta\gamma = 1. \quad (84)$$

where  $\mathbf{r}$  describes the rotation from the orientation of one observer to the other,  $\mathbf{v}$  the velocity between the two observers, and  $\mathbf{x}_0$  the vector between the two origins at time zero. This group contains two important



years to find out the correct generalization: it is given by the theory of special relativity. But before we study it, we need to finish the present topic.

REPRODUCIBILITY, CONSERVATION AND NOETHER’S THEOREM

“ I will leave my mass, charge and momentum to science. ”  
 Graffito

Challenge 433 ny

The reproducibility of observations, i.e., the symmetry under change of instant of time or ‘time translation invariance’, is a case of viewpoint-independence. (That is not obvious; can you find its irreducible representations?) The connection has several important consequences. We have seen that symmetry implies invariance. It turns out that for *continuous* symmetries, such as time translation symmetry, this statement can be made more precise: for any continuous symmetry of the Lagrangian there is an associated conserved constant of motion and vice versa. The exact formulation of this connection is the theorem of Emmy Noether.\* She found the result in 1915 when helping Albert Einstein and David Hilbert, who were both struggling and competing at constructing general relativity. However, the result applies to any type of Lagrangian.

Ref. 189

Noether investigated continuous symmetries depending on a continuous parameter  $b$ . A viewpoint transformation is a symmetry if the action  $S$  does not depend on the value of  $b$ . For example, changing position as

$$x \mapsto x + b \tag{86}$$

leaves the action

$$S_0 = \int T(v) - U(x) dt \tag{87}$$

invariant, since  $S(b) = S_0$ . This situation implies that

$$\frac{\partial T}{\partial v} = p = \text{const} \quad ; \tag{88}$$

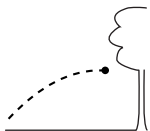
in short, symmetry under change of position implies conservation of momentum. The

special cases of transformations:

$$\begin{aligned} &\text{The connected, static Galilei group } \xi = \mathbf{rx} + \mathbf{x}_0 + \mathbf{vt} \quad \text{and} \quad \tau = t \\ &\text{The transformation group } \text{SL}(2,\mathbb{R}) \quad \xi = \frac{\mathbf{x}}{\gamma t + \delta} \quad \text{and} \quad \tau = \frac{\alpha t + \beta}{\gamma t + \delta} \end{aligned} \tag{85}$$

The latter, three-parameter group includes *spatial inversion*, *dilations*, *time translation* and a set of time-dependent transformations such as  $\xi = \mathbf{x}/t$ ,  $\tau = 1/t$  called *expansions*. Dilations and expansions are rarely mentioned, as they are symmetries of point particles only, and do not apply to everyday objects and systems. They will return to be of importance later on, however.

\* Emmy Noether (b. 1882 Erlangen, d. 1935 Bryn Mayr), German mathematician. The theorem is only a sideline in her career which she dedicated mostly to number theory. The theorem also applies to gauge symmetries, where it states that to every gauge symmetry corresponds an identity of the equation of motion, and vice versa.



converse is also true.

Challenge 434 ny

In the case of symmetry under shift of observation instant, we find

$$T + U = \text{const} \quad ; \quad (89)$$

in other words, time translation invariance implies constant energy. Again, the converse is also correct. One also says that energy and momentum are the *generators* of time and space translations.

The conserved quantity for a continuous symmetry is sometimes called the *Noether charge*, because the term *charge* is used in theoretical physics to designate conserved extensive observables. So, energy and momentum are Noether charges. ‘Electric charge’, ‘gravitational charge’ (i.e., mass) and ‘topological charge’ are other common examples.

Challenge 435 s

What is the conserved charge for rotation invariance?

We note that the expression ‘energy is conserved’ has several meanings. First of all, it means that the energy of a *single* free particle is constant in time. Secondly, it means that the total energy of any number of independent particles is constant. Finally, it means that the energy of a *system* of particles, i.e., including their interactions, is constant in time. Collisions are examples of the latter case. Noether’s theorem makes all of these points at the same time, as you can verify using the corresponding Lagrangians.

Challenge 436 e

But Noether’s theorem also makes, or rather repeats, an even stronger statement: if energy were not conserved, time could not be defined. The whole description of nature requires the existence of conserved quantities, as we noticed when we introduced the concepts of object, state and environment. For example, we defined objects as *permanent* entities, that is, as entities characterized by conserved quantities. We also saw that the introduction of time is possible only because in nature there are ‘no surprises’. Noether’s theorem describes exactly what such a ‘surprise’ would have to be: the non-conservation of energy. However, energy jumps have never been observed – not even at the quantum level.

Page 25

Page 191

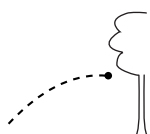
Since symmetries are so important for the description of nature, [Table 36](#) gives an overview of all the symmetries of nature we will encounter. Their main properties are also listed. Except for those marked as ‘approximate’ or ‘speculative’, an experimental proof of incorrectness of any of them would be a big surprise indeed.

**TABLE 36** The symmetries of relativity and quantum theory with their properties; also the complete list of logical *inductions* used in the two fields.

SYMMETRY	TYPE [ NUMBER OF PARAMETERS ]	SPACE OF ACTION	GROUP TOPOLOGY	POSSIBLE REPRESENTATIONS	CONSERVED QUANTITIES	VACUUM / MATTER IS METRIC	MAIN EFFECT
----------	----------------------------------	-----------------	----------------	--------------------------	----------------------	---------------------------	-------------

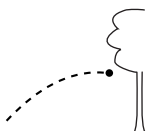
**Geometric or space-time, external, symmetries**

Time and space translation	$R \times R^3$ [4 par.]	space, time	not compact	scalars, vectors,	momentum and energy	yes/yes	allow everyday
----------------------------	----------------------------	-------------	-------------	-------------------	---------------------	---------	----------------

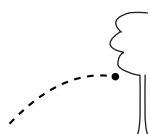


SYMMETRY	TYPE [NUMBER OF PARAMETERS]	SPACE OF ACTION	GROUP TOPOLOGY	POSSIBLE REPRESENTATIONS	CONSERVED QUANTITIES	VACUUM/ MATTER IS SYMMETRIC	MAIN EFFECT
Rotation	SO(3) [3 par.]	space	$S^2$	tensors	angular momentum	yes/yes	communication
Galilei boost	$R^3$ [3 par.]	space, time	not compact	scalars, vectors, tensors	velocity of centre of mass	yes/for low speeds	relativity of motion
Lorentz	homogeneous Lie SO(3,1) [6 par.]	space-time	not compact	tensors, spinors	energy-momentum $T^{\mu\nu}$	yes/yes	constant light speed
Poincaré ISL(2,C)	inhomogeneous Lie [10 par.]	space-time	not compact	tensors, spinors	energy-momentum $T^{\mu\nu}$	yes/yes	
Dilation invariance	$R^+$ [1 par.]	space-time	ray	$n$ -dimen. continuum	none	yes/no	massless particles
Special conformal invariance	$R^4$ [4 par.]	space-time	$R^4$	$n$ -dimen. continuum	none	yes/no	massless particles
Conformal invariance	[15 par.]	space-time	involved	massless tensors, spinors	none	yes/no	light cone invariance
<b>Dynamic, interaction-dependent symmetries: gravity</b>							
$1/r^2$ gravity	SO(4) [6 par.]	config. space	as SO(4)	vector pair	perihelion direction	yes/yes	closed orbits
Diffeomorphism invariance	$[\infty$ par.]	space-time	involved	space-times	local energy-momentum	yes/no	perihelion shift
<b>Dynamic, classical and quantum-mechanical motion symmetries</b>							
Motion('time') inversion T	discrete	Hilbert or phase space	discrete	even, odd	T-parity	yes/no	reversibility
Parity('spatial') inversion P	discrete	Hilbert or phase space	discrete	even, odd	P-parity	yes/no	mirror world exists

Motion Mountain – The Adventure of Physics pdf file available free of charge at www.motionmountain.net Copyright © Christoph Schiller November 1997–June 2011



SYMMETRY	TYPE [NUMBER OF PARAM- ETERS]	SPACE OF AC- TION	GROUP TOPOLOGY	POSSI- BLE REPRE- SENTA- TIONS	CON- SERVED QUAN- TITY	VAC- UUM/ MAT- TER IS SYM- METRIC	MAIN EFFECT
Charge conjugation C	global, antilinear, anti-Hermitian	Hilbert space	discrete or phase space	even, odd	C-parity	yes/no	antiparticles exist
CPT	discrete	Hilbert space	discrete or phase space	even	CPT-parity	yes/yes	makes field theory possible
<b>Dynamic, interaction-dependent, gauge symmetries</b>							
Electromagnetic classical gauge invariance	[ $\infty$ par.]	space of fields	unimportant	unimportant	electric charge	yes/yes	massless light
Electromagnetic q.m. gauge inv.	Abelian Lie U(1) [1 par.]	Hilbert space	circle $S^1$	fields	electric charge	yes/yes	massless photon
Electromagnetic duality	Abelian Lie U(1) [1 par.]	space of fields	circle $S^1$	abstract	abstract	yes/no	none
Weak gauge	non-Abelian Lie SU(2) [3 par.]	Hilbert space	as SU(3)	particles	weak charge	no/approx.	
Colour gauge	non-Abelian Lie SU(3) [8 par.]	Hilbert space	as SU(3)	coloured quarks	colour	yes/yes	massless gluons
Chiral symmetry	discrete	fermions	discrete	left, right	helicity	approximately	'massless' fermions <sup>a</sup>
<b>Permutation symmetries</b>							
Particle exchange	discrete	Fock space etc.	discrete	fermions and bosons	none	n.a./yes	Gibbs' paradox
<b>Selected <i>speculative</i> symmetries of nature</b>							
GUT	$E_8$ , SO(10)	Hilbert space	from Lie group	particles	from Lie group	yes/no	coupling constant convergence





SYMMETRY	TYPE [NUMBER OF PARAMETERS]	SPACE OF ACTION	GROUP TOPOLOGY	POSSIBLE REPRESENTATIONS	CONSERVED QUANTITIES	VACUUM/ MATTER IS SYMMETRIC	MAIN EFFECT
N-supersymmetry <sup>b</sup>	global	Hilbert		particles, sparticles	$T_{mn}$ and $N$ spinors <sup>c</sup> $Q_{imn}$	no/no	'massless' <sup>a</sup> particles
R-parity	discrete	Hilbert	discrete	+1, -1	R-parity	yes/yes	sfermions, gauginos
Braid symmetry	discrete	own space	discrete	unclear	unclear	yes/maybe	unclear
Space-time duality	discrete	all	discrete	vacuum	unclear	yes/maybe	fixes particle masses
Event symmetry	discrete	space-time	discrete	nature	none	yes/no	unclear

For details about the connection between symmetry and induction, see [page 226](#). The explanation of the terms in the table will be completed in the rest of the walk. The real numbers are denoted as  $R$ .

a. Only approximate; 'massless' means that  $m \ll m_{pl}$ , i.e., that  $m \ll 22 \mu\text{g}$ .

b.  $N = 1$  supersymmetry, but not  $N = 1$  supergravity, is sometimes claimed to be an approximation at everyday energies.

c.  $i = 1 \dots N$ .

**CURIOSITIES AND FUN CHALLENGES ABOUT SYMMETRY**

Challenge 437 ny What is the path followed by four turtles starting on the four angles of a square, if each of them continuously walks at the same speed towards the next one?

\* \*

Challenge 438 s What is the symmetry of a simple oscillation? And of a wave?

\* \*

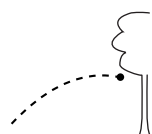
Challenge 439 s For what systems is motion reversal a symmetry transformation?

\* \*

Challenge 440 ny What is the symmetry of a continuous rotation?

\* \*

A sphere has a tensor for the moment of inertia that is diagonal with three equal numbers.



Challenge 441 ny The same is true for a cube. Can you distinguish spheres and cubes by their rotation behaviour?

\* \*

Challenge 442 ny Is there a motion in nature whose symmetry is perfect?

\* \*

Can you show that in two dimensions, *finite* objects can have only rotation and reflection symmetry, in contrast to *infinite* objects, which can have also translation and glide-reflection symmetry? Can you prove that for finite objects in two dimensions, if no rotation symmetry is present, there is only one reflection symmetry? And that all possible rotations are always about the same centre? Can you deduce from this that at least one point is unchanged in all symmetrical finite two-dimensional objects?

Challenge 443 e

\* \*

Can you show that in three dimensions, *finite* objects can have only rotation, reflection, inversion and rotatory inversion symmetry, in contrast to *infinite* objects, which can have also translation, glide-reflection, and screw rotation symmetry? Can you prove that for finite objects in three dimensions, if no rotation symmetry is present, there is only one reflection plane? And that for all inversions or rotatory inversions the centre must lie on a rotation axis or on a reflection plane? Can you deduce from this that at least one point is unchanged in all symmetrical finite three-dimensional objects?

Challenge 444 e

### PARITY AND TIME INVARIANCE

The table of symmetries also list two so-called *discrete* symmetries that are important for the discussion of motion.

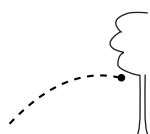
How far can you throw a stone with your other hand? Most people have a preferred hand, and the differences are quite pronounced. Does nature have such a preference? In everyday life, the answer is clear: everything that happens can also happen the other way round. This has also been tested in precision experiments; it was found that everything happening through gravitation, electricity and magnetism can also happen in a mirrored way. There are no exceptions. For example, there are people with the heart on the right side; there are snails with left-handed houses; there are planets that rotate the other way. Astronomy and everyday life are *mirror-invariant*. One also says that gravitation and electromagnetism are *parity invariant*. (Later we will discover an exception to this statement.)

Vol. V, page 177

Can things happen backwards? This question is not easy. A study of motion due to gravitation shows that such motion can always also happen in the reverse direction. In case of motion due to electricity and magnetism, such as the behaviour of atoms in gases and liquids, the question is more involved; we will discuss it in the section of thermodynamics.

### SUMMARY ON SYMMETRY

Symmetry is partial invariance to change. The simplest symmetries are geometrical: the point symmetries of flowers or translation symmetry of infinite crystals are examples.



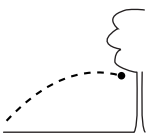
All possible changes that leave a system invariant – i.e., all possible symmetry transformations of a system – form a mathematical group. Apart from geometrical symmetry groups, several additional symmetry groups appear in nature.

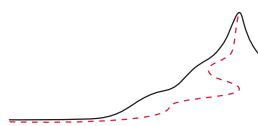
The reproducibility and predictability of nature implies several fundamental continuous symmetries: since we can *talk* about nature we can deduce that above all, nature is symmetrical under time and space translations. Motion is universal. Any universality statement implies a symmetry. As further examples, everyday observations are found to be mirror symmetric, and simple motions are found to be symmetric under motion reversal. These are fundamental discrete symmetries.

From nature's continuous symmetries, using Noether's theorem, we can deduce conserved 'charges'. These are energy, linear momentum and angular momentum. In other words, the definition of mass, space and time, together with their symmetry properties, is *equivalent* to the conservation of energy and momenta. Conservation and symmetry are two ways to express the same property of nature. To put it simply, our ability to talk about nature means that energy, linear momentum and angular momentum are conserved.

The isolability of systems from their surroundings implies a symmetry of interactions: since the behaviour of isolated systems is independent from what happens in their surroundings, interactions must have no effect at large distances.

An elegant way to uncover the 'laws' of nature is to search for nature's symmetries. In many historical cases, once this connection had been understood, physics made rapid progress. For example, Albert Einstein discovered the theory of relativity in this way, and Paul Dirac started off quantum electrodynamics. We will use the same method throughout our walk; in our final leg we will uncover some symmetries which are even more mind-boggling than those of relativity. Now, though, we will move on to the next approach to a global description of motion.





# SIMPLE MOTIONS OF EXTENDED BODIES – OSCILLATIONS AND WAVES

We defined action, and thus change, as the integral of the Lagrangian, and the Lagrangian as the difference between kinetic and potential energy. One of the simplest systems in nature is a mass  $m$  attached to a (linear) spring. The Lagrangian for its position  $x$  is given by

$$L = \frac{1}{2}mv^2 - \frac{1}{2}kx^2, \quad (90)$$

where  $k$  is a quantity characterizing the spring, the so-called spring constant. The Lagrangian is due to Robert Hooke, in the seventeenth century. Can you confirm it?

Challenge 445 e

The motion that results from this Lagrangian is periodic, and shown in [Figure 157](#). The Lagrangian (90) thus describes the oscillation of the spring length. The motion is exactly the same as that of a long pendulum. It is called *harmonic motion*, because an object vibrating rapidly in this way produces a completely pure – or harmonic – musical sound. (The musical instrument producing the purest harmonic waves is the transverse flute. This instrument thus gives the best idea of how harmonic motion ‘sounds’.)

The graph of this harmonic or linear oscillation, shown in [Figure 157](#), is called a *sine curve*; it can be seen as the basic building block of all oscillations. All other, non-harmonic oscillations in nature can be composed from sine curves, as we shall see shortly.

Page 237

Any quantity  $x(t)$  that oscillates harmonically is described by its amplitude  $A$ , its angular frequency  $\omega$  and its phase  $\varphi$ :

$$x(t) = A \sin(\omega t + \varphi). \quad (91)$$

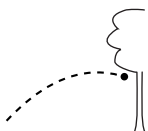
The amplitude and the phase depend on the way the oscillation is started. In contrast, the angular frequency is an intrinsic property of the system. Can you show that for the mass attached to the spring, we have  $\omega = 2\pi f = 2\pi/T = \sqrt{k/m}$ ?

Challenge 446 e

Every oscillating motion continuously transforms kinetic energy into potential energy and vice versa. This is the case for the tides, the pendulum, or any radio receiver. But many oscillations also diminish in time: they are damped. Systems with large damping, such as the shock absorbers in cars, are used to avoid oscillations. Systems with *small* damping are useful for making precise and long-running clocks. The simplest measure of damping is the number of oscillations a system takes to reduce its amplitude to  $1/e \approx 1/2.718$  times the original value. This characteristic number is the so-called *Q-factor*, named after the abbreviation of ‘quality factor’. A poor Q-factor is 1 or less, an extremely good one is 100 000 or more. (Can you write down a simple Lagrangian for a damped

TABLE 37 Some mechanical frequency values found in nature.

OBSERVATION	FREQUENCY
Sound frequencies in gas emitted by black holes	c. 1 fHz
Precision in measured vibration frequencies of the Sun	down to 2 nHz
Vibration frequencies of the Sun	down to c. 300 nHz
Vibration frequencies that disturb gravitational radiation detection	down to 3 $\mu$ Hz
Lowest vibration frequency of the Earth <a href="#">Ref. 192</a>	309 $\mu$ Hz
Resonance frequency of stomach and internal organs (giving the 'sound in the belly' experience)	1 to 10 Hz
Common music tempo	2 Hz
Adult male speaking voice, fundamental	85 to 180 Hz
Adult female speaking voice, fundamental	165 to 255 Hz
Official value, or <i>standard pitch</i> , of musical note 'A' or 'la', following ISO 16 (and of the telephone line signal in many countries)	440 Hz
Common values of musical note 'A' or 'la' used by orchestras	442 to 451 Hz
Wing beat of tiny fly	c. 1000 Hz
Sound audible to young humans	20 Hz to 20 kHz
Sonar used by bats	up to over 100 kHz
Sonar used by dolphins	up to 150 kHz
Sound frequency used in ultrasound imaging	2 to 20 MHz
Quartz oscillator frequencies	20 kHz up to 350 MHz
Radio emission of atomic hydrogen, esp. in the universe	1420.405 751 8(1) MHz
Highest electronically generated frequency (with CMOS, in 2007)	324 GHz
Phonon (sound) frequencies measured in single crystals	up to 20 THz and more



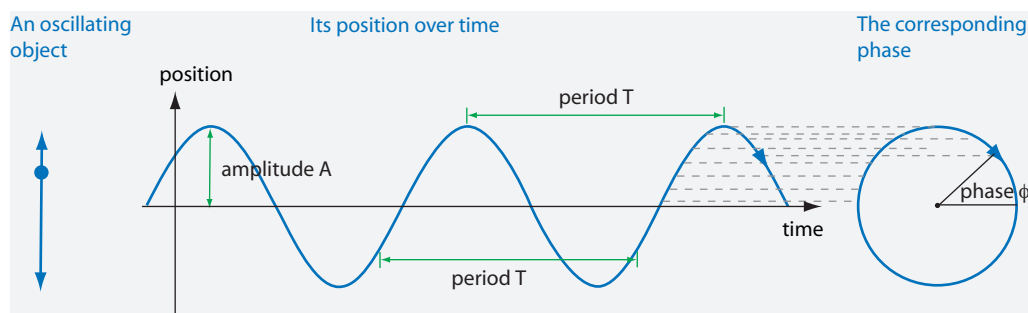


FIGURE 157 The simplest oscillation, the *linear* or *harmonic* oscillation: how position changes over time, and how it is related to rotation.

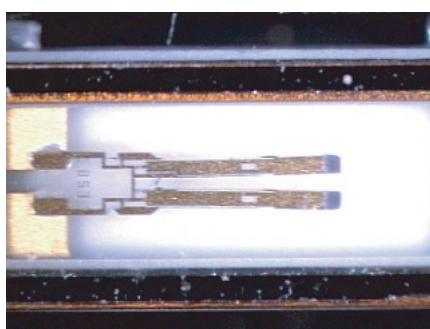


FIGURE 158 The interior of a commercial quartz oscillator, driven at high amplitude (QuickTime film © Microcrystal)

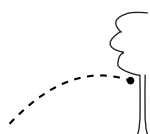
Challenge 447 ny

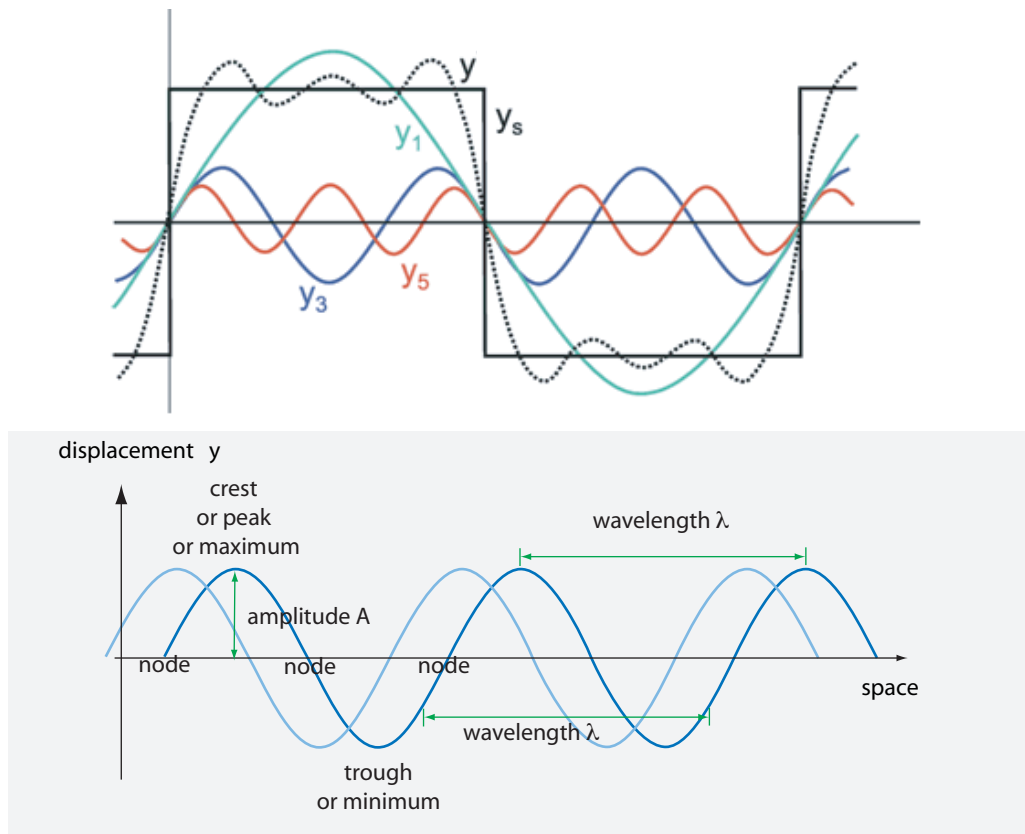
oscillation with a given  $Q$ -factor?) In nature, damped oscillations do not usually keep constant frequency; however, for the simple pendulum this remains the case to a high degree of accuracy. The reason is that for a pendulum, the frequency does not depend significantly on the amplitude (as long as the amplitude is smaller than about  $20^\circ$ ). This is one reason why pendulums are used as oscillators in mechanical clocks.

Obviously, for a good clock, the driving oscillation must not only show small damping, but must also be independent of temperature and be insensitive to other external influences. An important development of the twentieth century was the introduction of quartz crystals as oscillators. Technical quartzes are crystals of the size of a few grains of sand; they can be made to oscillate by applying an electric signal. They have little temperature dependence and a large  $Q$ -factor, and therefore low energy consumption, so that precise clocks can now run on small batteries.

Every harmonic oscillation is described by three quantities: the *amplitude*, the *period* (the inverse of the frequency) and the *phase*. The phase distinguishes oscillations of the same amplitude and period; it defines at what time the oscillation starts. Figure 157 shows how a harmonic oscillation is related to an imaginary rotation. As a result, the phase is best described by an angle between  $0$  and  $2\pi$ .

All systems that oscillate also emit waves. In fact, oscillations only appear in extended systems, and oscillations are only the simplest of motions of extended systems. The general repetitive motion of an extended system is the wave.





**FIGURE 159** A general *periodic* signal (black square wave) can be decomposed uniquely into simplest, or *harmonic* waves. The first three components (green, blue and red) and also their intermediate sum (black dotted line) are shown. This is called a *Fourier decomposition* and the general method to do this *Fourier analysis*. (© Wikimedia) The unique decomposition into harmonic waves is even possible for *non-periodic* signals. The bottom drawing shows the main properties of a harmonic wave.



**FIGURE 160** The measured fundamental vibration patterns of a bell. Bells – like every other source of oscillations, be it an atom, a molecule, a music instrument or the human voice – show that all oscillations in nature are due to waves. (© H. Spiess, al.).

**WAVES AND THEIR MOTION**

Waves are travelling imbalances, or, equivalently, travelling oscillations. Waves move, even though the substrate does not move. Every wave can be seen as a superposition of

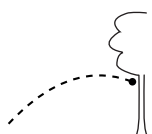




TABLE 38 Some wave velocities.

WAVE	VELOCITY
Tsunami	around 0.2 km/s
Sound in most gases	$0.3 \pm 0.1$ km/s
Sound in air at 273 K	0.331 km/s
Sound in air at 293 K	0.343 km/s
Sound in helium at 293 K	0.983 km/s
Sound in most liquids	$1.2 \pm 0.2$ km/s
Sound in water at 273 K	1.402 km/s
Sound in water at 293 K	1.482 km/s
Sound in sea water at 298 K	1.531 km/s
Sound in gold	4.5 km/s
Sound in steel	5.8 to 5.960 km/s
Sound in granite	5.8 km/s
Sound in glass (longitudinal)	4 to 5.9 km/s
Sound in beryllium (longitudinal)	12.8 km/s
Sound in boron	up to 15 km/s
Sound in diamond	up to 18 km/s
Sound in fullerene (C <sub>60</sub> )	up to 26 km/s
Plasma wave velocity in InGaAs	600 km/s
Light in vacuum	$2.998 \cdot 10^8$ m/s

Challenge 448 e

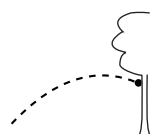
*harmonic* waves. Can you describe the difference in wave shape between a pure harmonic tone, a musical sound, a noise and an explosion? Every sound effect can be thought of as being composed of harmonic waves. Harmonic waves, also called *sine waves* or *linear waves*, are the building blocks of which all internal motions of an extended body are constructed.

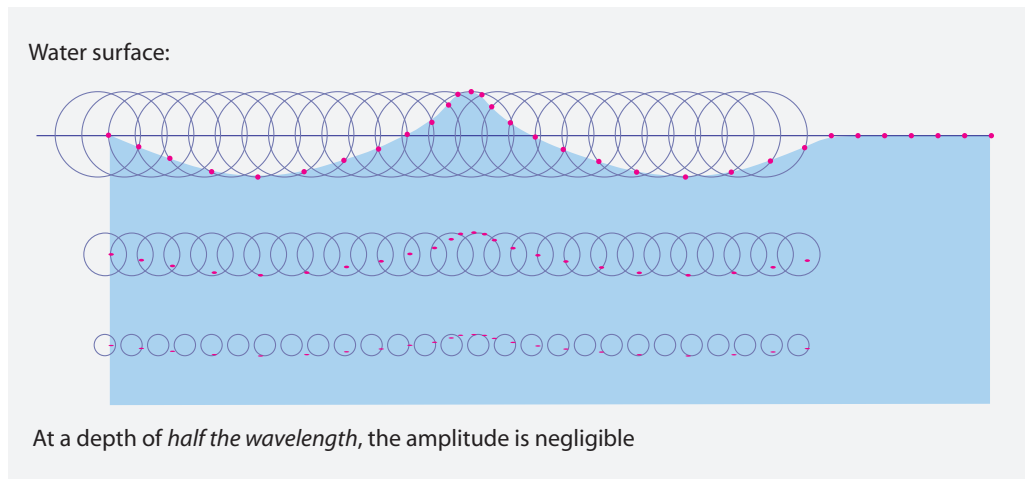
Challenge 449 e

Every harmonic wave is characterized by an oscillation *frequency*  $f$ , a propagation *velocity*  $c$ , a *wavelength*  $\lambda$ , an amplitude  $A$  and a *phase*  $\varphi$ , as can be deduced from Figure 159. Low-amplitude water waves show this most clearly. In a harmonic wave, every position performs a harmonic oscillation. The phase of a wave specifies the position of the wave (or a crest) at a given time. It is an angle between 0 and  $2\pi$ . Can you show that frequency and wavelength in a wave are related by  $f\lambda = c$ ?

Waves appear inside all *extended* bodies, be they solids, liquids, gases or plasmas. Inside fluid bodies, waves are *longitudinal*, meaning that the wave motion is in the same direction as the wave oscillation. Sound in air is an example of a longitudinal wave. Inside solid bodies, waves can also be *transverse*; in that case the wave oscillation is perpendicular to the travelling direction.

Waves appear also on *interfaces* between bodies: water–air interfaces are a well-known case. Even a saltwater–freshwater interface, so-called *dead water*, shows waves: they can appear even if the upper surface of the water is immobile. Any flight in an aeroplane provides an opportunity to study the regular cloud arrangements on the interface between





**FIGURE 161** The formation of the shape of gravity waves on and under water from the circular motion of the water particles.

warm and cold air layers in the atmosphere. Seismic waves travelling along the boundary between the sea floor and the sea water are also well-known. General surface waves are usually neither longitudinal nor transverse, but of a mixed type.

On water surfaces, one classifies waves according to the force that restores the plane surface. The first type, *surface tension waves*, plays a role on scales up to a few centimetres. At longer scales, gravity takes over as the main restoring force and one speaks of *gravity waves*. This is the type we focus on here. Gravity waves in water, in contrast to surface tension waves, are not sine waves. This is because of the special way the water moves in such a wave. As shown in **Figure 161**, the surface water for a (short) water wave moves in circles; this leads to the typical, asymmetrical wave shape with short sharp crests and long shallow troughs. (As long as there is no wind and the floor below the water is horizontal, the waves are also symmetric under front-to-back reflection.)

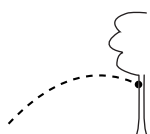
Page 237

For water gravity waves, as for many other waves, the speed depends on the wavelength. Experiments show that the speed  $c$  of water waves depends on the wavelength  $\lambda$  and on the depth of the water  $d$  in the following way:

$$c = \sqrt{\frac{g\lambda}{2\pi} \tanh \frac{2\pi d}{\lambda}}, \tag{92}$$

where  $g$  is the acceleration due to gravity (and an amplitude much smaller than the wavelength is assumed\*). The formula shows two limiting regimes. First, so-called *short* or *deep waves* appear when the water depth is larger than half the wavelength; for deep waves, the phase velocity is  $c \approx \sqrt{g\lambda/2\pi}$ , thus wavelength dependent, and the group velocity is about half the phase velocity. Shorter deep waves are thus slower. Secondly, *shallow* or *long waves* appear when the depth is less than 5% of the wavelength; in this case,  $c \approx \sqrt{gd}$ , there is no dispersion, and the group velocity is about the same as the phase

\* The expression for the phase velocity can also be derived by solving for the motion of the liquid in the linear regime, but leads us too far from our walk.



velocity. The most impressive shallow waves are tsunamis, the large waves triggered by submarine earthquakes. (The Japanese name is composed of *tsu*, meaning harbour, and *nami*, meaning wave.) Since tsunamis are shallow waves, they show little dispersion and thus travel over long distances; they can go round the Earth several times. Typical oscillation times are between 6 and 60 minutes, giving wavelengths between 70 and 700 km and speeds in the open sea of 200 to 250 m/s, similar to that of a jet plane. Their amplitude on the open sea is often of the order of 10 cm; however, the amplitude scales with depth  $d$  as  $1/d^4$  and heights up to 40 m have been measured at the shore. This was the order of magnitude of the large and disastrous tsunami observed in the Indian Ocean on 26 December 2004.

Challenge 450 e

Waves can also exist in empty space. Both light and gravity waves are examples. The exploration of electromagnetism and relativity will tell us more about their properties.

Any study of motion must include the study of wave motion. We know from experience that waves can hit or even damage targets; thus every wave carries energy and momentum, even though (on average) no matter moves along the wave propagation direction. The *energy*  $E$  of a wave is the sum of its kinetic and potential energy. The kinetic energy (density) depends on the temporal change of the displacement  $u$  at a given spot: rapidly changing waves carry a larger kinetic energy. The potential energy (density) depends on the gradient of the displacement, i.e., on its spatial change: steep waves carry a larger potential energy than shallow ones. (Can you explain why the potential energy does not depend on the displacement itself?) For harmonic waves propagating along the direction  $z$ , each type of energy is proportional to the square of its respective displacement change:

Challenge 451 s

Ref. 193

$$E \sim \left(\frac{\partial u}{\partial t}\right)^2 + v^2 \left(\frac{\partial u}{\partial z}\right)^2. \quad (93)$$

Challenge 452 ny

How is the energy density related to the frequency?

The *momentum* of a wave is directed along the direction of wave propagation. The momentum value depends on both the temporal and the spatial change of displacement  $u$ . For harmonic waves, the momentum (density)  $P$  is proportional to the product of these two quantities:

$$P_z \sim \frac{\partial u}{\partial t} \frac{\partial u}{\partial z}. \quad (94)$$

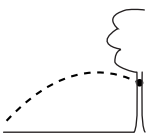
Challenge 453 s

When two linear wave trains collide or interfere, the total momentum is conserved throughout the collision. An important consequence of momentum conservation is that waves that are reflected by an obstacle do so with an outgoing angle equal to minus the infalling angle. What happens to the phase?

Challenge 454 ny

In summary, waves, like moving bodies, carry energy and momentum. In simple terms, if you shout against a wall, the wall is hit. This hit, for example, can start avalanches on snowy mountain slopes. In the same way, waves, like bodies, can carry also angular momentum. (What type of wave is necessary for this to be possible?) However, we can distinguish six main properties that set the motion of waves apart from the motion of bodies.

— Waves can add up or cancel each other out; thus they can interpenetrate each other.



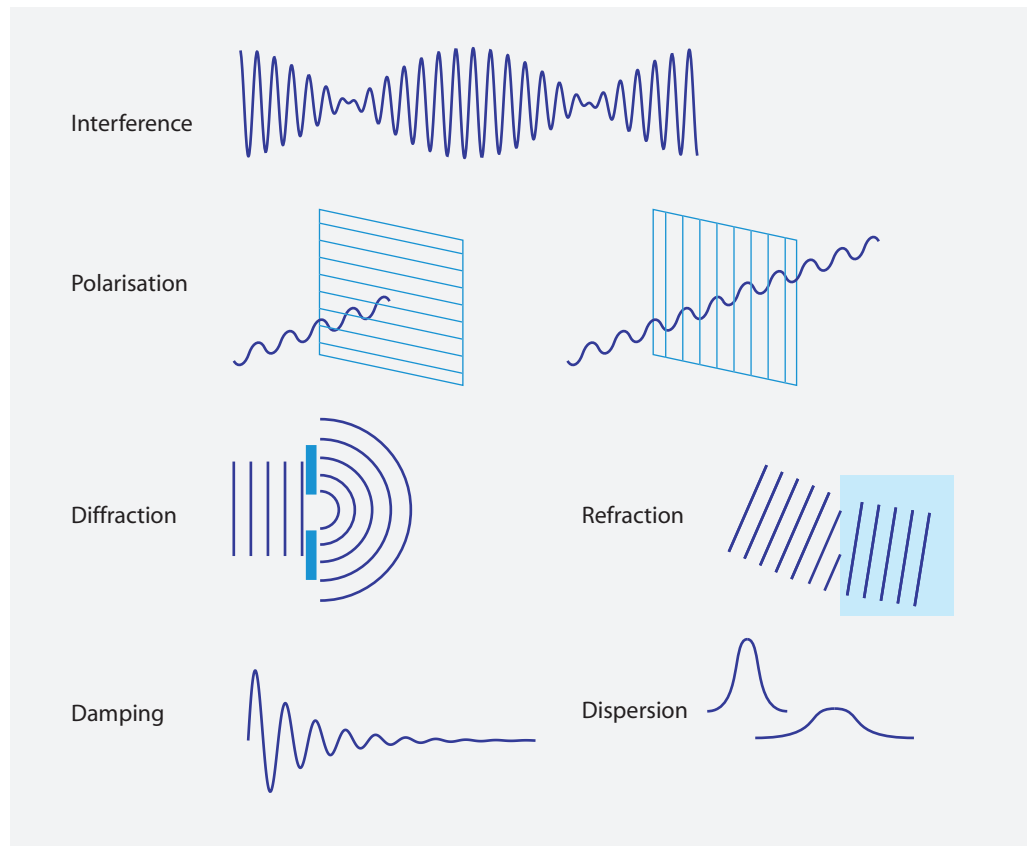


FIGURE 162 The six main properties of the motion of waves.

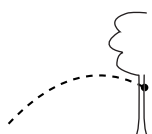
These effects, called *superposition* and *interference*, are strongly tied to the linearity of most waves.

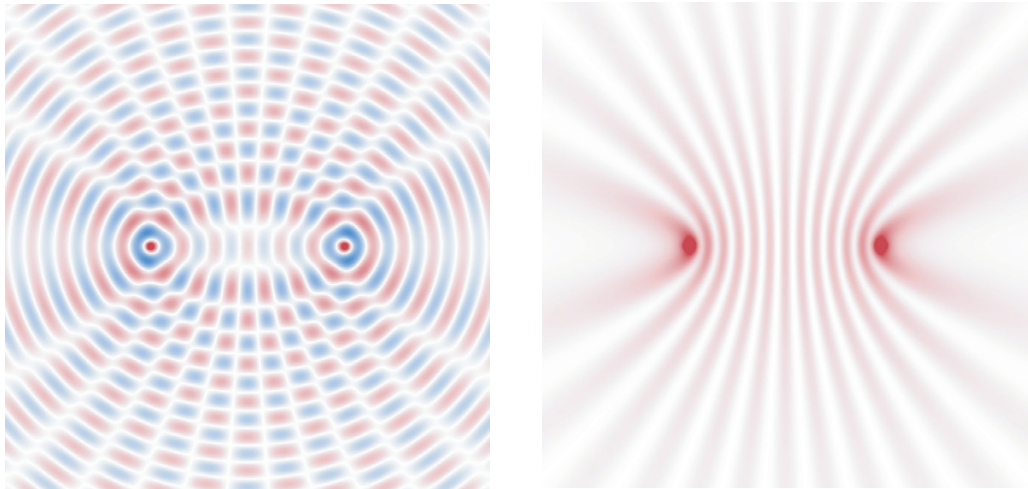
- Transverse waves in three dimensions can oscillate in different directions: they show *polarization*.
- Waves, such as sound, can go around corners. This is called *diffraction*.
- Waves change direction when they change medium. This is called *refraction*.
- Waves can have a frequency-dependent propagation speed. This is called *dispersion*.
- Often, the wave amplitude decreases over time: waves show *damping*.

Material bodies in everyday life do not behave in these ways when they move. These six wave effects appear because wave motion is the motion of *extended* entities. The famous debate whether electrons or light are waves or particles thus requires us to check whether these effects specific to waves can be observed or not. This is one topic of quantum theory. Before we study it, can you give an example of an observation that implies that a motion surely cannot be a wave?

Challenge 455 s

As a result of having a frequency  $f$  and a propagation velocity  $v$ , all sine waves are characterized by the distance  $\lambda$  between two neighbouring wave crests: this distance is





**FIGURE 163** Interference of two circular or spherical waves emitted in phase: a snapshot of the amplitude (left), most useful to describe observations of water waves, and the distribution of the time-averaged intensity (right), most useful to describe interference of light waves (© Rüdiger Paschotta).

called the wavelength. All waves obey the basic relation

$$\lambda f = v . \quad (95)$$

In many cases the wave velocity  $v$  depends on the wavelength of the wave. For example, this is the case for water waves. This change of speed with wavelength is called *dispersion*. In contrast, the speed of sound in air does not depend on the wavelength (to a high degree of accuracy). Sound in air shows almost no dispersion. Indeed, if there were dispersion for sound, we could not understand each other's speech at larger distances.

In everyday life we do not experience light as a wave, because the wavelength is only around one two-thousandth of a millimetre. But light shows all six effects typical of wave motion. A rainbow, for example, can only be understood fully when the last five wave effects are taken into account. Diffraction and interference can even be observed with your fingers only. Can you tell how?

Vol. III, page 83

Challenge 456 s

Like every anharmonic oscillation, every anharmonic wave can be decomposed into sine waves. **Figure 159** gives examples. If the various sine waves contained in a disturbance propagate differently, the original wave will change in shape while it travels. That is the reason why an echo does not sound exactly like the original sound; for the same reason, a nearby thunder and a far-away one sound different.

All systems which oscillate also emit waves. Any radio or TV receiver contains oscillators. As a result, any such receiver is also a (weak) transmitter; indeed, in some countries the authorities search for people who listen to radio without permission listening to the radio waves emitted by these devices. Also, inside the human ear, numerous tiny structures, the hair cells, oscillate. As a result, the ear must also emit sound. This prediction, made in 1948 by Tommy Gold, was finally confirmed in 1979 by David Kemp. These so-called *otoacoustic emissions* can be detected with sensitive microphones; they

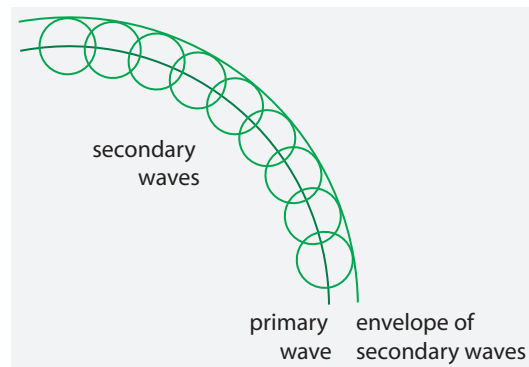


FIGURE 164 Wave propagation as a consequence of Huygens' principle.

Ref. 194

are presently being studied in order to unravel the still unknown workings of the ear and in order to diagnose various ear illnesses without the need for surgery.

Since any travelling disturbance can be decomposed into sine waves, the term 'wave' is used by physicists for all travelling disturbances, whether they look like sine waves or not. In fact, the disturbances do not even have to be travelling. Take a standing wave: is it a wave or an oscillation? Standing waves do not travel; they are oscillations. But a standing wave can be seen as the superposition of two waves travelling in opposite directions. But in nature, any object that we call 'oscillating' or 'vibrating' is extended, and the oscillation or vibration is always a standing wave (can you confirm this?); so we can say that in nature, *all oscillations are special forms of waves*.

Challenge 457 e

The most important travelling disturbances are those that are localized. Figure 159 shows an example of a localized wave group or pulse, together with its decomposition into harmonic waves. Wave groups are extensively used to talk and as signals for communication.

### WHY CAN WE TALK TO EACH OTHER? – HUYGENS' PRINCIPLE

The properties of our environment often disclose their full importance only when we ask simple questions. Why can we use the radio? Why can we talk on mobile phones? Why can we listen to each other? It turns out that a central part of the answer to these questions is that the space we live has an *odd* numbers of dimensions.

In spaces of *even* dimension, it is impossible to talk, because messages do not stop. This is an important result which is easily checked by throwing a stone into a lake: even after the stone has disappeared, waves are still emitted from the point at which it entered the water. Yet, when we stop talking, no waves are emitted any more. Waves in two and three dimensions thus behave differently.

In three dimensions, it is possible to say that the propagation of a wave happens in the following way: Every point on a wave front (of light or of sound) can be regarded as the source of secondary waves; the surface that is formed by the envelope of all the secondary waves determines the future position of the wave front. The idea is illustrated in Figure 164. It can be used to describe, without mathematics, the propagation of waves, their reflection, their refraction, and, with an extension due to Augustin Fresnel, their diffraction. (Try!)

Challenge 458 e

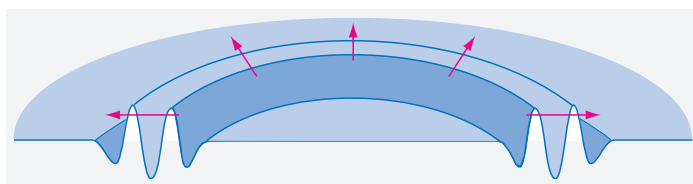


FIGURE 165 An impossible water wave: the centre is never flat.

This idea was first proposed by Christiaan Huygens in 1678 and is called *Huygens' principle*. Almost two hundred years later, Gustav Kirchhoff showed that the principle is a consequence of the wave equation in three dimensions, and thus, in the case of light, a consequence of Maxwell's field equations.

But the description of wave fronts as envelopes of secondary waves has an important limitation. It is not correct in two dimensions (even though Figure 164 is two-dimensional!). In particular, it does not apply to water waves. Water wave propagation *cannot* be calculated in this way in an exact manner. (It is only possible if the situation is limited to a wave of a single frequency.) It turns out that for water waves, secondary waves do not only depend on the wave front of the primary waves, but depend also on their interior. The reason is that in two (and other even) dimensions, waves of different frequency necessarily have different speeds. And a stone falling into water generates waves of many frequencies. In contrast, in three (and larger odd) dimensions, waves of all frequencies have the same speed.

We can also say that Huygens' principle holds if the wave equation is solved by a circular wave leaving no amplitude behind it. Mathematicians translate this by requiring that the evolving delta function  $\delta(c^2 t^2 - r^2)$  satisfies the wave equation, i.e., that  $\partial_t^2 \delta = c^2 \Delta \delta$ . The delta function is that strange 'function' which is zero everywhere except at the origin, where it is infinite. A few more properties describe the precise way in which this happens.\* It turns out that the delta function is a solution of the wave equation only if the space dimension is odd and at least three. In other words, while a spherical wave pulse is possible, a circular pulse is not: there is no way to keep the centre of an expanding wave quiet. (See Figure 165.) That is exactly what the stone experiment shows. You can try to produce a circular pulse (a wave that has only a few crests) the next time you are in the bathroom or near a lake: you will not succeed.

In summary, the reason a room gets dark when we switch off the light, is that we live in a space with a number of dimensions which is odd and larger than one.

### WHY IS MUSIC SO BEAUTIFUL?

Music works because it connects to emotions. And it does so, among others, by reminding us of the sounds (and emotions connected to them) that we experienced before birth. Percussion instruments remind us of the heart beat of our mother and ourselves, cord and wind instruments remind us of all the voices we heard back then. Musical instruments are especially beautiful if they are driven and modulated by the body of the player. All classical instruments are optimized to allow this modulation and the ability to express emotions in this way.

\* The main property is  $\int \delta(x) dx = 1$ . In mathematically precise terms, the delta 'function' is a distribution.



TABLE 39 Some signals.

SYSTEM	SIGNAL	SPEED	SENSOR
<b>Matter signals</b>			
Human	voltage pulses in nerves	up to 120 m/s	brain, muscles
	hormones in blood stream	up to 0.3 m/s	molecules on cell membranes
	immune system signals	up to 0.3 m/s	molecules on cell membranes
	singing	340 m/s	ear
Elephant, insects	soil trembling	c. 2 km/s	feet
Whale	singing, sonar	1500 m/s	ear
Dog	chemical tracks	1 m/s	nose
Butterfly	chemical mating signal carried by the wind	up to 10 m/s	antennae
Tree	chemical signal of attack carried by the air from one tree to the next	up to 10 m/s	leaves
Erratic block	carried by glacier	up to 0.1 $\mu\text{m/s}$	foot
Post	paper letters transported by trucks, ships and planes	up to 300 m/s	mail box
<b>Electromagnetic fields</b>			
Humans	yawning	300 Mm/s	eye
Electric eel	voltage pulse	up to 300 Mm/s	nerves
Insects, fish, molluscs	light pulse sequence	up to 300 Mm/s	eye
Flag signalling	orientation of flags	300 Mm/s	eye
Radio transmissions	electromagnetic field strength	up to 300 Mm/s	radio
<b>Nuclear signals</b>			
Supernovas	neutrino pulses	close to 300 Mm/s	specific chemical and radiation detectors
Nuclear reactions	glueballs, if they exist	close to 300 Mm/s	custom particle detectors

The connection between the musician and the instrument is most intense for the human voice; the next approximation are the wind instruments. In all these cases, the breath of the singer or player does two things: it provides the energy for the sound and it gives



Equal-tempered frequency ratio	1	1.059	1.122	1.189	1.260	1.335	1.414	1.498	1.587	1.682	1.782	1.888	2
Just intonation frequency ratio	1		9/8	6/5	5/4	4/3	none	3/2	8/5	5/3		15/8	2
Appears as harmonic nr.		1,2,4,8	9		5, 10			3, 6			c. 7	15	1,2,4,8

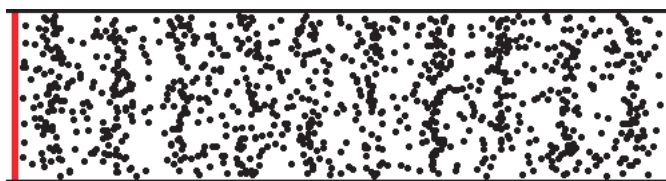
Italian and international solfège names	<b>Do</b> Si#	Do# Reb	<b>Re</b>	Re# Mi b	<b>Mi</b> Fab	Fa Mi#	Fa# Solb	<b>Sol</b>	Sol# Lab	<b>La</b>	La# Sib	<b>Si</b> Dob	<b>Do</b> Si#
French names	Ut Si#	Ut # Reb	Re	Re # Mi b	Mi Fab	Fa Mi#	Fa # Solb	Sol	Sol # Lab	La	La # Sib	Si Ut b	Ut Si#
German names	C His	Cis Des	D	Dis Es	E Fes	F Eis	Fis Ges	G	Gis As	A	Ais B	H Ces	C His
English names	C B#	C# Db	D	D# Eb	E Fb	F E#	F# Gb	G	G# Ab	A	A# Bb	B Cb	C B#
Interval name, starting from Do / Ut / C	uni- son	min. 2nd	maj. 2nd	min. 3rd	maj. 3rd	4th	triton	5th	min. 6th	maj. 6th	min. 7th	maj. 7th	octave
Pianoforte keys													

FIGURE 166 The twelve notes used in music and their frequency ratios.

an input for the feedback loop that sets the pitch. While singing, the air passes the vocal cords. The rapid air flow reduces the air pressure, which attracts the cords to each other and thus reduces the cross section for the air flow. (This pressure reduction is described by the Bernoulli equation, as explained below.) As a result of the smaller cross section, the airflow is reduced, the pressure rises again, and the vocal cords open up again. This leads to larger airflow, and the circle starts again. The change between larger and smaller cord distance repeats so rapidly that sound is produced; the sound is then amplified in the mouth by the resonances that depend on the shape of the oral cavity.

**Page 273** In *reed instruments*, such as the clarinet, the reed has the role of the vocal cords, and the pipe and the mechanisms have the role of the mouth. In *brass instruments*, such as the trombone, the lips play the role of the reed. In *airflow instruments*, such as the flute, the feedback loop is due to another effect: at the sound-producing edge, the airflow is deflected by the sound itself.

**Ref. 195** The second reason that music is beautiful is due to the way the frequencies of the notes are selected. Certain frequencies sound agreeable to the ear when they are played together or closely after each other; other produce a sense of tension. Already the an-



**FIGURE 167** A schematic animation of a vibrating membrane (drawn in red), from a drum or a loudspeaker, generating a sound wave in air, and showing the molecular motion (Wikicommons)

cient Greek had discovered that these sensations depend exclusively on the *ratio* of the frequencies, or as musician say, on the *interval* between the pitches.

More specifically, a frequency ratio of 2 – musicians call the interval an *octave* – is the most agreeable consonance. A ratio of  $3/2$  (called perfect fifth) is the next most agreeable, followed by the ratio  $4/3$  (a perfect fourth), the ratio  $5/4$  (a major third) and the ratio  $6/5$  (a minor third). The choice of the first third in a scale has an important effect on the average emotions expressed by the music and is therefore also taken over in the name of the scale. Songs in C major generally have a more happy tune, whereas songs in A minor tend to sound sadder.

The least agreeable frequency ratios, the dissonances, are the *tritone* ( $7/5$ , also called *augmented fourth* or *diminished fifth*) and, to a lesser extent, the major and minor seventh ( $15/8$  and  $9/5$ ). The false quint is used for the siren in German red cross vans. Long sequences of dissonances have the effect to induce trance; they are common in Balinese music and in jazz.

After centuries of experimenting, these results lead to a standardized arrangement of the notes and their frequencies that is shown in [Figure 166](#). The arrangement, called the *equal intonation* or *well-tempered intonation*, contains approximations to all the mentioned intervals; the approximations have the advantage that they allow the *transposition* of music to lower or higher notes. This is not possible with the ideal, so-called *just intonation*.

Ref. 196

Challenge 459 e

The next time you sing a song that you like, you might try to determine whether you use just or equal intonation – or a different intonation altogether. Different people have different tastes and habits.

### IS ULTRASOUND IMAGING SAFE FOR BABIES?

Ultrasound is used in medicine to explore the interior of human bodies. The technique, called ultrasound imaging, is helpful, convenient and widespread, as shown in [Figure 168](#). However, it has a disadvantage. Studies at the Mayo Clinic in Minnesota have found that *pulsed* ultrasound, in contrast to *continuous* ultrasound, produces extremely high levels of audible sound inside the body.

Ref. 197

Pulsed ultrasound is used in ultrasound imaging, and in some, but not all, foetal heart-beat monitors. Such machines thus produce high levels of sound in the *audible* range. This seems paradoxical; if you go to a gynecologist and put the ultrasound head on your ear or head, you will only hear a very faint noise. In fact, it is this low intensity that tricks everybody to think that the noise level is low. The noise level is only low because the human ear is full of air. In contrast, in a foetus, the ear is filled with liquid. This fact changes



**FIGURE 168** A modern ultrasound imaging system, and a common, but harmful ultrasound image of a foetus (© General Electric, Wikimedia).

the propagation of sound completely: the sound generated by imaging machines is now fully focused and directly stimulates the inner ear. The total effect is similar to what happens if you put your finger in your ear: this can be very loud to yourself, but nobody else can hear what happens.

Ref. 197 Recent research has shown that sound levels of over 100 dB, corresponding to a subway train entering the station, are generated by ultrasound imaging systems. Indeed, every gynecologist will confirm that imaging disturbs the foetus. Questioned about this issue, several makers of ultrasound imaging devices confirmed that “a sound output of *only* 5 mW is used”. That is ‘only’ the acoustic power of an oboe at full power! Since many ultrasound examinations take ten minutes and more, a damage to the ear of the foetus cannot be excluded. It is not sensible to expose a baby to this level of noise without good reason.

Ref. 198 In short, ultrasound should be used for pregnant mothers only in case of necessity. Ultrasound is *not safe* for the ears of foetuses. In all other situations, ultrasound imaging seems safe. It should be noted however, that another potential problem of ultrasound imaging, the issue of tissue damage through cavitation, has not been explored in detail yet.

Ref. 199

## SIGNALS

A signal is the transport of information. Every signal, including those from Table 39, is motion of energy. Signals can be either objects or waves. A thrown stone can be a signal, as can a whistle. Waves are a more practical form of communication because they do not require transport of matter: it is easier to use electricity in a telephone wire to transport a statement than to send a messenger. Indeed, most modern technological advances can be traced to the separation between signal and matter transport. Instead of transporting an orchestra to transmit music, we can send radio signals. Instead of sending paper letters we write email messages. Instead of going to the library we browse the internet.

The greatest advances in communication have resulted from the use of signals to transport large amounts of energy. That is what electric cables do: they transport energy with-

out transporting any (noticeable) matter. We do not need to attach our kitchen machines to the power station: we can get the energy via a copper wire.

For all these reasons, the term 'signal' is often meant to imply waves only. Voice, sound, electric signals, radio and light signals are the most common examples of wave signals.

Vol. II, page 14

Signals are characterized by their speed and their information content. Both quantities turn out to be limited. The limit on speed is the central topic of the theory of special relativity.

A simple limit on information content can be expressed when noting that the information flow is given by the detailed shape of the signal. The shape is characterized by a frequency (or wavelength) and a position in time (or space). For every signal – and every wave – there is a relation between the time-of-arrival error  $\Delta t$  and the angular frequency error  $\Delta\omega$ :

$$\Delta t \Delta\omega \geq \frac{1}{2}. \quad (96)$$

Challenge 460 e

This time–frequency indeterminacy relation expresses that, in a signal, it is impossible to specify both the time of arrival and the frequency with full precision. The two errors are (within a numerical factor) the inverse of each other. (One also says that the time–bandwidth product is always larger than  $1/4\pi$ .) The limitation appears because on the one hand one needs a wave as similar as possible to a sine wave in order to precisely determine the frequency, but on the other hand one needs a signal as narrow as possible to precisely determine its time of arrival. The contrast in the two requirements leads to the limit. The indeterminacy relation is thus a feature of every wave phenomenon. You might want to test this relation with any wave in your environment.

Similarly, there is a relation between the position error  $\Delta x$  and the wave vector error  $\Delta k = 2\pi/\Delta\lambda$  of a signal:

$$\Delta x \Delta k \geq \frac{1}{2}. \quad (97)$$

Like the previous case, also this indeterminacy relation expresses that it is impossible to specify both the position of a signal and its wavelength with full precision. Also this position–wave-vector indeterminacy relation is a feature of any wave phenomenon.

Every indeterminacy relation is the consequence of a smallest entity. In the case of waves, the smallest entity of the phenomenon is the period (or cycle, as it used to be called). Whenever there is a smallest unit in a natural phenomenon, an indeterminacy relation results. We will encounter other indeterminacy relations both in relativity and in quantum theory. As we will find out, they are due to smallest entities as well.

Challenge 461 ny

Whenever signals are sent, their content can be lost. Each of the six characteristics of waves listed on [page 240](#) can lead to content degradation. Can you provide an example for each case? The energy, the momentum and all other conserved properties of signals are never lost, of course. The disappearance of signals is akin to the disappearance of motion. When motion disappears by friction, it only seems to disappear, and is in fact transformed into heat. Similarly, when a signal disappears, it only seems to disappear, and is in fact transformed into noise. (*Physical*) noise is a collection of numerous disordered signals, in the same way that heat is a collection of numerous disordered movements.

All signal propagation is described by a wave equation. A famous example is the set

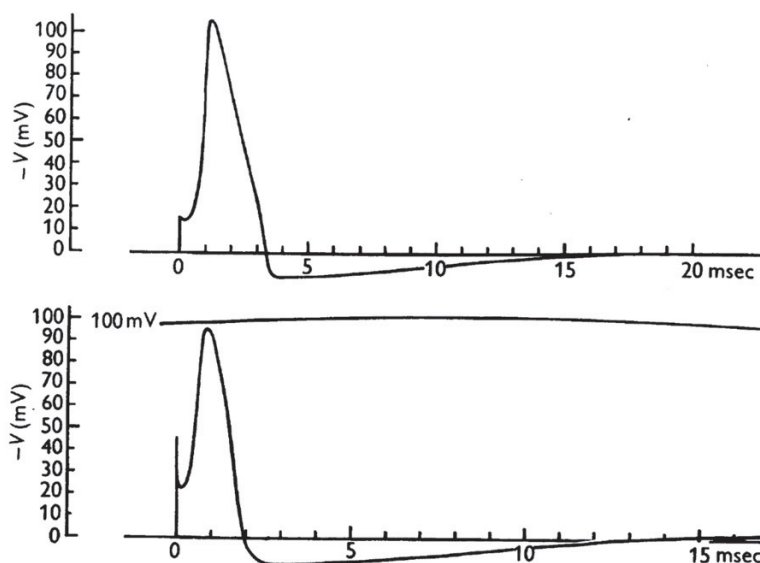


Fig. 13. Upper curve: solution of eqn. (26) for initial depolarization of 15 mV, calculated for 6° C. Lower curve: tracing of membrane action potential recorded at 9.1° C (axon 14). The vertical scales are the same in both curves (apart from curvature in the lower record). The horizontal scales differ by a factor appropriate to the temperature difference.

FIGURE 169 The electrical signals calculated (above) and measured (below) in a nerve, following Hodgkin and Huxley.

Ref. 200 of equations found by Hodgkin and Huxley. It is a realistic approximation for the behaviour of electrical potential in nerves. Using facts about the behaviour of potassium and sodium ions, they found an elaborate wave equation that describes the voltage  $V$  in nerves, and thus the way the signals are propagated. The equation describes the characteristic voltage spikes measured in nerves, shown in Figure 169. The figure clearly shows that these waves differ from sine waves: they are not harmonic. Anharmonicity is one result of nonlinearity. But nonlinearity can lead to even stronger effects.

#### SOLITARY WAVES AND SOLITONS

In August 1834, the Scottish engineer John Scott Russell (1808–1882) recorded a strange observation in a water canal in the countryside near Edinburgh. When a boat pulled through the channel was suddenly stopped, a strange water wave departed from it. It consisted of a *single* crest, about 10 m long and 0.5 m high, moving at about 4 m/s. He followed that crest, shown in a reconstruction in Figure 170, with his horse for several kilometres: the wave died out only very slowly. Russell did not observe any dispersion, as is usual in water waves: the width of the crest remained constant. Russell then started producing such waves in his laboratory, and extensively studied their properties. He showed that the speed depended on the amplitude, in contrast to linear, harmonic waves. He also found that the depth  $d$  of the water canal was an important parameter. In fact, the speed

Ref. 201





**FIGURE 170** A solitary water wave followed by a motor boat, reconstructing the discovery by Scott Russel (© Dugald Duncan).

$v$ , the amplitude  $A$  and the width  $L$  of these single-crested waves are related by

$$v = \sqrt{gd} \left( 1 + \frac{A}{2d} \right) \quad \text{and} \quad L = \sqrt{\frac{4d^3}{3A}}. \quad (98)$$

As shown by these expressions, and noted by Russell, high waves are narrow and fast, whereas shallow waves are slow and wide. The shape of the waves is fixed during their motion. Today, these and all other stable waves with a single crest are called *solitary waves*. They appear only where the dispersion and the nonlinearity of the system exactly compensate for each other. Russell also noted that the solitary waves in water channels can cross each other unchanged, even when travelling in opposite directions; solitary waves with this property are called *solitons*. In short, solitons are stable against encounters, as shown in [Figure 171](#), whereas solitary waves in general are not.

Only sixty years later, in 1895, Korteweg and de Vries found out that solitary waves in water channels have a shape described by

$$u(x, t) = A \operatorname{sech}^2 \frac{x - vt}{L} \quad \text{where} \quad \operatorname{sech} x = \frac{2}{e^x + e^{-x}}, \quad (99)$$

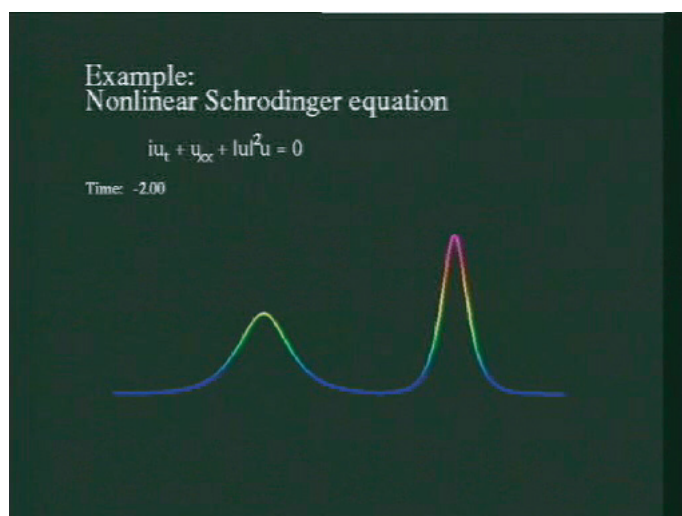
and that the relation found by Russell was due to the wave equation

$$\frac{1}{\sqrt{gd}} \frac{\partial u}{\partial t} + \left( 1 + \frac{3}{2d} u \right) \frac{\partial u}{\partial x} + \frac{d^2}{6} \frac{\partial^3 u}{\partial x^3} = 0. \quad (100)$$

This equation for the elongation  $u$  is called the *Korteweg–de Vries equation* in their honour.\* The surprising stability of the solitary solutions is due to the opposite effect of the

\* The equation can be simplified by transforming the variable  $u$ ; most concisely, it can be rewritten as  $u_t +$





**FIGURE 171** Solitons are stable against encounters (QuickTime film © Jarmo Hietarinta)

two terms that distinguish the equation from linear wave equations: for the solitary solutions, the nonlinear term precisely compensates for the dispersion induced by the third-derivative term.

For many decades such solitary waves were seen as mathematical and physical curiosities. But almost a hundred years later it became clear that the Korteweg–de Vries equation is a universal model for weakly nonlinear waves in the weak dispersion regime, and thus of basic importance. This conclusion was triggered by Kruskal and Zabusky, who in 1965 proved mathematically that the solutions (99) are unchanged in collisions. This discovery prompted them to introduce the term *soliton*. These solutions do indeed interpenetrate one another without changing velocity or shape: a collision only produces a small positional shift for each pulse.

Solitary waves play a role in many examples of fluid flows. They are found in ocean currents; and even the red spot on Jupiter, which was a steady feature of Jupiter photographs for many centuries, is an example.

Solitary waves also appear when extremely high-intensity sound is generated in solids. In these cases, they can lead to sound pulses of only a few nanometres in length. Solitary light pulses are also used inside certain optical communication fibres, where the lack of dispersion allows higher data transmission rates than are achievable with usual light pulses.

Towards the end of the twentieth century a second wave of interest in the mathematics of solitons arose, when quantum theorists became interested in them. The reason is simple but deep: a soliton is a ‘middle thing’ between a particle and a wave; it has features of both concepts. For this reason, solitons are seen as candidates for the description of elementary particles.

---

$u_{xxx} = 6uu_x$ . As long as the solutions are sech functions, this and other transformed versions of the equation are known by the same name.

## CURIOSITIES AND FUN CHALLENGES ABOUT WAVES AND EXTENDED BODIES

“ Society is a wave. The wave moves onward, but the water of which it is composed does not. ”  
 Ralph Waldo Emerson, *Self-Reliance*.

Challenge 462 e When the frequency of a tone is doubled, one says that the tone is higher by an octave. Two tones that differ by an octave, when played together, sound pleasant to the ear. Two other agreeable frequency ratios – or ‘intervals’, as musicians say – are quarts and quints. What are the corresponding frequency ratios? (Note: the answer was one of the oldest discoveries in physics and perception research; it is attributed to Pythagoras, around 500 B.C.E.)

\* \*

Ref. 203 Also the bumps of skiing slopes, the so-called *ski moguls*, are waves. Ski moguls are essential in many winter Olympic disciplines. Observation shows that ski moguls have a wavelength of typically 5 to 6 m and that they move with an average speed of 8 cm/day. Surprisingly, the speed is directed *upwards*, towards the top of the skiing slope. Can you explain why this is so? In fact, ski moguls are also an example of self-organization; this topic will be covered in more detail below.

Challenge 463 s  
 Page 318

\* \*

Challenge 464 s An orchestra is playing music in a large hall. At a distance of 30 m, somebody is listening to the music. At a distance of 3000 km, another person is listening to the music via the radio. Who hears the music first?

\* \*

Challenge 465 ny What is the period of a simple pendulum, i.e., a mass  $m$  attached to a massless string of length  $l$ ? What is the period if the string is much longer than the radius of the Earth?

\* \*

Challenge 466 s What path is followed by a body that moves without friction on a plane, but that is attached by a spring to a fixed point on the plane?

\* \*

The blue whale, *Balaenoptera musculus*, is the *loudest* animal found in nature: its voice can be heard at a distance of hundreds of kilometres.

\* \*

Challenge 467 e A device that shows how rotation and oscillation are linked is the alarm *siren*. Find out how it works, and build one yourself.

\* \*

Challenge 468 e Light is a wave, as we will discover later on. As a result, light reaching the Earth from space is refracted when it enters the atmosphere. Can you confirm that as a result, stars appear somewhat higher in the night sky than they really are?

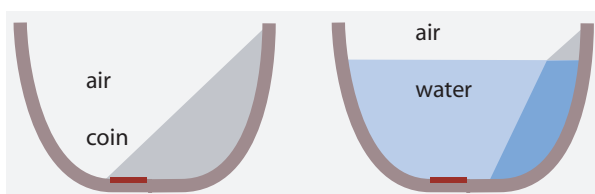


FIGURE 172 Shadows show the refraction of light.

\* \*

Ref. 206

What are the highest sea waves? This question has been researched systematically only recently, using satellites. The surprising result is that sea waves with a height of 25 m and more are *common*: there are a few such waves on the oceans at any given time. This result confirms the rare stories of experienced ship captains and explains many otherwise ship sinkings.

Surfers may thus get many chances to ride 30 m waves. (The record is just below this height.) But maybe the most impressive waves to surf are those of the Pororoça, a series of 4 m waves that move from the sea into the Amazon River every spring, against the flow of the river. These waves can be surfed for tens of kilometres.

\* \*

Challenge 469 s

All waves are damped, eventually. This effect is often frequency-dependent. Can you provide a confirmation of this dependence in the case of sound in air?

\* \*

Challenge 470 e

When you make a hole with a needle in black paper, the hole can be used as a magnifying lens. (Try it.) Diffraction is responsible for the lens effect. By the way, the diffraction of light by holes was noted already by Francesco Grimaldi in the seventeenth century; he correctly deduced that light is a wave. His observations were later discussed by Newton, who wrongly dismissed them.

\* \*

Vol. III, page 126

Put an empty cup near a lamp, in such a way that the bottom of the cup remains in the shadow. When you fill the cup with water, some of the bottom will be lit, because of the refraction of the light from the lamp. The same effect allows us to build lenses. The same effect is at the basis of instruments such as the telescope.

\* \*

Challenge 471 s

Are water waves transverse or longitudinal?

\* \*

The speed of water waves limits the speeds of ships. A surface ship cannot travel (much) faster than about  $v_{\text{crit}} = \sqrt{0.16gl}$ , where  $g = 9.8 \text{ m/s}^2$ ,  $l$  is its length, and 0.16 is a number determined experimentally, called the *critical Froude number*. This relation is valid for all vessels, from large tankers ( $l = 100 \text{ m}$  gives  $v_{\text{crit}} = 13 \text{ m/s}$ ) down to ducks ( $l = 0.3 \text{ m}$  gives  $v_{\text{crit}} = 0.7 \text{ m/s}$ ). The critical speed is that of a wave with the same wavelength as

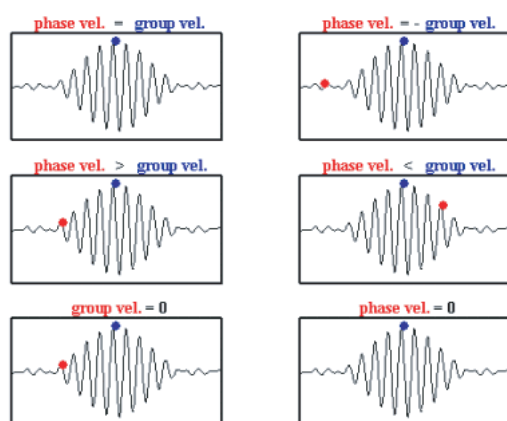


FIGURE 173 A visualisation of group velocity (blue) and phase velocity (red) for different types of waves (QuickTime film © ISVR, University of Southampton)

#### Challenge 472 s

the ship. In fact, moving a ship at higher speeds than the critical value is possible, but requires much more energy. (A higher speed is also possible if the ship surfs on a wave.) How far away is the crawl *olympic swimming* record from the critical value?

Most water animals and ships are faster when they swim below the surface – where the limit due to surface waves does not exist – than when they swim on the surface. For example, ducks can swim three times as fast under water than on the surface.

\* \*

The group velocity of water waves (in deep water) is less than the velocity of the individual wave crests, the so-called *phase velocity*. As a result, when a group of wave crests travels, within the group the crests move from the back to the front: they appear at the back, travel forward and then die out at the front. The group velocity of water waves is lower than its phase velocity.

\* \*

One can hear the distant sea or a distant highway more clearly in the evening than in the morning. This is an effect of refraction. Sound speed increases with temperature. In the evening, the ground cools more quickly than the air above. As a result, sound leaving the ground and travelling upwards is refracted downwards, leading to the long hearing distance typical of evenings. In the morning, usually the air is cold above and warm below. Sound is refracted upwards, and distant sound does not reach a listener on the ground. Refraction thus implies that mornings are quiet, and that we can hear more distant sounds in the evenings. Elephants use the sound situation during evenings to communicate over distances of more than 10 km. (They also use sound waves in the ground to communicate, but that is another story.)

\* \*

Refraction also implies that there is a sound channel in the ocean, and in the atmosphere. Sound speed increases with temperature, and increases with pressure. At an ocean depth of 1 km, or at an atmospheric height of 13 to 17 km (that is at the top of the tallest cu-

mulonimbus clouds or equivalently, at the middle of the ozone layer) sound has *minimal* speed. As a result, sound that starts from that level and tries to leave is channelled back to it. Whales use this *sound channel* to communicate with each other with beautiful songs; one can find recordings of these songs on the internet. The military successfully uses microphones placed at the sound channel in the ocean to locate submarines, and microphones on balloons in the atmospheric channel to listen for nuclear explosions. (In fact, sound experiments conducted by the military are the main reason why whales are deafened and lose their orientation, stranding on the shores. Similar experiments in the air with high-altitude balloons are often mistaken for flying saucers, as in the famous Roswell incident.)

Challenge 473 e

Ref. 207

\* \*

Ref. 208 Also small animals communicate by sound waves. In 2003, it was found that herring communicate using noises they produce when farting. When they pass wind, the gas creates a ticking sound whose frequency spectrum reaches up to 20 kHz. One can even listen to recordings of this sound on the internet. The details of the communication, such as the differences between males and females, are still being investigated. It is possible that the sounds may also be used by predators to detect herring, and they might even be used by future fishing vessels.

\* \*

On windy seas, the white wave crests have several important effects. The noise stems from tiny exploding and imploding water bubbles. The noise of waves on the open sea is thus the superposition of many small explosions. At the same time, white crests are the events where the seas absorb carbon dioxide from the atmosphere, and thus reduce global warming.

\* \*

Challenge 474 s Why are there many small holes in the ceilings of many office rooms?

\* \*

Challenge 475 ny Which quantity determines the wavelength of water waves emitted when a stone is thrown into a pond?

\* \*

Ref. 2 Yakov Perelman lists the following four problems in his delightful physics problem book.

Challenge 476 s (1) A stone falling into a lake produces circular waves. What is the shape of waves produced by a stone falling into a river, where the water flows?

Challenge 477 s (2) It is possible to build a lens for sound, in the same way as it is possible to build lenses for light. What would such a lens look like?

Challenge 478 s (3) What is the sound heard inside a shell?

Challenge 479 s (4) Light takes about eight minutes to travel from the Sun to the Earth. What consequence does this have for the timing of sunrise?

\* \*

Every student probably knows Rubik's cube. Did you deduce how a Rubik's Cube is built

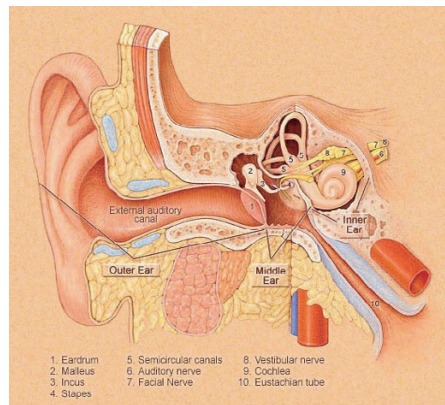


FIGURE 174 The human ear (© Northwestern University).

**Challenge 480 s** without looking at its interior? Also for cubes with other numbers of segments? Is there a limit to the number of segments? These puzzles are even tougher than the search for a rearrangement of the cube.

\* \*

**Challenge 481 ny**

Typically, sound of a talking person produces a pressure variation of 20 mPa on the ear. How is this determined?

The ear is indeed a sensitive device. It is now known that most cases of sea mammals, like whales, swimming onto the shore are due to ear problems: usually some military device (either sonar signals or explosions) has destroyed their ear so that they became deaf and lose orientation.

\* \*

Why is the human ear, shown in [Figure 174](#), so complex? The outer part, the *pinna* or *auricula*, concentrates the sound pressure at the tympanic membrane; it produces a gain of 3 dB. The tympanic membrane, or eardrum, is made in such a way as to always oscillate in fundamental mode, thus without any nodes. The tympanic membrane has a (very wide) resonance at 3 kHz, in the region where the ear is most sensitive. The eardrum transmits its motion, using the ossicles, into the inner ear. This mechanism thus transforms air waves into water waves in the inner ear, where they are detected. (The efficiency with which this transformation takes place is almost ideal; using the language of wave theory, ossicles are thus above all impedance transformers.) Why does the ear transform air waves to water waves? Because the sound wavelength in liquids is much shorter, and allows a small detector; otherwise, the ear would not fit inside the head!

\* \*

**Ref. 209** *Infrasound*, inaudible sound below 20 Hz, is a modern topic of research. In nature, infrasound is emitted by earthquakes, volcanic eruptions, wind, thunder, waterfalls, falling meteorites and the surf. Glacier motion, seaquakes, avalanches and geomagnetic storms also emit infrasound. Human sources include missile launches, traffic, fuel engines and air compressors.

It is known that high intensities of infrasound lead to vomiting or disturbances of the sense of equilibrium (140 dB or more for 2 minutes), and even to death (170 dB for 10 minutes). The effects of lower intensities on human health are not yet known.

Infrasound can travel several times around the world before dying down, as the explosion of the Krakatoa volcano showed in 1883. With modern infrasound detectors, sea surf can be detected hundreds of kilometres away. Sea surf leads to a constant ‘hum’ of the Earth’s crust at frequencies between 3 and 7 mHz. The *Global infrasound Network* uses infrasound to detect nuclear weapon tests, earthquakes and volcanic eruptions, and can count meteorites. Only very rarely can meteorites be heard with the human ear.

\* \*

The method used to deduce the sine waves contained in a signal, as shown in [Figure 159](#), is called the Fourier transformation. It is of importance throughout science and technology. In the 1980s, an interesting generalization became popular, called the *wavelet transformation*. In contrast to Fourier transformations, wavelet transformations allow us to localize signals in time. Wavelet transformations are used to compress digitally stored images in an efficient way, to diagnose aeroplane turbine problems, and in many other applications.

Ref. 210

\* \*

[Challenge 482 r](#) If you like engineering challenges, here is one that is still open. How can one make a robust and efficient system that transforms the energy of sea waves into electricity?

\* \*

If you are interested in ocean waves, you might also enjoy the science of *oceanography*. For an introduction, see the open source textbooks at [oceanworld.tamu.edu](http://oceanworld.tamu.edu).

\* \*

[Challenge 483 r](#) In our description of extended bodies, we assumed that each spot of a body can be followed separately throughout its motion. Is this assumption justified? What would happen if it were not?

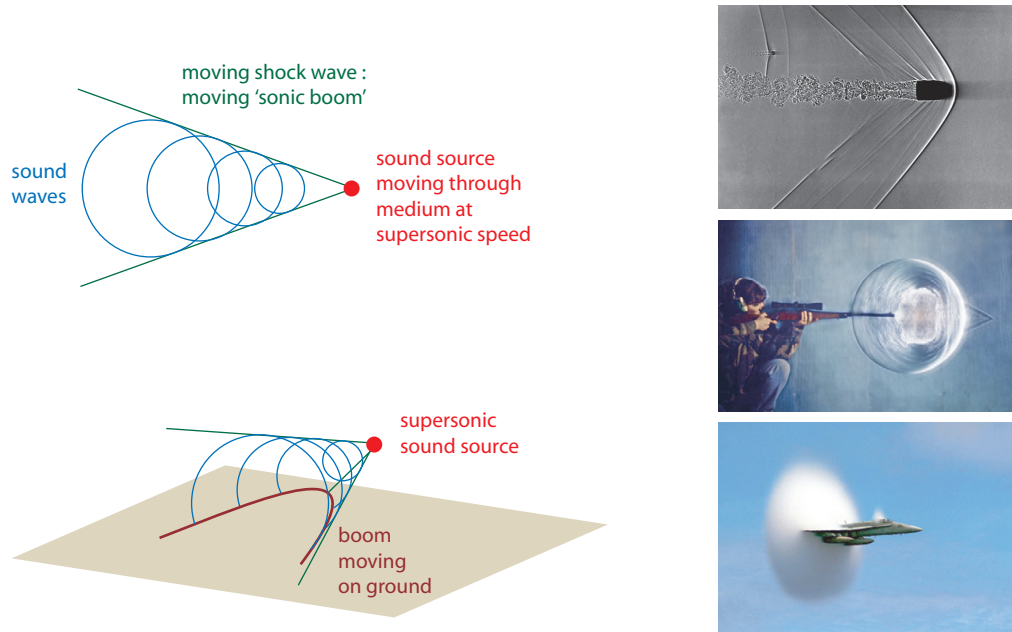
\* \*

A special type of waves appears in explosions and supersonic flight: *shock waves*. In a shock wave, the density or pressure of a gas changes abruptly, on distances of a few micrometers. Studying shock waves is a research field in itself; shock waves determine the flight of bullets, the snapping of whips and the effects of detonations.

Around a body moving with supersonic speed, the sound waves form a cone, as shown in [Figure 175](#). When the cone passes an observer on the ground, the cone leads to a *sonic boom*. What is less well known is that the boom can be amplified. If an aeroplane *accelerates* through the sound barrier, certain observers at the ground will hear two booms or even a so-called superboom, because cones from various speeds can superpose at certain spots on the ground. A plane that performs certain manoeuvres, such as a curve at high speed, can even produce a superboom at a predefined spot on the ground. In contrast to normal sonic booms, superbooms can destroy windows, eardrums and lead to trauma, especially in children. Unfortunately, they are regularly produced on purpose by

Ref. 211





**FIGURE 175** The shock wave created by a body in supersonic motion leads to a ‘sonic boom’ that moves through the air; it can be made visible by Schlieren photography or by water condensation (photo © Andrew Davidhazy, Gary Settles, NASA).

frustrated military pilots in various places of the world.

\* \*

What have swimming swans and ships have in common? The *wake* behind them. Despite the similarity, this phenomenon has no relation to the sonic boom. In fact, the angle of the wake is the *same* for ducks and ships, and is *independent* of the speed they travel or of the size of the moving body, provided the water is deep enough.

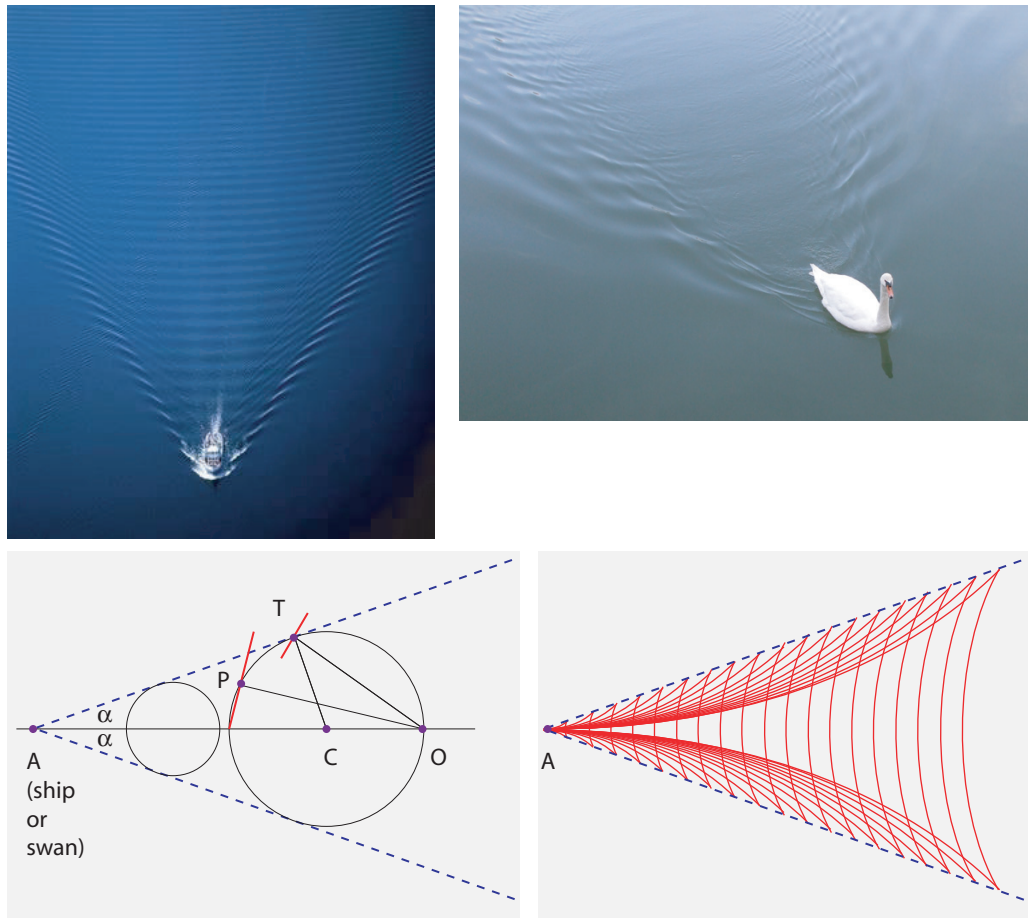
Water waves in *deep* water differ from sound waves: their group velocity is *one half* the phase velocity. (Can you deduce this from the dispersion relation  $\omega = \sqrt{gk}$  between angular frequency and wave vector, valid for deep water waves?) Water waves will interfere where most of the energy is transported, thus around the group velocity. For this reason, in the graph shown in **Figure 176**, the diameter of each wave circle is always *half* the distance of their leftmost point O to the apex A. As a result, the half angle of the wake apex obeys

$$\sin \alpha = \frac{1}{3} \quad \text{giving a wake angle} \quad 2\alpha = 38.942^\circ . \quad (101)$$

**Figure 176** also allows deducing the curves that make up the wave pattern of the wake, using simple geometry.

Ref. 212

It is essential to note that the fixed wake angle is valid only in *deep* water, i.e., only in water that is much deeper than the wavelength of the involved waves. In other words, for a given depth, the wake has the fixed shape only up to a maximum source speed. For high speeds, the wake angle narrows, and the pattern inside the wake changes.



**FIGURE 176** The wakes behind a ship and behind a swan, and the way to deduce the shape (photos © Wikimedia, Christopher Thorn).

\* \*

Bats fly at night using *echolocation*. Dolphins also use it. Sonar, used by fishing vessels to look for fish, copies the system of dolphins. Less well known is that humans have the same ability. Have you ever tried to echolocate a wall in a completely dark room? You will be surprised at how easily this is possible. Just make a loud hissing or whistling noise that stops abruptly, and listen to the echo. You will be able to locate walls reliably.

Ref. 213

Challenge 485 e

\* \*

Birds sing. If you want to explore how this happens, look at the impressive X-ray film found at the [www.indiana.edu/~songbird/multi/cineradiography\\_index.html](http://www.indiana.edu/~songbird/multi/cineradiography_index.html) website.

\* \*

Every soliton is a one-dimensional structure. Do two-dimensional analogues exist? This issue was open for many years. Finally, in 1988, Boiti, Leon, Martina and Pempinelli found that a certain evolution equation, the so-called Davey–Stewartson equation, can

Ref. 214

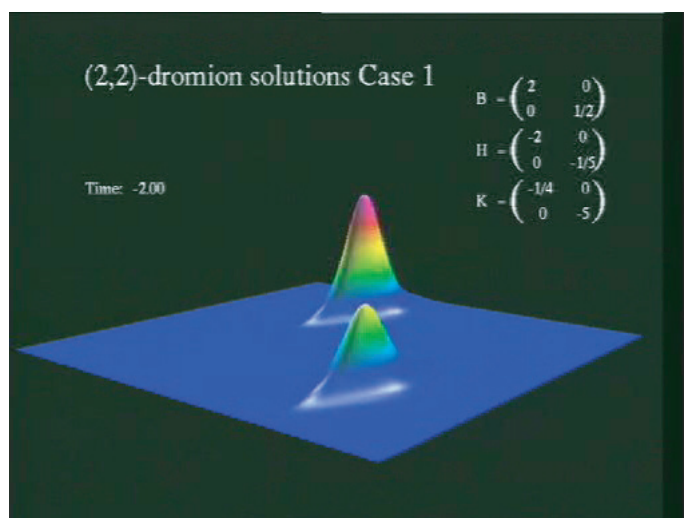


FIGURE 177 The calculated motion of a dromion across a two-dimensional substrate (QuickTime film © Jarmo Hietarinta)

have solutions that are localized in two dimensions. These results were generalized by Fokas and Santini and further generalized by Hietarinta and Hirota. Such a solution is today called a *dromion*. Dromions are bumps that are localized in two dimensions and can move, without disappearing through diffusion, in non-linear systems. An example is shown in Figure 177. However, so far, no such solution has been observed in experiments; this is one of the most important experimental challenges left open in non-linear science.

\* \*

Water waves have not lost their interest to this day. Most of all, two-dimensional solutions of solitonic water waves remain a topic of research. The mathematics is complicated, the experiments simple, and the issue is fascinating. In two dimensions, soliton crests can form hexagonal patterns! The relevant equation for shallow waves, the generalization of the Korteweg–de Vries equation to two dimensions, is called the *Kadomtsev–Petviashvili equation*. For pictures of such extremely rare waves, see the site by Bernard Deconinck at [www.amath.washington.edu/~bernard/kp/waterwaves.html](http://www.amath.washington.edu/~bernard/kp/waterwaves.html). The issue of whether rectangular patterns exist is still open, as are the equations and solutions for deep water waves. Water waves have not yet yielded all their secrets.

\* \*

How does the tone produced by blowing over a bottle depend on the dimension? For bottles that are bulky, the frequency  $f$ , the so-called *cavity resonance*, is found to depend on the volume  $V$  of the bottle:

Ref. 215

$$f = \frac{c}{2\pi} \sqrt{\frac{A}{VL}} \quad \text{or} \quad f \sim \frac{1}{\sqrt{V}} \tag{102}$$

where  $c$  is the speed of sound,  $A$  is the area of the opening, and  $L$  is the length of the

Challenge 486 e neck of the bottle. Does the formula agree with your observations?

Ref. 216 In fact, tone production is a complicated issue, and specialized books exist on the topic. For example, when overblowing, a saxophone produces a second harmonic, an octave, whereas a clarinet produces a third harmonic, a quint (more precisely, a twelfth). Why is this the case? The theory is complex, but the result simple: instruments whose cross-section increases along the tube, such as horns, trumpets, oboes or saxophones, overblow to octaves. For air instruments that have a (mostly) cylindrical tube, the effect of overblowing depends on the tone generation mechanism. Flutes overblow to the octave, but clarinets to the twelfth.

\* \*

Many acoustical systems do not only produce harmonics, but also subharmonics. There is a simple way to observe production of subharmonics: sing with your ears below water, in the bathtub. Depending on the air left in your ears, you can hear subharmonics of your own voice. The effect is quite special.

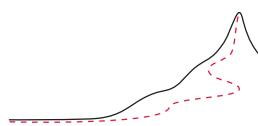
\* \*

Among the most impressive sound experiences are the singing performances of *coun-tertenors* and of the even higher singing *male sopranos*. If you ever have the chance to hear one, do not miss the occasion.

#### SUMMARY ON WAVES AND OSCILLATIONS

In nature, apart from the motion of bodies, we observe also the motion of signals, or waves. Waves have energy, momentum and angular momentum. They can interfere, diffract, refract, disperse, dampen out and, if transverse, can be polarized. Oscillations are a special case of waves.





## CHAPTER 11

# DO EXTENDED BODIES EXIST? – LIMITS OF CONTINUITY

We have just discussed the motion of extended bodies. We have seen that all extended bodies show wave motion. But are extended bodies found in nature? Strangely enough, this question has been one of the most intensely discussed questions in physics. Over the centuries, it has reappeared again and again, at each improvement of the description of motion; the answer has alternated between the affirmative and the negative. Many thinkers have been imprisoned, and many still are being persecuted, for giving answers that are not politically correct! In fact, the issue already arises in everyday life.

### MOUNTAINS AND FRACTALS

Page 51

Ref. 217

Whenever we climb a mountain, we follow the outline of its shape. We usually describe this outline as a curved two-dimensional surface. But is this correct? There are alternative possibilities. The most popular is the idea that mountains are fractal surfaces. A *fractal* was defined by Benoît Mandelbrot as a set that is self-similar under a countable but infinite number of magnification values.\* We have already encountered fractal lines. An example of an algorithm for building a (random) fractal *surface* is shown on the right side of [Figure 178](#). It produces shapes which look remarkably similar to real mountains. The results are so realistic that they are used in Hollywood films. If this description were correct, mountains would be extended, but not continuous.

Challenge 487 s

But mountains could also be fractals of a different sort, as shown in the left side of [Figure 178](#). Mountain surfaces could have an infinity of small and smaller holes. In fact, one could also imagine that mountains are described as three-dimensional versions of the left side of the figure. Mountains would then be some sort of mathematical Swiss cheese. Can you devise an experiment to decide whether fractals provide the correct description for mountains? To settle the issue, a chocolate bar can help.

### CAN A CHOCOLATE BAR LAST FOREVER?

“From a drop of water a logician could predict an Atlantic or a Niagara.”  
Arthur Conan Doyle, *A Study in Scarlet*

Any child knows how to make a chocolate bar last forever: eat half the remainder every day. However, this method only works if matter is scale-invariant. In other words, the method only works if matter is either *fractal*, as it then would be scale-invariant for a

---

\* For a definition of uncountability, see [page 198](#).

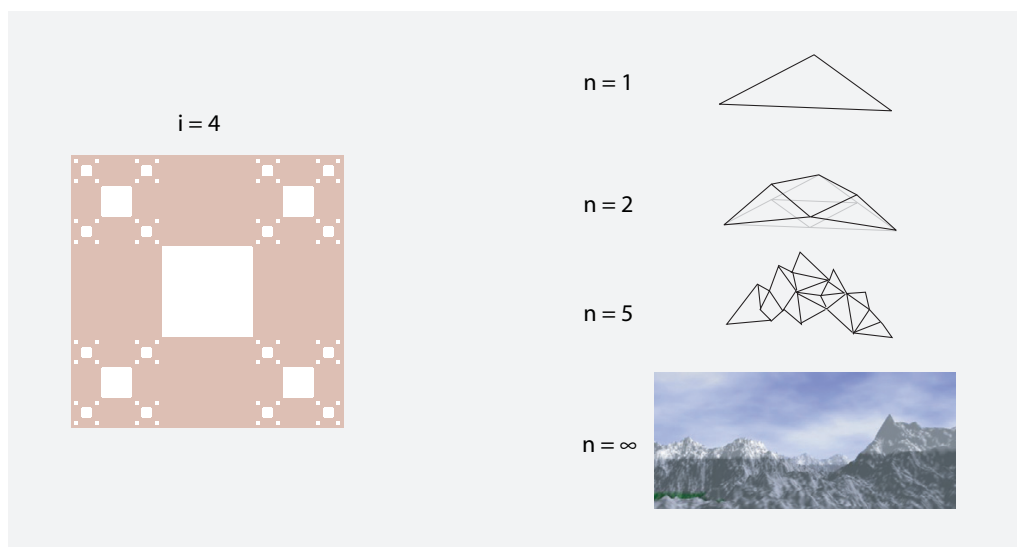


FIGURE 178 Floors (left) and mountains (right) could be fractals; for mountains this approximation is often used in computer graphics (image © Paul Martz).

discrete set of zoom factors, or *continuous*, in which case it would be scale-invariant for any zoom factor. Which case, if either, applies to nature?

Page 49

We have already encountered a fact making continuity a questionable assumption: continuity would allow us, as Banach and Tarski showed, to multiply food and any other matter by clever cutting and reassembling. Continuity would allow children to eat the *same* amount of chocolate every day, without ever buying a new bar. Matter is thus not continuous. Now, fractal chocolate is not ruled out in this way; but other experiments settle the question. Indeed, we note that melted materials do not take up much smaller volumes than solid ones. We also find that even under the highest pressures, materials do not shrink. Thus matter is not a fractal. What then is its structure?

Challenge 488 s

To get an idea of the structure of matter we can take fluid chocolate, or even just some oil – which is the main ingredient of chocolate anyway – and spread it out over a large surface. For example, we can spread a drop of oil onto a pond on a day without rain or wind; it is not difficult to observe which parts of the water are covered by the oil and which are not. A small droplet of oil cannot cover a surface larger than – can you guess the value? Trying to spread the film further inevitably rips it apart. The child's method of prolonging chocolate thus does not work for ever: it comes to a sudden end. The oil experiment, which can even be conducted at home, shows that there is a *minimum* thickness of oil films, with a value of about 2 nm. The experiment shows that there is a smallest size in oil. Oil, and all matter, is made of tiny components. This confirms the observations made by Joseph Loschmidt\* in 1865, who was the first person to measure

\* Joseph Loschmidt (b. 1821 Putschirn, d. 1895 Vienna) Austrian chemist and physicist. The oil experiment was popularized a few decades later, by Kelvin. It is often claimed that Benjamin Franklin was the first to conduct the oil experiment; that is wrong. Franklin did not measure the thickness, and did not even consider the question of the thickness. He did pour oil on water, but missed the most important conclusion that could be drawn from it. Even geniuses do not discover everything.

the size of the components of matter.

Loschmidt knew that the (dynamic) viscosity of a gas was given by  $\eta = \rho l v / 3$ , where  $\rho$  is the density of the gas,  $v$  the average speed of the components and  $l$  their mean free path. With Avogadro's prediction (made in 1811 without specifying any value) that a volume  $V$  of any gas always contains the same number  $N$  of components, one also has  $l = V / \sqrt{2\pi N \sigma^2}$ , where  $\sigma$  is the cross-section of the components. (The cross-section is roughly the area of the shadow of an object.) Loschmidt then assumed that when the gas is liquefied, the volume of the liquid is the sum of the volumes of the particles. He then measured all the involved quantities and determined  $N$ . The modern value of  $N$ , called *Avogadro's number* or *Loschmidt's number*, is  $6.02 \cdot 10^{23}$  particles in 22.4 l of any gas at standard conditions (today called 1 mol).

In 1865, it was not a surprise that matter was made of small components, as the existence of a smallest size – but not its value – had already been deduced by Galileo, when studying some other simple questions.

### THE CASE OF GALILEO GALILEI

During his life, Galileo (1564–1642) was under attack for two reasons: because of his ideas about atoms, and because of his ideas on the motion of the Earth. \* The discovery of the importance of both issues is the merit of the great historian Pietro Redondi, a collaborator of another great historian, Pierre Costabel. One of Redondi's research topics is the history of the dispute between the Jesuits, who at the time defended orthodox theology, and Galileo and the other scientists. In the 1980s, Redondi discovered a document of that time, an anonymous denunciation called G3, that allowed him to show that the condemnation of Galileo to life imprisonment for his views on the Earth's motion was organized by his friend the Pope to *protect* him from a sure condemnation to death over a different issue: atoms.

Galileo defended the view that since matter is not scale invariant, it must be made of 'atoms' or, as he called them, *piccolissimi quanti* – smallest quanta. This was and still is a heresy, because atoms of matter contradict the central Catholic idea that in the Eucharist the *sensible qualities* of bread and wine exist independently of their *substance*. The distinction between substance and sensible qualities, introduced by Thomas Aquinas, is essential to make sense of *transubstantiation*, the change of bread and wine into human flesh and blood, which is a central tenet of the Catholic faith. Indeed, a true Catholic is still not allowed to believe in atoms to the present day, because the idea that matter is made of atoms contradicts transubstantiation.

Ref. 218

In Galileo's days, church tribunals punished heresy, i.e., personal opinions deviating from orthodox theology, by the death sentence. Galileo's life was saved by the Pope by making sure that the issue of transubstantiation would not be topic of the trial, and by ensuring that the trial at the Inquisition be organized by a papal commission led by his nephew, Francesco Barberini. But the Pope also wanted Galileo to be punished, because

\* To get a clear view of the matters of dispute in the case of Galileo, especially those of interest to physicists, the best text is the excellent book by PIETRO REDONDI, *Galileo eretico*, Einaudi, 1983, translated into English as *Galileo Heretic*, Princeton University Press, 1987. It is also available in many other languages; an updated edition that includes the newest discoveries appeared in 2004.



he felt that his own ideas had been mocked in Galileo's book *Il Dialogo* and also because, under attack for his foreign policy, he was not able to ignore or suppress the issue.

As a result, in 1633 the seventy-year-old Galileo was condemned to a prison sentence, 'after invoking the name of Jesus Christ', for 'suspicion of heresy' (and thus not for heresy), because he did not comply with an earlier promise not to teach that the Earth moves. Indeed, the motion of the Earth contradicts what the Christian bible states. Galileo was convinced that *truth* was determined by observation, the Inquisition that it was determined by a book – and by itself. In many letters that Galileo wrote throughout his life he expressed his conviction that observational truth could never be a heresy. The trial showed him the opposite: he was forced to state that he erred in teaching that the Earth moves. After a while, the Pope reduced the prison sentence to house arrest.

Galileo's condemnation on the motion of the Earth was not the end of the story. In the years after Galileo's death, also atomism was condemned in several trials against Galileo's ideas and his followers. But the effects of these trials were not those planned by the Inquisition. Only twenty years after the famous trial, around 1650, every astronomer in the world was convinced of the motion of the Earth. And the result of the trials against atomism was that at the end of the 17th century, practically every scientist in the world was convinced that atoms exist. The trials accelerated an additional effect: after Galileo and Descartes, the centre of scientific research and innovation shifted from Catholic countries, like Italy or France, to protestant countries. In these, such as the Netherlands, England, Germany or the Scandinavian countries, the Inquisition had no power. This shift is still felt today.

It is a sad story that in 1992, the Catholic church did not revoke Galileo's condemnation. In that year, Pope John Paul II gave a speech on the Galileo case. Many years before, he had asked a study commission to re-evaluate the trial, because he wanted to express his regrets for what had happened and wanted to rehabilitate Galileo. The commission worked for twelve years. But the bishop that presented the final report was a crook: he avoided citing the results of the study commission, falsely stated the position of both parties on the subject of truth, falsely stated that Galileo's arguments on the motion of the Earth were weaker than those of the church, falsely summarized the past positions of the church on the motion of the Earth, avoided stating that prison sentences are not good arguments in issues of opinion or of heresy, made sure that rehabilitation was not even discussed, and of course, avoided any mention of transubstantiation. At the end of this power struggle, Galileo was thus *not* rehabilitated, in contrast to what the Pope wanted and in contrast to what most press releases of the time said; the Pope only stated that 'errors were made on both sides', and the crook behind all this was rewarded with a promotion.\*

But that is not the end of the story. The documents of the trial, which were kept locked when Redondi made his discovery, were later made accessible to scholars by Pope John Paul II. In 1999, this led to the discovery of a new document, called EE 291, an internal expert opinion the atom issue that was written for the trial in 1632, a few months before the start of the procedure. The author of the document comes to the conclusion that Galileo was indeed a heretic in the matter of atoms. The document thus proves that the cover-up

---

\* We should not be too indignant: the same situation happens in many commercial companies every day; most industrial employees can tell similar stories.

of the transubstantiation issue during the trial of Galileo must have been systematic and thorough, as Redondi had deduced. Indeed, church officials and the Catholic catechism carefully avoid the subject of atoms even today; you can search the Vatican website [www.vatican.va](http://www.vatican.va) for any mention of them.

Vol. IV, page 13 But Galileo did not want to attack transubstantiation; he wanted to advance the idea of atoms. And he did. Despite being condemned to prison in his trial, Galileo published his last book, the *Discorsi*, written as a blind old man under house arrest, on atoms. It is an irony of history that today, quantum theory, named by Max Born after the term used by Galileo for atoms, has become the most precise description of nature yet.

### HOW HIGH CAN ANIMALS JUMP?

Ref. 223 Fleas can jump to heights a hundred times their size, humans only to heights about their own size. In fact, biological studies yield a simple observation: most animals, regardless of their size, achieve about the same jumping height, namely between 0.8 and 2.2 m, whether they are humans, cats, grasshoppers, apes, horses or leopards. We have explained this fact earlier on.

Page 73

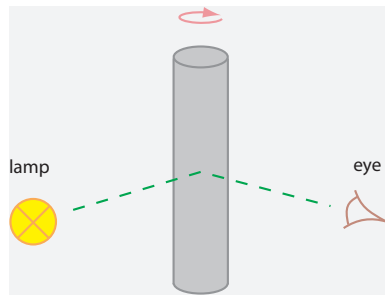
At first sight, the observation of constant jumping height seems to be a simple example of scale invariance. But let us look more closely. There are some interesting exceptions at both ends of the mass range. At the small end, mites and other small insects do not achieve such heights because, like all small objects, they encounter the problem of air resistance. At the large end, elephants do not jump that high, because doing so would break their bones. But why do bones break at all?

Why are all humans of about the same size? Why are there no giant adults with a height of ten metres? Why aren't there any land animals larger than elephants? The answer, already given by Galileo, yields the key to understanding the structure of matter. The materials of which people and animals are made would not allow such changes of scale, as the bones of giants would collapse under the weight they have to sustain. Bones have a finite strength because their constituents stick to each other with a finite attraction. Continuous matter – which exists only in cartoons – could not break at all, and fractal matter would be infinitely fragile. Matter breaks under finite loads because it is composed of small basic constituents.

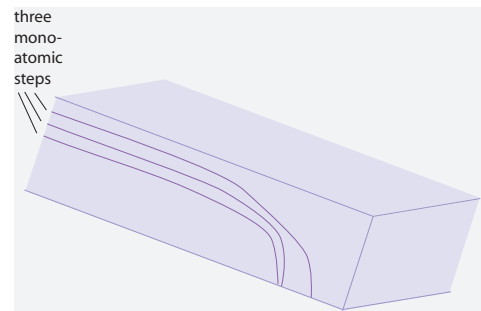
### FELLING TREES

The gentle lower slopes of Motion Mountain are covered by trees. Trees are fascinating structures. Take their size. Why do trees have limited size? Already in the sixteenth century, Galileo knew that it is not possible to increase tree height without limits: at some point a tree would not have the strength to support its own weight. He estimated the maximum height to be around 90 m; the actual record, unknown to him at the time, seems to be 150 m, for the Australian tree *Eucalyptus regnans*. But why does a limit exist at all? The answer is the same as for bones: wood has a finite strength because it is not scale invariant; and it is not scale invariant because it is made of small constituents, namely atoms.\*

Ref. 224 \* There is another important limiting factor: the water columns inside trees must not break. Both factors seem to yield similar limiting heights.



**FIGURE 179** Atoms exist: rotating an illuminated, perfectly round single crystal aluminium rod leads to brightness oscillations because of the atoms that make it up



**FIGURE 180** Atomic steps in broken gallium arsenide crystals (wafers) can be seen under a light microscope.

Challenge 489 ny

Ref. 225

Challenge 490 s

Ref. 226

Challenge 491 ny

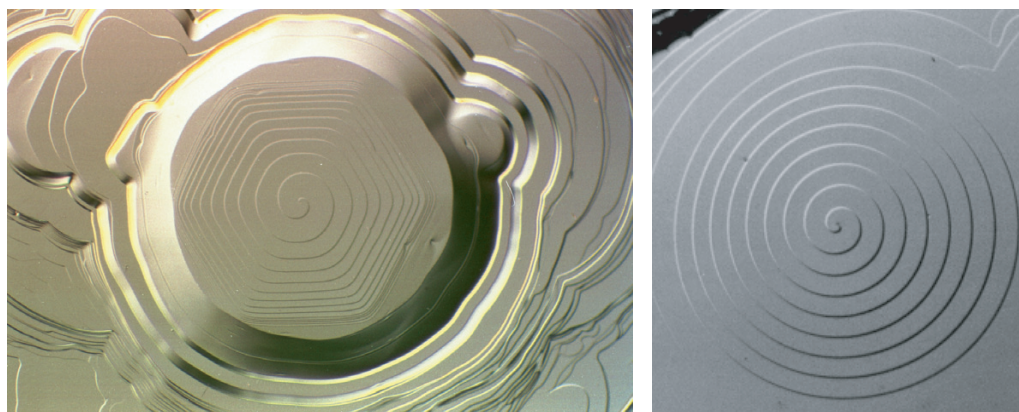
In fact, the derivation of the precise value of the height limit is more involved. Trees must not break under strong winds. Wind resistance limits the height-to-thickness ratio  $h/d$  to about 50 for normal-sized trees (for  $0.2 \text{ m} < d < 2 \text{ m}$ ). Can you say why? Thinner trees are limited in height to less than 10 m by the requirement that they return to the vertical after being bent by the wind.

Such studies of natural constraints also answer the question of why trees are made from wood and not, for example, from steel. You could check for yourself that the maximum height of a column of a given mass is determined by the ratio  $E/\rho^2$  between the elastic module and the square of the mass density. For a long time, wood was actually the material for which this ratio was highest. Only recently have material scientists managed to engineer slightly better ratios with fibre composites.

Why do materials break at all? All observations yield the same answer and confirm Galileo's reasoning: because there is a smallest size in materials. For example, bodies under stress are torn apart at the position at which their strength is minimal. If a body were completely homogeneous, it could not be torn apart; a crack could not start anywhere. If a body had a fractal Swiss-cheese structure, cracks would have places to start, but they would need only an infinitesimal shock to do so.

A simple experiment that shows that solids have a smallest size is shown in [Figure 179](#). A cylindrical rod of pure, single crystal aluminium shows a surprising behaviour when it is illuminated from the side: its brightness depends on how the rod is oriented, even though it is completely round. This angular dependence is due to the atomic arrangement of the aluminium atoms in the rod.

It is not difficult to confirm experimentally the existence of smallest size in solids. It is sufficient to break a single crystal, such as a gallium arsenide wafer, in two. The breaking surface is either completely flat or shows extremely small steps, as shown in [Figure 180](#). These steps are visible under a normal light microscope. (Why?) It turns out that all the step heights are multiples of a smallest height: its value is about 0.2 nm. The existence of a smallest height, corresponding to the height of an atom, contradicts all possibilities of scale invariance in matter.



**FIGURE 181** An effect of atoms: steps on single crystal surfaces – here silicon carbide grown on a carbon-terminated substrate (left) and on a silicon terminated substrate (right) (© Dietmar Siche).

### THE SOUND OF SILENCE

Climbing the slopes of Motion Mountain, we arrive in a region of the forest covered with deep snow. We stop for a minute and look around. It is dark; all the animals are asleep; there is no wind and there are no sources of sound. We stand still, without breathing, and listen to the silence. (You can have this experience also in a sound studio such as those used for musical recordings, or in a quiet bedroom at night.) In situations of complete silence, the ear automatically becomes more sensitive<sup>\*</sup>; we then have a strange experience. We hear two noises, a lower- and a higher-pitched one, which are obviously generated inside the ear. Experiments show that the higher note is due to the activity of the nerve cells in the inner ear. The lower note is due to pulsating blood streaming through the head. But why do we hear a noise at all?

Many similar experiments confirm that whatever we do, we can never eliminate noise from measurements. This unavoidable type of noise is called *shot noise* in physics. The statistical properties of this type of noise actually correspond precisely to what would be expected if flows, instead of being motions of continuous matter, were transportation of a large number of equal, small and discrete entities. Thus, simply listening to noise proves that electric current is made of electrons, that air and liquids are made of molecules, and that light is made of photons. In a sense, the sound of silence is the sound of atoms. Shot noise would not exist in continuous systems.

### LITTLE HARD BALLS

“ I prefer knowing the cause of a single thing to being king of Persia. ”  
Democritus

Precise observations show that matter is neither continuous nor a fractal: matter is made of smallest basic particles. Galileo, who deduced their existence by thinking about giants and trees, called them ‘smallest quanta.’ Today they are called ‘atoms’, in honour of

<sup>\*</sup> The human ear can detect pressure variations at least as small as 20  $\mu\text{Pa}$ .

TABLE 40 Some measured pressure values.

OBSERVATION	PRESSURE
Record negative pressure (tension) measured in water, after careful purification Ref. 227	−140 MPa = −1400 bar
Negative pressure measured in tree sap (xylem) Ref. 228, Ref. 225	up to −10 MPa = −100 bar
Negative pressure in gases	does not exist
Negative pressure in solids	is called tension
Record vacuum pressure achieved in laboratory	10 pPa ( $10^{-13}$ torr)
Pressure variation at hearing threshold	20 $\mu$ Pa
Pressure variation at hearing pain	100 Pa
Atmospheric pressure in La Paz, Bolivia	51 kPa
Atmospheric pressure in cruising passenger aircraft	75 kPa
Time-averaged pressure in pleural cavity in human thorax	0.5 kPa below atmospheric pressure
Standard sea-level atmospheric pressure	101.325 kPa or 1013.25 mbar or 760 torr
Healthy human arterial blood pressure at height of the heart: systolic, diastolic	17 kPa, 11 kPa above atmospheric pressure
Record pressure produced in laboratory, using a diamond anvil	c. 200 GPa
Pressure at the centre of the Earth	c. 370(20) GPa
Pressure at the centre of the Sun	c. 24 PPa
Pressure at the centre of a neutron star	c. $4 \cdot 10^{33}$ Pa
Planck pressure (maximum pressure possible in nature)	$4.6 \cdot 10^{113}$ Pa

a famous argument of the ancient Greeks. Indeed, 2500 years ago, the Greeks asked the following question. If motion and matter are conserved, how can change and transformation exist? The philosophical school of Leucippus and Democritus of Abdera\* studied

\* Leucippus of Elea (Λευκιππος) (c. 490 to c. 430 BCE), Greek philosopher; Elea was a small town south of Naples. It lies in Italy, but used to belong to the Magna Graecia. Democritus (Δεμοκρίτος) of Abdera (c. 460 to c. 356 or 370 BCE), also a Greek philosopher, was arguably the greatest philosopher who ever lived. Together with his teacher Leucippus, he was the founder of the atomic theory; Democritus was a much admired thinker, and a contemporary of Socrates. The vain Plato never even mentions him, as Democritus was a danger to his own fame. Democritus wrote many books which all have been lost; they were not copied

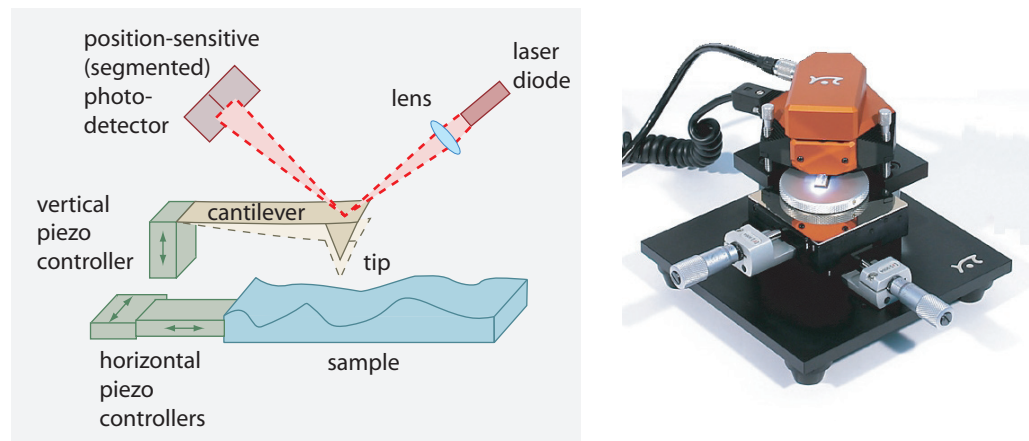


FIGURE 182 The principle and a realization of an atomic force microscope (photograph © Nanosurf).

two particular observations in special detail. They noted that salt dissolves in water. They also noted that fish can swim in water. In the first case, the volume of water does not increase when the salt is dissolved. In the second case, when fish advance, they must push water aside. Leucippus and Democritus deduced that there is only one possible explanation that satisfies observations and also reconciles conservation and transformation: nature is made of void and of small, indivisible and conserved particles.\* In this way any example of motion, change or transformation is due to rearrangements of these particles; change and conservation are thus reconciled.

In short, since matter is hard, has a shape and is divisible, Leucippus and Democritus imagined it as being made of atoms. Atoms are particles which are hard, have a shape, but are indivisible. In other words, the Greeks imagined nature as a big Lego set. Lego pieces are first of all hard or *impenetrable*, i.e., repulsive at very small distances. They are *attractive* at small distances: they remain stuck together. Finally, they have *no interaction* at large distances. Atoms behave in the same way. (Actually, what the Greeks called 'atoms' partly corresponds to what today we call 'molecules'. The latter term was invented by Amadeo Avogadro in 1811 in order to clarify the distinction. But we can forget this detail for the moment.)

Since atoms are invisible, it took many years before all scientists were convinced by

---

during the Middle Ages because of his scientific and rational world view, which was felt to be a danger by religious zealots who had the monopoly on the copying industry. Nowadays, it has become common to claim – incorrectly – that Democritus had no proof for the existence of atoms. That is a typical example of disinformation with the aim of making us feel superior to the ancients.

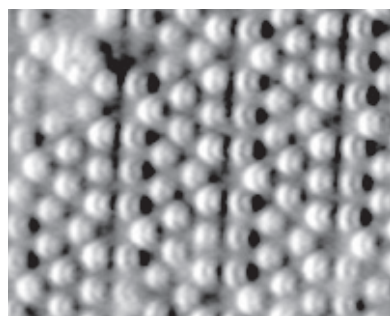
\* The story is told by Lucretius, in full Titus Lucretius Carus, in his famous text *De rerum natura*, around 60 B.C.E. (An English translation can be found on [perseus.uchicago.edu/hopper/text.jsp?doc=Perseus:text:1999.02.0131](http://perseus.uchicago.edu/hopper/text.jsp?doc=Perseus:text:1999.02.0131).) Lucretius relates many other proofs; in Book 1, he shows that there is vacuum in solids – as proven by porosity and by density differences – and in gases – as proven by wind. He shows that smells are due to particles, and that so is evaporation. (Can you find more proofs?) He also explains that the particles cannot be seen due to their small size, but that their effects can be felt and that they allow explaining all observations consistently.

Especially if we imagine particles as little balls, we cannot avoid calling this a typically male idea. (What would be the female approach?)

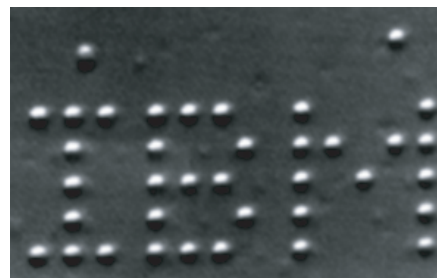
Challenge 492 ny

Challenge 493 d





**FIGURE 183** The atoms on the surface of a silicon crystal, mapped with an atomic force microscope (© Universität Augsburg)



**FIGURE 184** The result of moving helium atoms on a metallic surface (© IBM).

the experiments showing their existence. In the nineteenth century, the idea of atoms was beautifully verified by the discovery of the ‘laws’ of chemistry and those of gas behaviour. Later on, the noise effects were discovered.

Page 301

Ref. 229, Ref. 230

Ref. 231

Nowadays, with advances in technology, single atoms can be seen, photographed, hologrammed, counted, touched, moved, lifted, levitated, and thrown around. And indeed, like everyday matter, atoms have mass, size, shape and colour. Single atoms have even been used as lamps and lasers.

Ref. 232

Ref. 233

Modern researchers in several fields have fun playing with atoms in the same way that children play with Lego. Maybe the most beautiful demonstration of these possibilities is provided by the many applications of the atomic force microscope. If you ever have the opportunity to use one, do not miss it! An atomic force microscope is a simple tabletop device which follows the surface of an object with an atomically sharp needle;\* such needles, usually of tungsten, are easily manufactured with a simple etching method. The changes in the height of the needle along its path over the surface are recorded with the help of a deflected light ray. With a little care, the atoms of the object can be felt and made visible on a computer screen. With special types of such microscopes, the needle can be used to move atoms one by one to specified places on the surface. It is also possible to scan a surface, pick up a given atom and throw it towards a mass spectrometer to determine what sort of atom it is.

Ref. 234

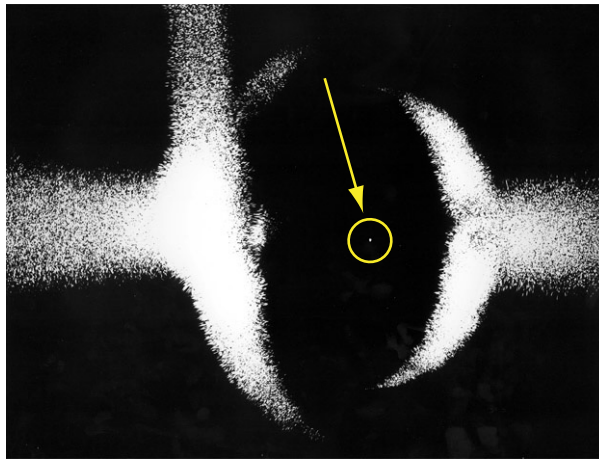
Incidentally, the construction of atomic force microscopes is only a small improvement on what nature is building already by the millions; when we use our ears to listen, we are actually detecting changes in eardrum position of about 1 nm. In other words, we all have two ‘atomic force microscopes’ built into our heads.

In summary, matter is not scale invariant: in particular, it is neither smooth nor fractal. Matter is made of atoms. Different types of atoms, as well as their various combinations, produce different types of substances. Pictures from atomic force microscopes show that the size and arrangement of atoms produce the *shape* and the *extension* of objects, confirming the Lego model of matter.\*\* As a result, the description of the motion of extended

\* A cheap version costs only a few thousand euro, and will allow you to study the difference between a silicon wafer – crystalline – a flour wafer – granular-amorphous – and a consecrated wafer.

\*\* Studying matter in even more detail yields the now well-known idea that matter, at higher and higher





**FIGURE 185** A single barium ion levitated in a Paul trap (image size around 2 mm) at the centre of the picture, visible also to the naked eye in the original experiment, performed in 1985 (© Werner Neuhauser).

objects can be reduced to the description of the motion of their atoms. Atomic motion will be a major theme in the following pages. One of its consequences is especially important: heat. Before we study it, we have a look at fluids.

### THE MOTION OF FLUIDS

Ref. 235  
Page 318

Fluids can be liquids or gases. Their motion can be exceedingly complex, as [Figure 186](#) shows. Such complex motions are often examples of self-organization or chaos; an introduction into such effects is given below.

Like all motion, fluid motion obeys energy conservation. In the case that no energy is transformed into heat, the conservation of energy is particularly simple. Motion that does not generate heat implies the lack of vortices; such fluid motion is called *laminar*. If the speed of the fluid does not depend on time at all positions, it is called *stationary*. For motion that is both laminar and stationary, energy conservation can be expressed with speed  $v$  and pressure  $p$ :

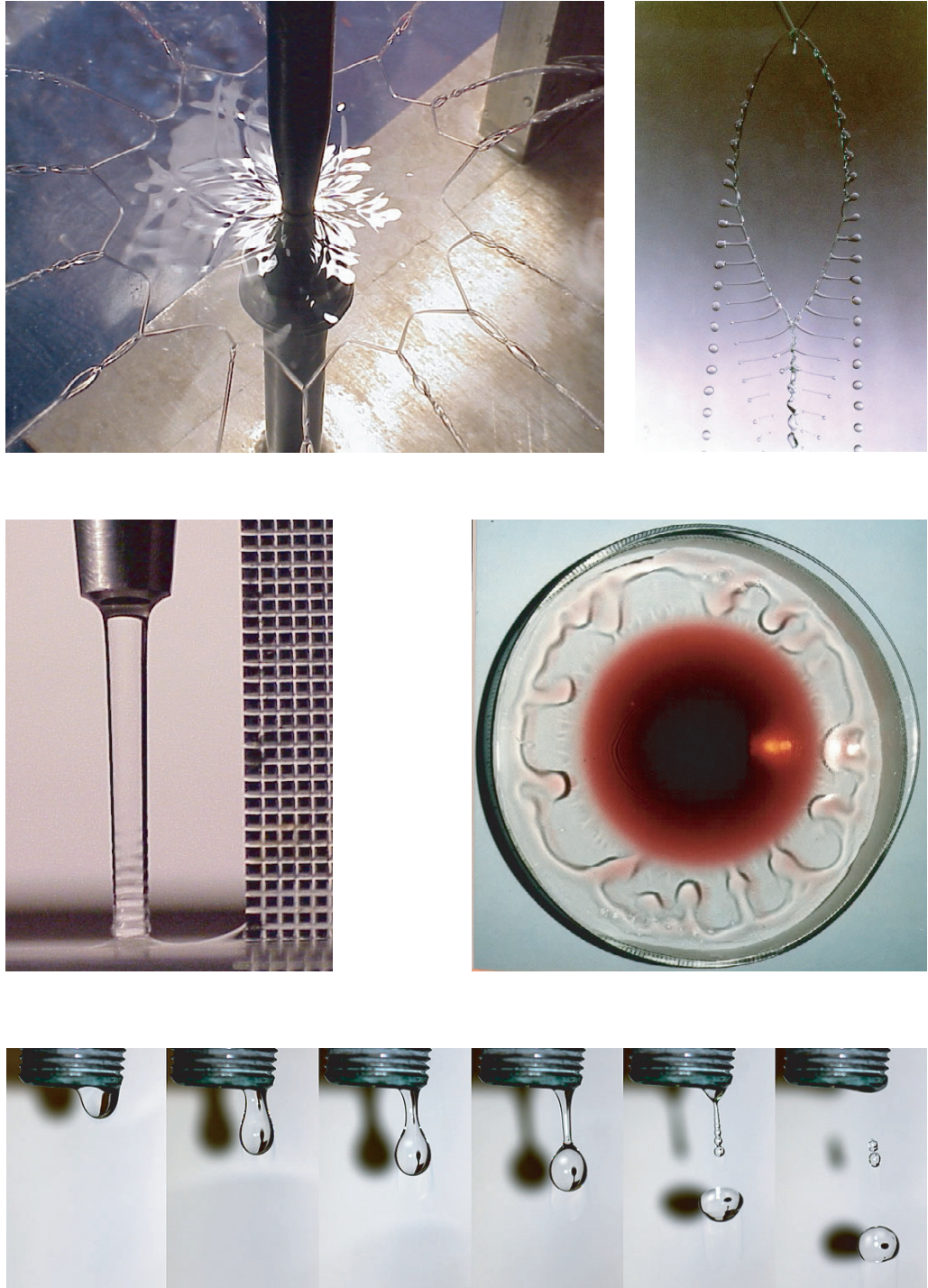
$$\frac{1}{2}\rho v^2 + p + \rho gh = \text{const} \quad (103)$$

where  $h$  is the height above ground. This is called *Bernoulli's equation*.<sup>\*</sup> In this equation,

magnifications, is made of molecules, atoms, nuclei, protons and neutrons, and finally, quarks. Atoms also contain electrons. A final type of matter, neutrinos, is observed coming from the Sun and from certain types of radioactive materials. Even though the fundamental bricks have become smaller with time, the basic idea remains: matter is made of smallest entities, nowadays called elementary particles. In the parts on quantum theory of our mountain ascent we will explore this idea in detail.

<sup>\*</sup> Daniel Bernoulli (b. 1700 Bâle, d. 1782 Bâle), important Swiss mathematician and physicist. His father Johann and his uncle Jakob were famous mathematicians, as were his brothers and some of his nephews. Daniel Bernoulli published many mathematical and physical results. In physics, he studied the separation of compound motion into translation and rotation. In 1738 he published the *Hydrodynamique*, in which he deduced all results from a single principle, namely the conservation of energy. The so-called *Bernoulli equation* states that (and how) the pressure of a fluid decreases when its speed increases. He studied the tides and many complex mechanical problems, and explained the Boyle–Mariotte gas ‘law’. For his publications he won the prestigious prize of the French Academy of Sciences – a forerunner of the Nobel Prize – ten

Vol. V, page 190



**FIGURE 186** Examples of fluid motion: a vertical water jet striking a horizontal impactor, two jets of a glycerol–water mixture colliding at an oblique angle, a water jet impinging on a reservoir, a glass of wine showing tears (all © John Bush, MIT) and a dripping water tap (© Andrew Davidhazy).



FIGURE 187 Daniel Bernoulli (1700–1782)

the first term is the kinetic energy (per volume) of the fluid, and the other two terms are potential energies (per volume). Indeed, the second term is the potential energy (per volume) resulting from the compression of the fluid. Indeed, pressure is a potential energy per volume. The last term is only important if the fluid rises against ground.

Challenge 494 e

Energy conservation implies that the lower the pressure is, the larger the speed of a fluid becomes. One can use this relation to measure the speed of a stationary water flow in a tube. One just has to narrow the tube somewhat at one location along the tube, and measure the pressure difference before and at the tube restriction. One finds that the speed  $v$  far from the constriction is given as  $v = k\sqrt{p_1 - p_2}$ . (What is the constant  $k$ ?) A device using this method is called a Venturi gauge.

Challenge 495 s

If the geometry of a system is kept fixed and the fluid speed is increased, at a certain speed one observes a transition: the liquid loses its clarity, the flow is not stationary any more. This is seen whenever a water tap is opened. The flow has changed from laminar to turbulent. At this point, Bernoulli's equation is not valid any more.

The description of turbulence might be the toughest of all problems in physics. When the young Werner Heisenberg was asked to continue research on turbulence, he refused – rightly so – saying it was too difficult; he turned to something easier and discovered and developed quantum mechanics instead. Turbulence is such a vast topic, with many of its concepts still not settled, that despite the number and importance of its applications, only now, at the beginning of the twenty-first century, are its secrets beginning to be unravelled. It is thought that the equations of motion describing fluids, the so-called *Navier–Stokes equations*, are sufficient to understand turbulence.\* But the mathematics behind them is mind-boggling. There is even a prize of one million dollars offered by the Clay Mathematics Institute for the completion of certain steps on the way to solving the equations.

Ref. 236

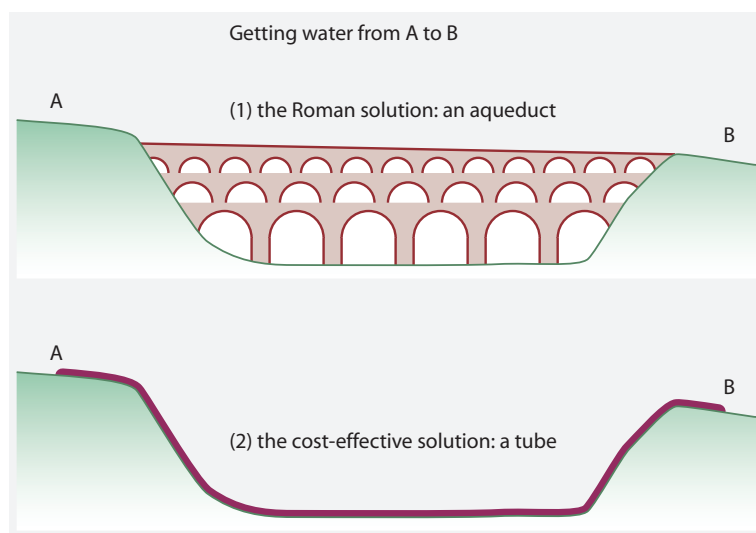
Important systems which show laminar flow, vortices and turbulence at the same time are wings and sails. (See Figure 188.) All wings work best in laminar mode. The essence of a wing is that it imparts air a downward velocity with as little turbulence as possible. (The aim to minimize turbulence is the reason that wings are curved. If the engine is very powerful, a flat wing at an angle also works. Strong turbulence is also of advantage

times.

\* They are named after Claude Navier (b. 1785 Dijon, d. 1836 Paris), important French engineer and bridge builder, and Georges Gabriel Stokes (b. 1819 Skreen, d. 1903 Cambridge), important Irish physicist and mathematician.



**FIGURE 188** The *moth* sailing class: a 30 kg boat that sails above the water using *hydrofoils*, i.e., underwater wings (© Bladerider International).



**FIGURE 189** Wasting money because of lack of knowledge about fluids.

Ref. 237

for landing safely.) The downward velocity of the trailing air leads to a centrifugal force acting on the air that passes above the wing. This leads to a lower pressure, and thus to lift. (Wings thus do *not* rely on the Bernoulli equation, where lower pressure *along* the flow leads to higher air speed, as unfortunately, many books used to say. Above a wing, the higher speed is related to lower pressure *across* the flow.)

Vol. V, page 203

The different speeds of the air above and below the wing lead to vortices at the end of every wing. These vortices are especially important for the take-off of any insect, bird and aeroplane. More details on wings are discussed later on.

#### CURIOSITIES AND FUN CHALLENGES ABOUT FLUIDS

What happens if people do not know the rules of nature? The answer is the same since 2000 years ago: taxpayer's money is wasted or health is in danger. One of the oldest ex-



amples, the aqueducts from Roman time, is shown in [Figure 189](#). They only exist because Romans did not know how fluids move. Now you know why there are no aqueducts any more. But using a 1 or 2 m water hose in this way to transport gasoline can be dangerous. Why?

Challenge 496 s

\* \*

You bathtub is full of water. You have an unmarked 3-litre container and an unmarked 5-litre container. How can you get 4 litres of water from the bathtub?

Challenge 497 e

\* \*

The physics of under water diving, in particular of apnoea diving, is full of wonders and of effects that are not yet understood. For example, every apnoea champion known that it is quite hard to hold the breath for five or six minutes while sitting in a chair. But if the same is done in a swimming pool, the feat becomes readily achievable for modern apnoea champions. (It is not really clear why this is the case.) There are many apnoea diving disciplines. In 2009, the no-limit diving record is at the incredible depth of 214 m, achieved by Herbert Nitsch.

Ref. 238

When an apnoea diver reaches a depth of 100 m, the water pressure corresponds to a weight of over 11 kg on each square centimetre of his skin. To avoid the problems of ear pressure compensation at great depths, he has flooded the mouth and the trachea with water. His lungs have shrunk to one eleventh of their original size, to the size of apples. The water pressure shifts almost all blood from the legs and arms into the thorax and the brain. At 150 m, there is no light, and no sound – only the heart beat. And the heart beat is slow: there is only a beat every seven or eight seconds. He becomes relaxed and euphoric at the same time. None of these fascinating observations is fully understood.

\* \*

What is the speed record for motion under water? Probably nobody knows: it is a military secret. In fact, the answer needs to be split. The fastest published speed for a projectile under water, almost fully enclosed in a gas bubble, is 1550 m/s, faster than the speed of sound in water, achieved over a distance of a few metres in a military laboratory in the 1990s. The fastest system with an engine seems to be a torpedo, also moving mainly in a gas bubble, that reaches over 120 m/s, thus faster than any formula 1 racing car. The exact speed achieved is higher and secret. (The method of enclosing objects under water in gas bubbles, called *supercavitation*, is a research topic of military engineers all over the world.) The fastest fish, the sailfish *Istiophorus platypterus*, reaches 22 m/s, but speeds up to 30 m are suspected. The fastest manned objects are military submarines, whose speeds are secret, but believed to be around 21 m/s. (All military naval engineers in this world, with the enormous budgets they have, are not able to make submarines that are faster than fish. The reason that aeroplanes are faster than birds is evident: aeroplanes were not developed by military engineers.) The fastest human-powered submarines reach around 4 m/s. One can guess that if human-powered submarine developers had the same development budget as military engineers, their machines would probably be faster than nuclear submarines.

There are no record lists for swimming under water. Underwater swimming is known to be faster than above-water breast stroke, back stroke or dolphin stroke: that is the

reason that swimming underwater over long distances is forbidden in competitions in these styles. However, it is not known whether crawl-style records are faster or slower than records for the fastest swimming style below water. Which one is faster in your own case?

Challenge 498 e

\* \*

How much water is necessary to moisten the air in a room in winter? At  $0^{\circ}\text{C}$ , the vapour pressure of water is 6 mbar,  $20^{\circ}\text{C}$  it is 23 mbar. As a result, heating air in the winter gives at most a humidity of 25%. To increase the humidity by 50%, one thus needs about 1 litre of water per  $100\text{ m}^3$ .

Challenge 499 e

\* \*

Fluid motion is of vital importance. There are at least four fluid circulation systems inside the human body. First, *air* is circulated inside the lungs by the diaphragm and other chest muscles. Second, *blood* flows through the blood system by the heart. Third, *lymph* flows through the lymphatic vessels, moved passively by body muscles. Fourth, the *cerebrospinal fluid* circulates around the brain and the spine, moved by motions of the head. For this reason, medical doctors like the simple statement: every illness is ultimately due to bad circulation.

Why do animals have blood and other circulation systems? Because fluid diffusion is too slow. Can you detail the argument?

Challenge 500 e

\* \*

All animals have similar blood circulation speeds, namely between 0.2 m/s and 0.4 m/s. Why?

Challenge 501 ny

\* \*

Liquid pressure depends on height. If the average human blood pressure at the height of the heart is 13.3 kPa, can you guess what it is inside the feet when standing?

Challenge 502 s

\* \*

The human heart pumps blood at a rate of about 0.1 l/s. A typical capillary has the diameter of a red blood cell, around  $7\ \mu\text{m}$ , and in it the blood moves at a speed of half a millimetre per second. How many capillaries are there in a human?

Challenge 503 s

\* \*

You are in a boat on a pond with a stone, a bucket of water and a piece of wood. What happens to the water level of the pond after you throw the stone in it? After you throw the water into the pond? After you throw the piece of wood?

Challenge 504 s

\* \*

A ship leaves a river and enter the sea. What happens?

Challenge 505 s

\* \*

Put a rubber air balloon over the end of a bottle and let it hang inside the bottle. How

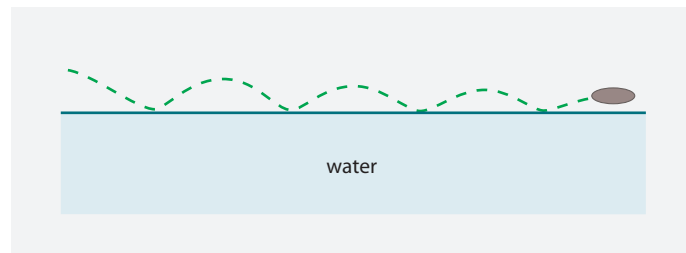


FIGURE 190 What is your personal stone-skipping record?

Challenge 506 e much can you blow up the balloon inside the bottle?

\* \*

Challenge 507 e Put a small paper ball into the neck of a horizontal bottle and try to blow it into the bottle. The paper will fly *towards* you. Why?

\* \*

Challenge 508 e It is possible to blow an egg from one egg-cup to a second one just behind it. Can you perform this trick?

\* \*

Challenge 509 s In the seventeenth century, engineers who needed to pump water faced a challenge. To pump water from mine shafts to the surface, no water pump managed more than 10 m of height difference. For twice that height, one always needed two pumps in series, connected by an intermediate reservoir. Why? How then do trees manage to pump water upwards for larger heights?

\* \*

Challenge 510 s When hydrogen and oxygen are combined to form water, the amount of hydrogen needed is exactly twice the amount of oxygen, if no gas is to be left over after the reaction. How does this observation confirm the existence of atoms?

\* \*

Challenge 511 s How are alcohol-filled chocolate pralines made? Note that the alcohol is not injected into them afterwards, because there would be no way to keep the result tight enough.

\* \*

Ref. 239 How often can a stone jump when it is thrown over the surface of water? The present world record was achieved in 2002: 40 jumps. More information is known about the previous world record, achieved in 1992: a palm-sized, triangular and flat stone was thrown with a speed of 12 m/s (others say 20 m/s) and a rotation speed of about 14 revolutions per second along a river, covering about 100 m with 38 jumps. (The sequence was filmed with a video recorder from a bridge.)

Challenge 512 r What would be necessary to increase the number of jumps? Can you build a machine that is a better thrower than yourself?



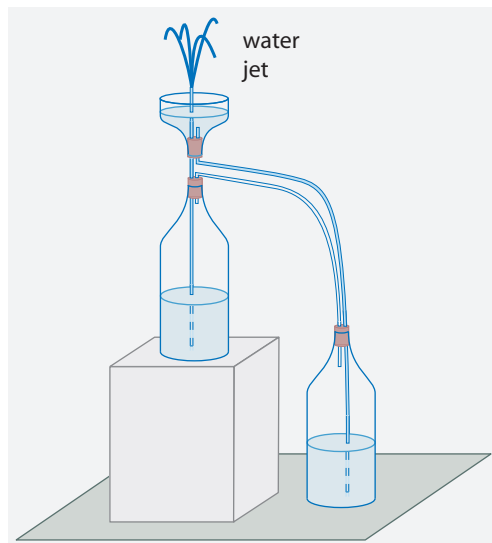


FIGURE 191 Heron's fountain.

\* \*

**Challenge 513 s** The most important component of air is nitrogen (about 78 %). The second component is oxygen (about 21 %). What is the third one?

\* \*

**Challenge 514 s** Which everyday system has a pressure lower than that of the atmosphere and usually kills a person if the pressure is raised to the usual atmospheric value?

\* \*

**Challenge 515 s** Water can flow uphill: Heron's fountain shows this most clearly. Heron of Alexandria (c. 10 to c. 70) described it 2000 years ago; it is easily built at home, using some plastic bottles and a little tubing. How does it work?

\* \*

**Challenge 516 s** A light bulb is placed, underwater, in a stable steel cylinder with a diameter of 16 cm. A Fiat Cinquecento car (500 kg) is placed on a piston pushing onto the water surface. Will the bulb resist?

\* \*

**Challenge 517 s** What is the most dense gas? The most dense vapour?

\* \*

**Challenge 518 e** Every year, the Institute of Maritime Systems of the University of Rostock organizes a contest. The challenge is to build a paper boat with the highest carrying capacity. The paper boat must weigh at most 10 g and fulfil a few additional conditions; the carrying capacity is measured by pouring lead small shot onto it, until the boat sinks. The 2008 record stands at 5.1 kg. Can you achieve this value? (For more information, see the [www](http://www).

[paperboat.de](http://paperboat.de) website.)

\* \*

Challenge 519 s A modern version of an old question – already posed by Daniel Colladon (1802–1893) – is the following. A ship of mass  $m$  in a river is pulled by horses walking along the river bank attached by ropes. If the river is of superfluid helium, meaning that there is no friction between ship and river, what energy is necessary to pull the ship upstream along the river until a height  $h$  has been gained?

\* \*

Challenge 520 e An urban legend pretends that at the bottom of large waterfalls there is not enough air to breathe. Why is this wrong?

\* \*

Challenge 521 s The Swiss physicist and inventor Auguste Piccard (1884–1962) was a famous explorer. Among others, he explored the stratosphere: he reached the record height of 16 km in his *aerostat*, a hydrogen gas balloon. Inside the airtight cabin hanging under his balloon, he had normal air pressure. However, he needed to introduce several ropes attached at the balloon into the cabin, in order to be able to pull and release them, as they controlled his balloon. How did he get the ropes into the cabin while at the same time preventing air from leaving?

\* \*

Challenge 522 s A human cannot breathe at any depth under water, even if he has a tube going to the surface. At a few metres of depth, trying to do so is inevitably fatal! Even at a depth of 60 cm only, the human body can only breathe in this way for a few minutes. Why?

\* \*

Challenge 523 ny A human in air falls with a limiting speed of about 50 m/s (the precise value depends on clothing). How long does it take to fall from a plane at 3000 m down to a height of 200 m?

\* \*

Challenge 524 s To get an idea of the size of Avogadro's and Loschmidt's number, two questions are usually asked. First, on average, how many molecules or atoms that you breathe in with every breath have previously been exhaled by Caesar? Second, on average, how many atoms of Jesus do you eat every day? Even though the Earth is large, the resulting numbers are still telling.

\* \*

Ref. 240 A few drops of tea usually flow along the underside of the spout of a teapot (or fall onto the table). This phenomenon has even been simulated using supercomputer simulations of the motion of liquids, by Kistler and Scriven, using the Navier–Stokes equations. Teapots are still shedding drops, though.

\* \*

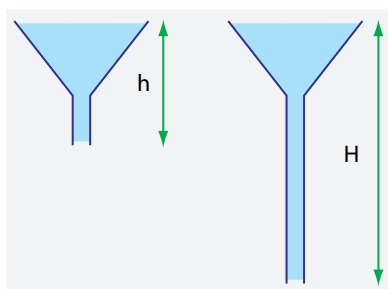


FIGURE 192 Which funnel is faster?

The best giant soap bubbles can be made by mixing 1.5 l of water, 200 ml of corn syrup and 450 ml of washing-up liquid. Mix everything together and then let it rest for four hours. You can then make the largest bubbles by dipping a metal ring of up to 100 mm diameter into the mixture. But why do soap bubbles burst?

Challenge 525 s

\* \*

A drop of water that falls into a pan containing hot oil dances on the surface for a considerable time, if the oil is above  $220^{\circ}\text{C}$ . Cooks test the temperature of oil in this way. Why does this so-called *Leidenfrost effect*\* take place? The Leidenfrost effect allows one to plunge the bare hand into molten lead, to keep liquid nitrogen in one's mouth, to check whether a pressing iron is hot, or to walk over hot coal – if one follows several safety rules, as explained by Jearl Walker. (Do *not* try this yourself! Many things can go wrong.) The main condition is that the hand, the mouth or the feet must be wet. Walker lost two teeth in a demonstration and badly burned his feet in a walk when the condition was not met.

Challenge 526 s

Ref. 241

\* \*

Challenge 527 s Why don't air molecules fall towards the bottom of the container and stay there?

\* \*

Challenge 528 s Which of the two water funnels in Figure 192 is emptied more rapidly? Apply energy conservation to the fluid's motion (the Bernoulli equation) to find the answer.

Ref. 242

\* \*

Challenge 529 s As we have seen, fast flow generates an underpressure. How do fish prevent their eyes from popping when they swim rapidly?

\* \*

Challenge 530 ny

Golf balls have dimples for the same reasons that tennis balls are hairy and that shark and dolphin skin is not flat: deviations from flatness reduce the flow resistance because many small eddies produce less friction than a few large ones. Why?

\* \*

The recognized record height reached by a helicopter is 12 442 m above sea level, though

---

\* It is named after Johann Gottlieb Leidenfrost (1715–1794), German physician.

12 954 m has also been claimed. (The first height was reached in 1972, the second in 2002, both by French pilots in French helicopters.) Why, then, do people still continue to use their legs in order to reach the top of Mount Sagarmatha, the highest mountain in the world?

Challenge 531 s

\* \*

A loosely knotted sewing thread lies on the surface of a bowl filled with water. Putting a bit of washing-up liquid into the area surrounded by the thread makes it immediately become circular. Why?

Challenge 532 e

\* \*

Challenge 533 s How can you put a handkerchief under water using a glass, while keeping it dry?

\* \*

Are you able to blow a ping-pong ball out of a funnel? What happens if you blow through a funnel towards a burning candle?

\* \*

The fall of a leaf, with its complex path, is still a topic of investigation. We are far from being able to predict the time a leaf will take to reach the ground; the motion of the air around a leaf is not easy to describe. One of the simplest phenomena of hydrodynamics remains one of its most difficult problems.

\* \*

Ref. 243

Fluids exhibit many interesting effects. Soap bubbles in air are made of a thin spherical film of liquid with air on both sides. In 1932, anti-bubbles, thin spherical films of air with liquid on both sides, were first observed. In 2004, the Belgian physicist Stéphane Dorbolo and his team showed that it is possible to produce them in simple experiments, and in particular, in Belgian beer.

\* \*

Challenge 534 e

Have you ever dropped a Mentos candy into a Diet Coca Cola bottle? You will get an interesting effect. (Do it at your own risk...) Is it possible to build a rocket in this way?

\* \*

Challenge 535 e

A needle can swim on water, if you put it there carefully. Just try, using a fork. Why does it float?

\* \*

Challenge 536 e

The Rhine emits about  $2\,300\text{ m}^3/\text{s}$  of water into the North Sea, the Amazon River about  $120\,000\text{ m}^3/\text{s}$  into the Atlantic. How much is this less than  $c^3/4G$ ?

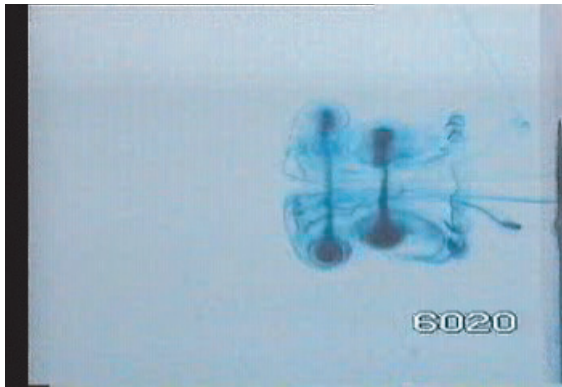
\* \*

Challenge 537 e

Fluids exhibit many complex motions. To see an overview, have a look at the beautiful collection on the web site [serve.me.nus.edu.sg/limtt](http://serve.me.nus.edu.sg/limtt). Among fluid motion, vortex rings, as emitted by smokers or volcanoes, have often triggered the imagination. (See [Figure 193](#).)



**FIGURE 193** A smoke ring, around 100 m in size, ejected from Etna's Bocca Nova in 2000 (© Daniela Szczepanski at [www.vulkanarchiv.de](http://www.vulkanarchiv.de) and [www.vulkane.net](http://www.vulkane.net)).



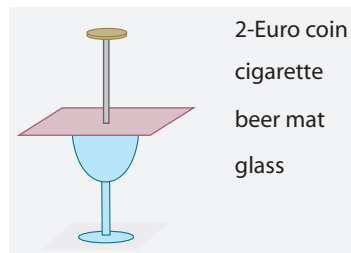
**FIGURE 194** Two leapfrogging vortex rings (QuickTime film © Lim Tee Tai)

Ref. 244

One of the most famous examples of fluid motion is the leapfrogging of vortex rings, shown in [Figure 194](#). Lim Tee Tai explains that more than two leapfrogs are extremely hard to achieve, because the slightest vortex ring misalignment leads to the collapse of the system.

\* \*

A surprising effect can be observed when pouring *shampoo* on a plate: sometimes a thin stream is ejected from the region where the shampoo hits the plate. This so-called Kaye effect is best enjoyed in the beautiful movie produced by the University of Twente found on the [youtube.com/watch?v=GX4\\_3cV\\_3Mw](http://youtube.com/watch?v=GX4_3cV_3Mw) website.



**FIGURE 195** How can you move the coin into the glass without touching anything?

### CURIOSITIES AND FUN CHALLENGES ABOUT SOLIDS

Glass is a solid. Nevertheless, many textbooks say that glass is a liquid. This error has been propagated for about a hundred years, probably originating from a mistranslation of a sentence in a German textbook published in 1933 by Gustav Tamman, *Der Glaszustand*.

**Challenge 538 s** Can you give at least three reasons why glass is a solid and not a liquid?

\* \*

What is the maximum length of a vertically hanging wire? Could a wire be lowered from a suspended geostationary satellite down to the Earth? This would mean we could realize a space 'lift'. How long would the cable have to be? How heavy would it be? How would you build such a system? What dangers would it face?

**Challenge 539 s**

\* \*

Physics is often good to win bets. See [Figure 195](#) for a way to do so, due to Wolfgang Stalla.

\* \*

Matter is made of atoms. Over the centuries the stubborn resistance of many people to this idea has led to the loss of many treasures. For over a thousand years, people thought that genuine pearls could be distinguished from false ones by hitting them with a hammer: only false pearls would break. However, *all* pearls break. (Also diamonds break in this situation.) Due to this belief, over the past centuries, all the most beautiful pearls in the world have been smashed to pieces.

\* \*

Comic books have difficulties with the concept of atoms. Could Asterix really throw Romans into the air using his fist? Are Lucky Luke's precise revolver shots possible? Can Spiderman's silk support him in his swings from building to building? Can the Roadrunner stop running in three steps? Can the Sun be made to stop in the sky by command? Can space-ships hover using fuel? Take any comic-book hero and ask yourself whether matter made of atoms would allow him the feats he seems capable of. You will find that most cartoons are comic precisely because they assume that matter is not made of atoms, but continuous! In a sense, atoms make life a serious adventure.

**Challenge 540 e**

\* \*

Challenge 541 s Can humans start earthquakes? What would happen if 1000 million Indians were to jump at the same time from the kitchen table to the floor?

In fact, several strong earthquakes *have* been triggered by humans. This has happened when water dams have been filled, or when water has been injected into drilling holes. It has also been suggested that the extraction of deep underground water also causes earthquakes. If this is confirmed by future research, a sizeable proportion of all earthquakes could be human-triggered.

\* \*

Challenge 542 s How can a tip of a stalactite be distinguished from a tip of a stalagmite? Does the difference exist also for icicles?

\* \*

Fractals do not exist. Which structures approximate them most closely? One candidate is the lung. Its bronchi divide over and over, between 26 and 28 times. Each end then arrives at one of the 300 million alveoli, the 0.25 mm cavities in which oxygen is absorbed into the blood and carbon dioxide is expelled in to the air.

\* \*

Challenge 543 s How much more weight would your bathroom scales show if you stood on them in a vacuum?

\* \*

One of the most complex extended bodies is the human body. In modern simulations of the behaviour of humans in car accidents, the most advanced models include ribs, vertebrae, all other bones and the various organs. For each part, its specific deformation properties are taken into account. With such models and simulations, the protection of passengers and drivers in cars can be optimized.

\* \*

Challenge 544 s The deepest hole ever drilled into the Earth is 12 km deep. In 2003, somebody proposed to enlarge such a hole and then to pour millions of tons of liquid iron into it. He claimed that the iron would sink towards the centre of the Earth. If a measurement device communication were dropped into the iron, it could send its observations to the surface using sound waves. Can you give some reasons why this would not work?

\* \*

The economic power of a nation has long been associated with its capacity to produce high-quality steel. Indeed, the Industrial Revolution started with the mass production of steel. Every scientist should know the basics facts about steel. *Steel* is a combination of iron and carbon to which other elements, mostly metals, may be added as well. One can distinguish three main types of steel, depending on the crystalline structure. *Ferritic steels* have a body-centred cubic structure, as shown in [Figure 196](#), *austenitic steels* have a face-centred cubic structure, and *martensitic steels* have a body-centred tetragonal structure. [Table 41](#) gives further details.



TABLE 41 Steel types, properties and uses.

FERRITIC STEEL	AUSTENITIC STEEL	MARTENSITIC STEEL
<b>Definition</b>		
'usual' steel body centred cubic (bcc) iron and carbon	'soft' steel face centred cubic (fcc) iron, chromium, nickel, manganese, carbon	hardened steel, brittle body centred tetragonal (bct) carbon steel and alloys
<b>Examples</b>		
construction steel	most stainless (18/8 Cr/Ni) steels	knife edges
car sheet steel	kitchenware	drill surfaces
ship steel	food industry	spring steel, crankshafts
12 % Cr stainless ferrite	Cr/V steels for nuclear reactors	
<b>Properties</b>		
phases described by the iron-carbon phase diagram	phases described by the Schaeffler diagram	phases described by the iron-carbon diagram and the TTT (time-temperature transformation) diagram
in equilibrium at RT	some alloys in equilibrium at RT	not in equilibrium at RT, but stable
mechanical properties and grain size depend on heat treatment	mechanical properties and grain size depend on thermo-mechanical pre-treatment	mechanical properties and grain size strongly depend on heat treatment
hardened by reducing grain size, by forging, by increasing carbon content or by nitration	hardened by cold working only	hard anyway – made by laser irradiation, induction heating, etc.
grains of ferrite and pearlite, with cementite (Fe <sub>3</sub> C)	grains of austenite	grains of martensite
ferromagnetic	not magnetic or weakly magnetic	ferromagnetic

\* \*

A simple phenomenon which requires a complex explanation is the cracking of a whip. Since the experimental work of Peter Krehl it has been known that the whip cracks when the tip reaches a velocity of *twice* the speed of sound. Can you imagine why?

\* \*

A bicycle chain is an extended object with no stiffness. However, if it is made to rotate rapidly, it acquires dynamical stiffness, and can roll down an inclined plane or along the floor. This surprising effect can be watched at the [www.iwf.de/iwf/medien/infothek?Signatur=C+14825](http://www.iwf.de/iwf/medien/infothek?Signatur=C+14825) website.

Ref. 245

Challenge 545 ny



**FIGURE 196** Ferritic steels are bcc (body centred cubic), as shown by the famous *Atomium* in Brussels, a section of an iron crystal magnified to a height of over 100 m (photo and building are © Asbl Atomium Vzw – SABAM Belgium 2007).

\* \*

Ref. 246 Mechanical devices are not covered in this text. There is a lot of progress in the area even  
 Ref. 247 at present. For example, people have built robots that are able to ride a unicycle. But  
 even the physics of human unicycling is not simple. Try it; it is an excellent exercise to  
 stay young.

\* \*

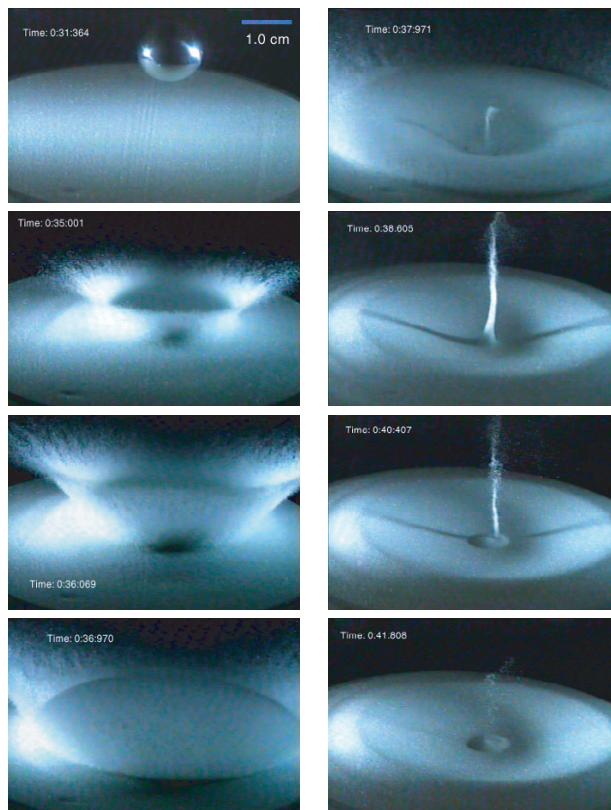
Ref. 248 There are many arguments against the existence of atoms as hard balls. Thomson-Kelvin  
 Challenge 546 s put it in writing: “the monstrous assumption of infinitely strong and infinitely rigid pieces  
 of matter.” Even though Thomson was right in his comment, atoms do exist. Why?

\* \*

Ref. 249 Sand has many surprising ways to move, and new discoveries are still made regularly. In  
 2001, Sigurdur Thoroddsen and Amy Shen discovered that a steel ball falling on a bed of  
 sand produces, after the ball has sunk in, a *granular jet* that jumps out upwards from the  
 sand. Figure 197 shows a sequence of photographs of the effect. The discovery has led to  
 a stream of subsequent research.

\* \*

Engineering is not a part of this text. Nevertheless, it is an interesting topic. A few exam-  
 ples of what engineers do are shown in Figure 198.



**FIGURE 197** An example of motion of sand: granular jets (© Amy Shen).



**FIGURE 198** Modern engineering highlights: a lithography machine for the production of integrated circuits and a paper machine (© ASML, Voith).

### SUMMARY ON EXTENSION

In the case of matter, there are no arbitrary small parts. Matter is made of countable components. This result has been confirmed for solids, liquids and gases. The discreteness of matter is one of the most important results of physics. Matter consists of atoms.

It will be shown later on that the discreteness is itself a consequence of the existence of a smallest change in nature.

TABLE 42 Extensive quantities in nature, i.e., quantities that *flow* and *accumulate*.

DOMAIN	EXTENSIVE QUANTITY (ENERGY CARRIER)	CURRENT (FLOW INTENSITY)	INTENSIVE QUANTITY (DRIVING STRENGTH)	ENERGY FLOW (POWER)	RESISTANCE TO TRANSPORT (INTENSITY OF ENTROPY GENERATION)
Rivers	mass $m$	mass flow $m/t$	height difference $gh$	$P = gh m/t$	$R_m = gh t/m$ [m <sup>2</sup> /s kg]
Gases	volume $V$	volume flow $V/t$	pressure $p$	$P = pV/t$	$R_V = p t/V$ [kg/s m <sup>5</sup> ]
Mechanics	momentum $p$	force $F = dp/dt$	velocity $v$	$P = v F$	$R_p = \Delta V/F = t/m$ [s/kg]
	angular momentum $L$	torque $M = dL/dt$	angular velocity $\omega$	$P = \omega M$	$R_L = t/mr^2$ [s/kg m <sup>2</sup> ]
Chemistry	amount of substance $n$	substance flow $I_n = dn/dt$	chemical potential $\mu$	$P = \mu I_n$	$R_n = \mu t/n$ [s/mol <sup>2</sup> ]
Thermodynamics	entropy $S$	entropy flow $I_S = dS/dt$	temperature $T$	$P = T I_S$	$R_S = T t/S$ [K <sup>2</sup> /W]
Light	like all massless radiation, it can flow but cannot accumulate				
Electricity	charge $q$	electrical current $I = dq/dt$	electrical potential $U$	$P = U I$	$R = U/I$ [Ω]
Magnetism	no accumulable magnetic sources are found in nature				
Nuclear physics	extensive quantities exist, but do not appear in everyday life				
Gravitation	empty space can move and flow, but the motion is not observed in everyday life				

### WHAT CAN MOVE IN NATURE? – FLOWS

Before we continue to the next way to describe motion globally, we will have a look at the possibilities of motion in everyday life. One overview is given in Table 42. The domains that belong to everyday life – motion of fluids, of matter, of matter types, of heat, of light and of charge – are the domains of continuum physics.

Within continuum physics, there are three domains we have not yet studied: the motion of charge and light, called electrodynamics, the motion of heat, called thermodynamics, and the motion of the vacuum. Once we have explored these domains, we will have completed the first step of our description of motion: continuum physics. In continuum physics, motion and moving entities are described with continuous quantities that can take any value, including arbitrarily small or arbitrarily large values.

But nature is *not* continuous. We have already seen that matter cannot be indefinitely



FIGURE 199 Sometimes unusual moving objects cross German roads (© RWE).

divided into ever-smaller entities. In fact, we will discover that there are precise experiments that provide limits to the observed values for *every* domain of continuum physics. There is a limit to mass, to speed, to angular momentum, to force, to entropy and to change of charge. The consequences of these discoveries form the second step in our description of motion: quantum theory and relativity. Quantum theory is based on lower limits; relativity is based on upper limits. The third and last step of our description of motion will be formed by the unification of quantum theory and general relativity.

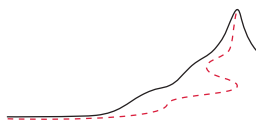
Every domain of physics, regardless of which one of the above steps it belongs to, describes change in terms two quantities: energy, and an extensive quantity characteristic of the domain. An observable quantity is called *extensive* if it increases with system size. [Table 42](#) provides an overview. The intensive and extensive quantities corresponding to what in everyday language is called ‘heat’ are *temperature* and *entropy*.

The analogies of the table can be carried even further. In all domains, the *capacity* of a system is defined by the extensive quantity divided by the intensive quantity. The capacity measures, how much easily stuff flows into the system. For electric charge the capacity is the usual electric capacity. For momentum, the capacity is called mass. Mass measures, how easily one can put momentum into a system. Can you determine the quantities that measure capacity in the other cases?

Similarly, in all fields it is possible to store energy by using the intensive quantity – such as  $E = CU^2/2$  in a capacitor or  $E = mv^2/2$  in a moving body – or by using the extensive quantity – such as  $E = LI^2/2$  in a coil or  $E = F^2/2k$  in a spring. Combining the two, we get oscillations. Can you extend the analogy to the other cases?







## FROM HEAT TO TIME-INVARIANCE

Spilled milk never returns into its container by itself. Any hot object, left alone, cools down with time; it never heats up. These and many other observations show that numerous processes in nature are *irreversible*. Does this mean that motion is not time-reversal-invariant, as Nobel Prize winner Ilya Prigogine thought? We discuss the issue in this section.

Ref. 251 All irreversible phenomena involve heat. Thus we need to know the basic facts about heat in order to discuss irreversibility. The main points that are taught in secondary school are almost sufficient.

## TEMPERATURE

Macroscopic bodies, i.e., bodies made of many atoms, have temperature. The temperature of a macroscopic body is an aspect of its state. It is observed that any two bodies in contact tend towards the *same* temperature: temperature is contagious. In other words, temperature describes an equilibrium situation. The existence and contagiousness of temperature is often called the *zeroth principle of thermodynamics*. Heating is the increase of temperature, cooling its decrease.

How is temperature measured? The eighteenth century produced the clearest answer: temperature is best defined and measured by the *expansion of gases*. For the simplest, so-called *ideal* gases, the product of pressure  $p$  and volume  $V$  is proportional to temperature:

$$pV \sim T . \quad (104)$$

Ref. 252  
Page 347  
Challenge 549 ny  
The proportionality constant is fixed by the *amount* of gas used. (More about it shortly.) The ideal gas relation allows us to determine temperature by measuring pressure and volume. This is the way (absolute) temperature has been defined and measured for about a century. To define the *unit* of temperature, one only has to fix the amount of gas used. It is customary to fix the amount of gas at 1 mol; for oxygen this is 32 g. The proportionality constant, called the *ideal gas constant*  $R$ , is defined to be  $R = 8.3145 \text{ J/mol K}$ . This number has been chosen in order to yield the best approximation to the independently defined Celsius temperature scale. Fixing the ideal gas constant in this way defines 1 K, or one Kelvin, as the unit of temperature. In simple terms, a temperature increase of one Kelvin is defined as the temperature increase that makes the volume of an ideal gas increase – keeping the pressure fixed – by a fraction of  $1/273.15$  or 0.3661 %.

Temperature is an aspect of the *state* of a body. In other words, two identical bodies

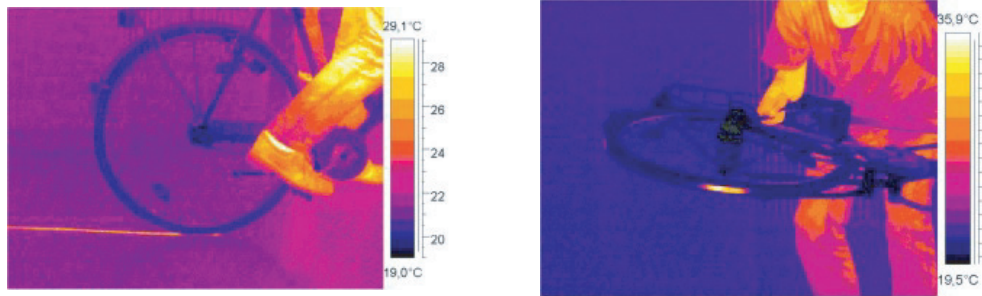


FIGURE 200 Braking generates heat on the floor and in the tire (© Klaus-Peter Möllmann and Michael Vollmer).



FIGURE 201 A rigged lottery (© ISTA).

Ref. 253

can be characterized and distinguished by their temperature. This is well-known to criminal organizations around the world that rig lotteries. When a blind-folded child is asked to draw a numbered ball from a set of such balls, it is often told beforehand to draw only *hot* or *cold* balls. The blindfolding also helps to hide the tears due to the pain.

In general, if one needs to determine the temperature of an object, one takes a mole of gas, puts it in contact with the object, waits a while, and then measures the pressure and the volume of the gas. The ideal gas relation (104) then gives the temperature. Most importantly, the ideal gas relation shows that there is a lowest temperature in nature, namely that temperature at which an ideal gas would have a vanishing volume. That would happen at  $T = 0$  K, i.e., at  $-273.15^\circ\text{C}$ . Obviously, other effects, like the volume of the atoms themselves, prevent the volume of the gas from ever reaching zero. In fact, the unattainability of absolute zero is called the *third principle of thermodynamics*.

The temperature achieved by a civilization can be used as a measure of its technological achievements. One can define the Bronze Age (1.1 kK, 3500 BCE), the Iron Age (1.8 kK, 1000 BCE), the Electric Age (3 kK from c. 1880) and the Atomic Age (several MK, from 1944) in this way. Taking into account also the quest for lower temperatures,





**FIGURE 202** Thermometers: a Galilean thermometer (left), the row of infrared sensors in the jaw of the emerald tree boa *Corallus caninus*, an infrared thermometer to measure body temperature in the ear, a nautical thermometer using a bimetal, a mercury thermometer, and a thermocouple that is attached to a voltmeter for read-out (© Wikimedia, Ron Marcus, Braun GmbH, Universum, Wikimedia, Thermodevices).

Ref. 254 one can define the Quantum Age (4 K, starting 1908). But what exactly is heating and cooling?

### THERMAL ENERGY

Heating and cooling is the flow of disordered energy. For example, friction heats up and slows down moving bodies. In the old days, the ‘creation’ of heat by friction was even tested experimentally. It was shown that heat could be generated from friction, just by continuous rubbing, without any limit; an example is shown in Figure 200. This ‘creation’ implies that heat is not a material fluid extracted from the body – which in this case would be consumed after a certain time – but something else. Indeed, today we know

Ref. 255

TABLE 43 Some temperature values.

OBSERVATION	TEMPERATURE
Lowest, but unattainable, temperature	0 K = $-273.15^{\circ}\text{C}$
In the context of lasers, it sometimes makes (almost) sense to talk about negative temperature.	
Temperature a perfect vacuum would have at Earth's surface Vol. V, Page 102	40 zK
Sodium gas in certain laboratory experiments – coldest matter system achieved by man and possibly in the universe	0.45 nK
Temperature of neutrino background in the universe	<i>c.</i> 2 K
Temperature of photon gas background (or background radiation) in the universe	2.7 K
Liquid helium	4.2 K
Oxygen triple point	54.3584 K
Liquid nitrogen	77 K
Coldest weather ever measured (Antarctic)	185 K = $-88^{\circ}\text{C}$
Freezing point of water at standard pressure	273.15 K = $0.00^{\circ}\text{C}$
Triple point of water	273.16 K = $0.01^{\circ}\text{C}$
Average temperature of the Earth's surface	287.2 K
Smallest uncomfortable skin temperature	316 K (10 K above normal)
Interior of human body	$310.0 \pm 0.5$ K = $36.8 \pm 0.5^{\circ}\text{C}$
Hottest weather ever measured	343.8 K = $70.7^{\circ}\text{C}$
Boiling point of water at standard pressure	373.13 K or $99.975^{\circ}\text{C}$
Large wood fire	<i>c.</i> 1100 K
Liquid bronze	<i>c.</i> 1100 K
Freezing point of gold	1337.33 K
Liquid, pure iron	1810 K
Bunsen burner flame	up to 1870 K
Light bulb filament	2.9 kK
Earth's centre	4 kK
Melting point of hafnium carbide	4.16 kK
Sun's surface	5.8 kK
Air in lightning bolt	30 kK
Hottest star's surface (centre of NGC 2240)	250 kK
Space between Earth and Moon (no typo)	up to 1 MK
Centre of white dwarf	5 to 20 MK
Sun's centre	20 MK
Centre of the accretion disk in X-ray binary stars	10 to 100 MK
Inside the JET fusion tokamak	100 MK
Centre of hottest stars	1 GK
Maximum temperature of systems without electron-positron pair generation	ca. 6 GK
Universe when it was 1 s old	100 GK
Hagedorn temperature	1.9 TK
Heavy ion collisions – highest man-made value	up to 3.6 TK
Planck temperature – nature's upper temperature limit	$10^{32}$ K

that heat, even though it behaves in some ways like a fluid, is due to disordered motion of particles. The conclusion of these studies is simple. Friction is the transformation of mechanical (i.e., ordered) energy into (disordered) *thermal energy*.

To heat 1 kg of water by 1 K by friction, 4.2 kJ of mechanical energy must be transformed through friction. The first to measure this quantity with precision was, in 1842, the German physician Julius Robert Mayer (1814–1878). He regarded his experiments as proofs of the conservation of energy; indeed, he was the first person to state energy conservation! It is something of an embarrassment to modern physics that a medical doctor was the first to show the conservation of energy, and furthermore, that he was ridiculed by most physicists of his time. Worse, conservation of energy was accepted by scientists only when it was repeated many years later by two authorities: Hermann von Helmholtz – himself also a physician turned physicist – and William Thomson, who also cited similar, but later experiments by James Joule.\* All of them acknowledged Mayer's priority. Publicity by William Thomson eventually led to the naming of the unit of energy after Joule.

In short, the sum of mechanical energy and thermal energy is constant. This is usually called the *first principle of thermodynamics*. Equivalently, it is impossible to produce mechanical energy without paying for it with some other form of energy. This is an important statement, because among others it means that humanity will stop living one day. Indeed, we live mostly on energy from the Sun; since the Sun is of finite size, its energy content will eventually be consumed. Can you estimate when this will happen?

Challenge 550 s

The first principle allows us to formulate in precise terms what happens in a car engine. Car engines are devices that transform hot matter – the hot exploding fuel inside the cylinders – into motion of the car wheels. Car engines are thus examples of *heat engines*. Another example are steam engines. Every heat engine needs cooling; that is the reason for the holes in the front of cars. Indeed, the first principle of thermodynamics states that the mechanical power of a heat engine is the difference between the inflow of thermal energy at high temperature and the outflow of thermal energy at low temperature. If the cooling is insufficient – for example, because the weather is too hot or the car speed too low – the power of the engine is reduced. Every driver knows this.

There is also a second – and the mentioned third – principle of thermodynamics, which will be presented later on. The study of these topics is called *thermostatics* if the systems concerned are at equilibrium, and *thermodynamics* if they are not. In the latter case, we distinguish situations *near* equilibrium, when equilibrium concepts such as temperature can still be used, from situations *far* from equilibrium, such as self-organization, where such concepts often cannot be applied.

Page 318

Does it make sense to distinguish between thermal energy and heat? It does. Many older texts use the term 'heat' to mean the same as thermal energy. However, this is confusing; in this text, 'heat' is used, in accordance with modern approaches, as the everyday term for entropy. Both thermal energy and heat flow from one body to another, and both accumulate. Both have no measurable mass.\*\* Both the amount of thermal energy and

\* Hermann von Helmholtz (b. 1821 Potsdam, d. 1894 Berlin), important Prussian scientist. William Thomson (later William Kelvin) (1824–1907), important Irish physicist. James Prescott Joule (1818–1889), English physicist. Joule is pronounced so that it rhymes with 'cool', as his descendants like to stress. (The pronunciation of the name 'Joule' varies from family to family.)

\*\* This might change in future, when mass measurements improve in precision, thus allowing the detection

the amount of heat inside a body increase with increasing temperature. The precise relation will be given shortly. But heat has many other interesting properties and stories to tell. Of these, two are particularly important: first, heat is due to particles; and secondly, heat is at the heart of the difference between past and future. These two stories are intertwined.

## ENTROPY

“ – It’s irreversible.  
– Like my raincoat!”  
Mel Brooks, *Spaceballs*, 1987

Ref. 250

Every domain of physics describes change in terms of three quantities: energy, as well as an intensive and an extensive quantity characteristic of the domain. In the domain of thermal physics, the intensive quantity is temperature. What is the extensive quantity?

The obvious guess would be ‘heat’. Unfortunately, the quantity that physicists usually call ‘heat’ is not the same as what we call ‘heat’ in our everyday speech. For this historical reason, we need to introduce a new term. The extensive quantity corresponding to what we call ‘heat’ in everyday speech is called *entropy* in physics.\* Entropy is measured in joule per kelvin. Some example values are given in Table 44. Entropy describes everyday heat in the same way as momentum describes everyday motion. When two objects of different speeds collide, a flow of momentum takes place between them. Similarly, when two objects differing in temperature are brought into contact, an entropy flow takes place between them. Let us define the concept of entropy – ‘everyday heat’ – more precisely and explore its properties in some more detail.

*Entropy* measures the degree to which energy is *mixed up* inside a system, that is, the degree to which energy is spread or shared among the components of a system. When all components of a system – usually the molecules or atoms – move in the same way, *in concert*, the entropy of the system is low. When the components of the system move completely independently, *randomly*, the entropy is large.

Entropy *adds up* when identical systems are composed into one. When two one-litre bottles of water at the same temperature are poured together, the entropy of the water adds up. In short, entropy is an extensive quantity.

Like any other extensive quantity, entropy can be accumulated in a body, and entropy can flow into or out of bodies. When we transform water into steam by heating it, we say that we add entropy to the water. After the water has become steam, the added entropy is contained in the steam. In short, entropy is the exact term for what we call ‘heat’ in everyday speech.

In contrast to several other important extensive quantities, entropy is *not* conserved. On the one hand, in closed systems, entropy accumulates and never decreases; the sharing or mixing of energy among the components of a system cannot be undone. On the

Vol. II, page 64

of relativistic effects. In this case, temperature increase may be detected through its related mass increase. However, such changes are noticeable only with twelve or more digits of precision in mass measurements.

\* The term ‘entropy’ was invented by the German physicist Rudolph Clausius (1822–1888) in 1865. He formed it from the Greek ἐν ‘in’ and τρόπος ‘direction’, to make it sound similar to ‘energy’. Entropy has always had the meaning given here.

In contrast, what physicists call ‘heat’ is a form of energy and not an extensive quantity in general.

TABLE 44 Some measured entropy values.

PROCESS / SYSTEM	ENTROPY VALUE
Melting of 1 kg of ice	1.21 kJ/K kg = 21.99 J/K mol
Water under standard conditions	70.1 J/K mol
Boiling of 1 kg of liquid water at 101.3 kPa	6.03 kJ/K = 110 J/K mol
Iron under standard conditions	27.2 J/K mol
Oxygen under standard conditions	161.1 J/K mol

other hand, the sharing or mixing can increase spontaneously over time. Entropy is thus only ‘half conserved’. What we call thermal equilibrium is simply the result of the highest possible mixing. Entropy allows us to define the concept of *equilibrium* more precisely as the state of maximum entropy, or maximum energy sharing among the components of a system. In short, the entropy of a closed system increases until it reaches the maximum possible value, the equilibrium value.

The non-conservation of entropy has far-reaching consequences. When a piece of rock is detached from a mountain, it falls, tumbles into the valley, heating up a bit, and eventually stops. The opposite process, whereby a rock cools and tumbles upwards, is never observed. Why? We could argue that the opposite motion does not contradict any rule or pattern about motion that we have deduced so far.

Challenge 551 s

Rocks never fall upwards because mountains, valleys and rocks are made of *many* particles. Motions of many-particle systems, especially in the domain of thermodynamics, are called *processes*. Central to thermodynamics is the distinction between *reversible* processes, such as the flight of a thrown stone, and *irreversible* processes, such as the afore-mentioned tumbling rock. Irreversible processes are all those processes in which friction and its generalizations play a role. Irreversible processes are those processes that increase the sharing or mixing of energy. They are important: if there were no friction, shirt buttons and shoelaces would not stay fastened, we could not walk or run, coffee machines would not make coffee, and maybe most importantly of all, we would have no memory.

Ref. 256

Vol. IV, page 133

Irreversible processes, in the sense in which the term is used in thermodynamics, transform macroscopic motion into the disorganized motion of all the small microscopic components involved: they increase the sharing and mixing of energy. Irreversible processes are therefore not *strictly* irreversible – but their reversal is *extremely* improbable. We can say that entropy measures the ‘amount of irreversibility’: it measures the degree of mixing or decay that a collective motion has undergone.

Entropy is not conserved. Indeed, entropy – ‘heat’ – can appear out of nowhere, spontaneously, because energy sharing or mixing can happen by itself. For example, when two different liquids of the same temperature are mixed – such as water and sulphuric acid – the final temperature of the mix can differ. Similarly, when electrical current flows through material at room temperature, the system can heat up or cool down, depending on the material.

The *second principle of thermodynamics* states

*The entropy in a closed system tends towards its maximum.*

In sloppy terms, ‘entropy ain’t what it used to be.’ Here, a *closed system* is a system that does not exchange energy or matter with its environment. Can you think of an example?

Challenge 552 ny

In a closed system, entropy never decreases. Even everyday life shows us that in a closed system, such as a room, the disorder increases with time, until it reaches some maximum. To reduce disorder, we need effort, i.e., work and energy. In other words, in order to reduce the disorder in a system, we need to connect the system to an energy source in some clever way. For this reason, refrigerators need electrical current or some other energy source.

Ref. 257

In 1866, Ludwig Boltzmann showed that the second principle of thermodynamics results from the principle of least action. Can you imagine and sketch the general ideas?

Challenge 553 ny

Because entropy never decreases in closed systems, *white colour does not last*. Whenever disorder increases, the colour white becomes ‘dirty’, usually grey or brown. Perhaps for this reason white objects, such as white clothes, white houses and white underwear, are valued in our society. White objects defy decay.

In summary, the concept of entropy, corresponding to what is called ‘heat’ in everyday life – but *not* to what is called ‘heat’ in physics! – describes the randomness of the internal motion in matter. Entropy is not conserved: in a closed system, entropy never decreases, but it can increase until it reaches a maximum value. The non-conservation of entropy is due to the many components inside everyday systems. The large number of components lead to the non-conservation of entropy and therefore explain, among many other things, that many processes in nature never occur backwards, even though they could do so in principle.

### FLOW OF ENTROPY

We know from daily experience that transport of an extensive quantity always involves friction. Friction implies generation of entropy. In particular, the flow of entropy itself produces additional entropy. For example, when a house is heated, entropy is produced in the wall. Heating means to keep a temperature difference  $\Delta T$  between the interior and the exterior of the house. The heat flow  $J$  traversing a square metre of wall is given by

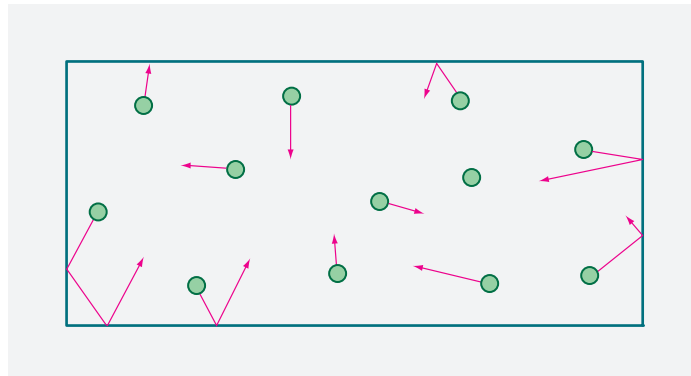
$$J = \kappa \Delta T = \kappa(T_i - T_e) \quad (105)$$

where  $\kappa$  is a constant characterizing the ability of the wall to conduct heat. While conducting heat, the wall also *produces* entropy. The entropy production  $\sigma$  is proportional to the difference between the interior and the exterior entropy flows. In other words, one has

$$\sigma = \frac{J}{T_e} - \frac{J}{T_i} = \kappa \frac{(T_i - T_e)^2}{T_i T_e}. \quad (106)$$

Note that we have assumed in this calculation that everything is near equilibrium in each slice parallel to the wall, a reasonable assumption in everyday life. A typical case of a good wall has  $\kappa = 1 \text{ W/m}^2\text{K}$  in the temperature range between 273 K and 293 K. With





**FIGURE 203** The basic idea of statistical mechanics about gases: gases are systems of moving particles, and pressure is due to their collisions with the container.

this value, one gets an entropy production of

$$\sigma = 5 \cdot 10^{-3} \text{ W/m}^2\text{K} . \quad (107)$$

Challenge 554 ny

Can you compare the amount of entropy that is produced in the flow with the amount that is transported? In comparison, a good goose-feather duvet has  $\kappa = 1.5 \text{ W/m}^2\text{K}$ , which in shops is also called 15 tog.\*

Entropy can be transported in three ways: through *heat conduction*, as just mentioned, via *convection*, used for heating houses, and through *radiation*, which is possible also through empty space. For example, the Earth radiates about  $1.2 \text{ W/m}^2\text{K}$  into space, in total thus about  $0.51 \text{ PW/K}$ . The entropy is (almost) the same that the Earth receives from the Sun. If more entropy had to be radiated away than received, the temperature of the surface of the Earth would have to increase. This is called the *greenhouse effect* or *global warming*. Let's hope that it remains small in the near future.

#### DO ISOLATED SYSTEMS EXIST?

In all our discussions so far, we have assumed that we can distinguish the system under investigation from its environment. But do such *isolated* or *closed* systems, i.e., systems not interacting with their environment, actually exist? Probably our own human condition was the original model for the concept: we do experience having the possibility to act independently of our environment. An isolated system may be simply defined as a system not exchanging any energy or matter with its environment. For many centuries, scientists saw no reason to question this definition.

The concept of an isolated system had to be refined somewhat with the advent of quantum mechanics. Nevertheless, the concept provides useful and precise descriptions of nature also in that domain. Only in the final part of our walk will the situation change

\* That unit is not as bad as the official (not a joke)  $\text{BthU} \cdot \text{h/sqft/cm}^{\circ}\text{F}$  used in some remote provinces of our galaxy.

The insulation power of materials is usually measured by the constant  $\lambda = \kappa d$  which is independent of the thickness  $d$  of the insulating layer. Values in nature range from about  $2000 \text{ W/K m}$  for diamond, which is the best conductor of all, down to between  $0.1 \text{ W/K m}$  and  $0.2 \text{ W/K m}$  for wood, between  $0.015 \text{ W/K m}$  and  $0.05 \text{ W/K m}$  for wools, cork and foams, and the small value of  $5 \cdot 10^{-3} \text{ W/K m}$  for krypton gas.





FIGURE 204 What happened here? (© Johan de Jong)

Challenge 555 s

drastically. There, the investigation of whether the universe is an isolated system will lead to surprising results. (What do you think?)\* We'll take the first steps towards the answer shortly.

#### WHY DO BALLOONS TAKE UP SPACE? – THE END OF CONTINUITY

Heat properties are material-dependent. Studying them should therefore enable us to understand something about the constituents of matter. Now, the simplest materials of all are gases.\*\* Gases need space: an amount of gas has pressure and volume. Indeed, it did not take long to show that gases *could not* be continuous. One of the first scientists to think about gases as made up of atoms was Daniel Bernoulli. Bernoulli reasoned that if atoms are small particles, with mass and momentum, he should be able to make quantitative predictions about the behaviour of gases, and check them with experiment. If the particles fly around in a gas, then the *pressure* of a gas in a container is produced by the steady flow of particles hitting the wall. It was then easy to conclude that if the particles are assumed to behave as tiny, hard and perfectly elastic balls, the pressure  $p$ , volume  $V$  and temperature  $T$  must be related by

Challenge 556 ny

$$pV = kNT \quad (108)$$

where  $N$  is the number of particles contained in the gas. (The Boltzmann constant  $k$ , one of the fundamental constants of nature, is defined below.) A gas made of particles with such textbook behaviour is called an *ideal gas*. Relation (108) has been confirmed by experiments at room and higher temperatures, for all known gases.

\* A strange hint: your answer is almost surely wrong.

\*\* By the way, the word *gas* is a modern construct. It was coined by the Brussels alchemist and physician Johan Baptista van Helmont (1579–1644), to sound similar to ‘chaos’. It is one of the few words which have been invented by one person and then adopted all over the world.

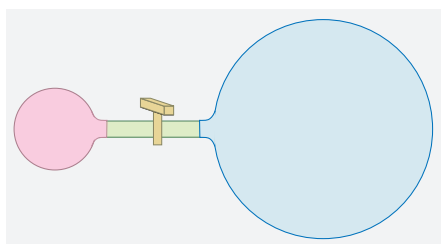


FIGURE 205 Which balloon wins when the tap is opened?

Bernoulli thus derived the gas relation, with a specific prediction for the proportionality constant, from the single assumption that gases are made of small massive constituents. This derivation provides a clear argument for the existence of atoms and for their behaviour as normal, though small objects. (Can you imagine how  $N$  might be determined experimentally?)

Challenge 557 ny

The ideal gas model helps us to answer questions such as the one illustrated in Figure 205. Two *identical* rubber balloons, one filled up to a larger size than the other, are connected via a pipe and a valve. The valve is opened. Which one deflates?

Challenge 558 s

The ideal gas relation states that hotter gases, at given pressure, need more volume. The relation thus explains why winds and storms exist, why hot air balloons rise, why car engines work, why the ozone layer is destroyed by certain gases, or why during the extremely hot summer of 2001 in the south of Turkey, oxygen masks were necessary to walk outside during the day.

Challenge 559 e

Now you can also take up the following challenge: how can you measure the weight of a car or a bicycle with a ruler only?

Challenge 560 s

The picture of gases as being made of hard constituents without any long-distance interactions breaks down at very low temperatures. However, the ideal gas relation (108) can be improved to overcome these limitations by taking into account the deviations due to interactions between atoms or molecules. This approach is now standard practice and allows us to measure temperatures even at extremely low values. The effects observed below 80 K, such as the solidification of air, frictionless transport of electrical current, or frictionless flow of liquids, form a fascinating world of their own, the beautiful domain of low-temperature physics; it will be explored later on.

Ref. 258

Ref. 259

Vol. V, page 62

Vol. V, page 69

You are now able to explain why balloons change in size as they rise high up in the atmosphere. The largest balloon built so far had a diameter, at high altitude, of 170 m, but only a fraction of that value at take-off.

Challenge 561 e

### BROWNIAN MOTION

If fluids are made of particles moving randomly, this random motion should have observable effects. Indeed, under a microscope it is easy to observe that small particles, such as coal dust, in or on a liquid never come to rest. An example of the observed motion is shown in Figure 206. The particles seem to follow a random zigzag movement. This was first described by Lucretius, in the year 60 BCE, in his poem *De natura rerum*. He describes what everybody has seen: the dance of dust particles in air that is illuminated by the Sun.

In 1785, Jan Ingenhousz saw that coal dust particles never come to rest. He discovered

what is called *Brownian motion* today. 40 years after him, the botanist Robert Brown was the first Englishman to repeat the observation, this time for small particles floating in vacuoles *inside* pollen. Further experiments showed that the observation of a random motion is independent of the type of particle and of the type of liquid. In other words, Ingenhousz had discovered a fundamental form of *noise* in nature. Around 1860, the random motion of particles in liquids was attributed to the molecules of the liquid colliding with the particles by various people. In 1905 and 1906, Marian von Smoluchowski and, independently, Albert Einstein argued that this attribution could be tested experimentally, even though at that time nobody was able to observe molecules directly. The test makes use of the specific properties of thermal noise.

Ref. 260

It had already been clear for a long time that if molecules, i.e., indivisible matter particles, really existed, then thermal energy had to be disordered motion of these constituents and temperature had to be the average energy per degree of freedom of the constituents. Bernoulli's model of Figure 203 implies that for monatomic gases the kinetic energy  $T_{\text{kin}}$  per particle is given by

Challenge 562 ny

$$T_{\text{kin}} = \frac{3}{2}kT \quad (109)$$

where  $T$  is temperature. The so-called *Boltzmann constant*  $k = 1.4 \cdot 10^{-23}$  J/K is the standard conversion factor between temperature and energy.\*At a room temperature of 293 K, the kinetic energy is thus 6 zJ.

Challenge 563 e

Using relation (109) to calculate the speed of air molecules at room temperature yields values of several hundred metres per second. Given this large speed, why does smoke from a candle take so long to diffuse through a room? Rudolph Clausius (1822–1888) answered this question in the mid-nineteenth century: smoke diffusion is slowed by the collisions with air molecules, in the same way as pollen particles collide with molecules in liquids.

At first sight, one could guess that the average distance the pollen particle has moved after  $n$  collisions should be zero, because the molecule velocities are random. However, this is wrong, as experiment shows.

Challenge 564 ny

An increasing average *square* displacement, written  $\langle d^2 \rangle$ , is observed for the pollen particle. It cannot be predicted in which direction the particle will move, but it does move. If the distance the particle moves after one collision is  $l$ , the average square displacement after  $n$  collisions is given, as you should be able to show yourself, by

$$\langle d^2 \rangle = nl^2 . \quad (110)$$

Vol. III, page 118

\* The Boltzmann constant  $k$  was discovered and named by Max Planck, in the same work in which he also discovered what is now called Planck's constant  $h$ , the quantum of action. For more details on Max Planck, see later on.

Planck named the Boltzmann constant after the important Austrian physicist Ludwig Boltzmann (b. 1844 Vienna, d. 1906 Duino), who is most famous for his work on thermodynamics. Boltzmann he explained all thermodynamic phenomena and observables, above all entropy itself, as results of the behaviour of molecules. It is said that Boltzmann committed suicide partly because of the animosities of his fellow physicists towards his ideas and himself. Nowadays, his work is standard textbook material.

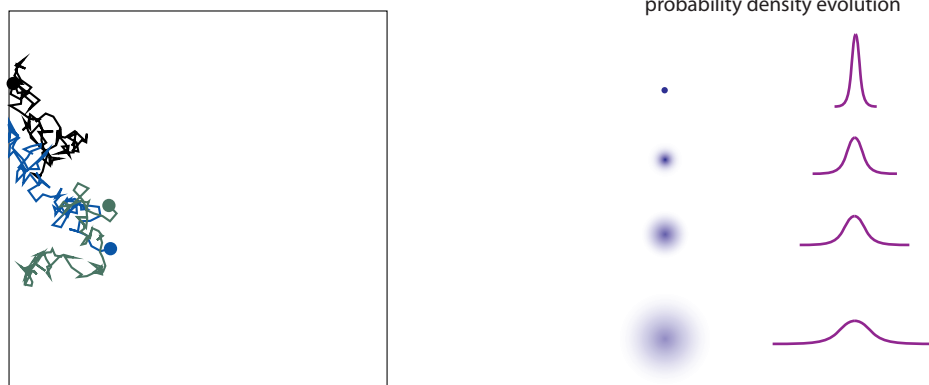


FIGURE 206 Example paths for particles in Brownian motion and their displacement distribution.

For molecules with an average velocity  $v$  over time  $t$  this gives

$$\langle d^2 \rangle = n l^2 = v l t . \quad (111)$$

In other words, the average square displacement increases proportionally with time. Of course, this is only valid because the liquid is made of separate molecules. Repeatedly measuring the position of a particle should give the distribution shown in Figure 206 for the probability that the particle is found at a given distance from the starting point. This is called the (*Gaussian*) *normal distribution*. In 1908, Jean Perrin\* performed extensive experiments in order to test this prediction. He found that equation (111) corresponded completely with observations, thus convincing everybody that Brownian motion is indeed due to collisions with the molecules of the surrounding liquid, as had been expected.\*\* Perrin received the 1926 Nobel Prize for these experiments.

Ref. 261

Einstein also showed that the same experiment could be used to determine the number of molecules in a litre of water (or equivalently, the Boltzmann constant  $k$ ). Can you work out how he did this?

Challenge 565 d

### ENTROPY AND PARTICLES

Once it had become clear that heat and temperature are due to the motion of microscopic particles, people asked what entropy *was* microscopically. The answer can be formulated in various ways. The two most extreme answers are:

- Entropy is the expected number of yes-or-no questions, multiplied by  $k \ln 2$ , the answers of which would tell us everything about the system, i.e., about its microscopic

\* Jean Perrin (1870–1942), important French physicist, devoted most of his career to the experimental proof of the atomic hypothesis and the determination of Avogadro's number; in pursuit of this aim he perfected the use of emulsions, Brownian motion and oil films. His Nobel Prize speech ([nobelprize.org/physics/laureates/1926/perrin-lecture.html](http://nobelprize.org/physics/laureates/1926/perrin-lecture.html)) tells the interesting story of his research. He wrote the influential book *Les atomes* and founded the Centre National de la Recherche Scientifique. He was also the first to speculate, in 1901, that an atom is similar to a small solar system.

Ref. 262

Page 324

\*\* In a delightful piece of research, Pierre Gaspard and his team showed in 1998 that Brownian motion is also chaotic, in the strict physical sense given later on.

**TABLE 45** Some typical entropy values per particle at *standard* temperature and pressure as multiples of the Boltzmann constant.

MATERIAL	ENTROPY PER PARTICLE
Monatomic solids	0.3 $k$ to 10 $k$
Diamond	0.29 $k$
Graphite	0.68 $k$
Lead	7.79 $k$
Monatomic gases	15-25 $k$
Helium	15.2 $k$
Radon	21.2 $k$
Diatomic gases	15 $k$ to 30 $k$
Polyatomic solids	10 $k$ to 60 $k$
Polyatomic liquids	10 $k$ to 80 $k$
Polyatomic gases	20 $k$ to 60 $k$
Icosane	112 $k$

state.

- Entropy measures the (logarithm of the) number  $W$  of possible microscopic states. A given macroscopic state can have many microscopic realizations. The logarithm of this number, multiplied by the Boltzmann constant  $k$ , gives the entropy.\*

In short, the higher the entropy, the more microstates are possible. Through either of these definitions, entropy measures the quantity of randomness in a system. In other words, it measures the transformability of energy: higher entropy means lower transformability. Alternatively, entropy measures the *freedom* in the choice of microstate that a system has. High entropy means high freedom of choice for the microstate. For example, when a molecule of glucose (a type of sugar) is produced by photosynthesis, about 40 bits of entropy are released. This means that after the glucose is formed, 40 additional yes-or-no questions must be answered in order to determine the full microscopic state of the system. Physicists often use a macroscopic unit; most systems of interest are large, and thus an entropy of  $10^{23}$  bits is written as 1 J/K. (This is only approximate. Can you find the precise value?)

Challenge 566 ny

Ref. 263

To sum up, entropy is thus a specific measure for the characterization of disorder of thermal systems. Three points are worth making here. First of all, entropy is not *the* measure of disorder, but *one* measure of disorder. It is therefore *not* correct to use entropy as a *synonym* for the concept of disorder, as is often done in the popular literature. Entropy is only defined for systems that have a temperature, in other words, only for systems that are in or near equilibrium. (For systems far from equilibrium, no measure of disorder

\* When Max Planck went to Austria to search for the anonymous tomb of Boltzmann in order to get him buried in a proper grave, he inscribed the formula  $S = k \ln W$  on the tombstone. (Which physicist would finance the tomb of another, nowadays?)

has been found yet; probably none is possible.) In fact, the use of the term entropy has degenerated so much that sometimes one has to call it *thermodynamic* entropy for clarity.

Secondly, entropy is related to information *only if* information is defined also as  $-k \ln W$ . To make this point clear, take a book with a mass of one kilogram. At room temperature, its entropy content is about 4 kJ/K. The printed information inside a book, say 500 pages of 40 lines with each containing 80 characters out of 64 possibilities, corresponds to an entropy of  $4 \cdot 10^{-17}$  J/K. In short, what is usually called ‘information’ in everyday life is a negligible fraction of what a physicist calls information. Entropy is defined using the *physical* concept of information.

Ref. 264

Challenge 567 ny

Finally, entropy is also *not* a measure for what in normal life is called the *complexity* of a situation. In fact, nobody has yet found a quantity describing this everyday notion. The task is surprisingly difficult. Have a try!

In summary, if you hear the term entropy used with a different meaning than  $S = k \ln W$ , beware. Somebody is trying to get you, probably with some ideology.

### THE MINIMUM ENTROPY OF NATURE – THE QUANTUM OF INFORMATION

Before we complete our discussion of thermal physics we must point out in another way the importance of the Boltzmann constant  $k$ . We have seen that this constant appears whenever the granularity of matter plays a role; it expresses the fact that matter is made of small basic entities. The most striking way to put this statement is the following: *There is a smallest entropy in nature*. Indeed, for all systems, the entropy obeys

$$S \geq k . \quad (112)$$

Ref. 265

Ref. 266

This result is almost 100 years old; it was stated most clearly (with a different numerical factor) by the Hungarian–German physicist Leo Szilard. The same point was made by the French physicist Léon Brillouin (again with a different numerical factor). The statement can also be taken as the *definition* of the Boltzmann constant.

The existence of a smallest entropy in nature is a strong idea. It eliminates the possibility of the continuity of matter and also that of its fractality. A smallest entropy implies that matter is made of a finite number of small components. The limit to entropy expresses the fact that matter is made of particles.\* The limit to entropy also shows that Galilean physics cannot be correct: Galilean physics assumes that arbitrarily small quantities do exist. The entropy limit is the first of several limits to motion that we will encounter until we complete the quantum part of our ascent. After we have found all limits, we can start the final part, leading to unification.

The existence of a smallest quantity implies a limit on the precision of measurement. Measurements cannot have infinite precision. This limitation is usually stated in the form of an indeterminacy relation. Indeed, the existence of a smallest entropy can be rephrased as an indeterminacy relation between the temperature  $T$  and the inner energy  $U$  of a

\* The minimum entropy implies that matter is made of tiny spheres; the minimum *action*, which we will encounter in quantum theory, implies that these spheres are actually small clouds.

system:

$$\Delta \frac{1}{T} \Delta U \geq \frac{k}{2}. \quad (113)$$

Ref. 268 This relation\* was given by Niels Bohr; it was discussed by Werner Heisenberg, who  
Vol. VI, page 26 called it one of the basic indeterminacy relations of nature. The Boltzmann constant (di-  
Ref. 269 vided by 2) thus fixes the smallest possible entropy value in nature. For this reason, Gilles  
Ref. 266 Cohen-Tannoudji calls it the *quantum of information* and Herbert Zimmermann calls it  
the *quantum of entropy*.

The relation (113) points towards a more general pattern. For every minimum value for  
an observable, there is a corresponding indeterminacy relation. We will come across this  
several times in the rest of our adventure, most importantly in the case of the quantum  
Vol. IV, page 13 of action and Heisenberg's indeterminacy relation.

The existence of a smallest entropy has numerous consequences. First of all, it sheds  
light on the third principle of thermodynamics. A smallest entropy implies that absolute  
zero temperature is not achievable. Secondly, a smallest entropy explains why entropy  
values are finite instead of infinite. Thirdly, it fixes the absolute value of entropy for ev-  
ery system; in continuum physics, entropy, like energy, is only defined up to an additive  
constant. The entropy limit settles all these issues.

The existence of a minimum value for an observable implies that an indeterminacy  
relation appears for any two quantities whose product yields that observable. For exam-  
ple, entropy production rate and time are such a pair. Indeed, an indeterminacy relation  
connects the entropy production rate  $P = dS/dt$  and the time  $t$ :

$$\Delta P \Delta t \geq \frac{k}{2}. \quad (114)$$

Ref. 269, Ref. 267 From this and the previous relation (113) it is possible to deduce all of statistical physics,  
i.e., the precise theory of thermostatics and thermodynamics. We will not explore this fur-  
ther here. (Can you show that the zeroth and third principle follows from the existence  
Challenge 568 ny of a smallest entropy?) We will limit ourselves to one of the cornerstones of thermody-  
namics: the second principle.

#### WHY CAN'T WE REMEMBER THE FUTURE?

“It's a poor sort of memory which only works  
backwards.”

Lewis Carroll, *Alice in Wonderland*

Page 38 When we first discussed time, we ignored the difference between past and future. But  
obviously, a difference exists, as we do not have the ability to remember the future. This  
is not a limitation of our brain alone. All the devices we have invented, such as tape  
recorders, photographic cameras, newspapers and books, only tell us about the past. Is  
there a way to build a video recorder with a 'future' button? Such a device would have to

Ref. 267 \* It seems that the historical value for the right hand side,  $k$ , has to be corrected to  $k/2$ , for the same reason  
that the quantum of action  $\hbar$  appears with a factor 1/2 in Heisenberg's indeterminacy relations.



TABLE 46 Some minimum flow values found in nature.

OBSERVATION	MINIMUM FLOW
Matter flow	one molecule or one atom or one particle
Volume flow	one molecule or one atom or one particle
Angular momentum flow	Planck's quantum of action
Chemical amount of substance	one molecule, one atom or one particle
Entropy flow	the minimum entropy
Charge flow	one elementary charge
Light flow	one single photon, Planck's quantum of action

Challenge 569 ny solve a deep problem: how would it distinguish between the near and the far future? It does not take much thought to see that any way to do this would conflict with the second principle of thermodynamics. That is unfortunate, as we would need precisely the same device to show that there is faster-than-light motion. Can you find the connection?

Challenge 570 ny In summary, the future cannot be remembered because entropy in closed systems tends towards a maximum. Put even more simply, memory exists because the brain is made of many particles, and so the brain is limited to the past. However, for the most simple types of motion, when only a few particles are involved, the difference between past and future disappears. For few-particle systems, there is no difference between times gone by and times approaching. We could say that the future differs from the past only in our brain, or equivalently, only because of friction. Therefore the difference between the past and the future is not mentioned frequently in this walk, even though it is an essential part of our human experience. But the fun of the present adventure is precisely to overcome our limitations.

### IS EVERYTHING MADE OF PARTICLES?

“ A physicist is the atom's way of knowing about atoms. ”  
George Wald

Ref. 270

Historically, the study of statistical mechanics has been of fundamental importance for physics. It provided the first demonstration that physical objects are made of interacting particles. The story of this topic is in fact a long chain of arguments showing that all the properties we ascribe to objects, such as size, stiffness, colour, mass density, magnetism, thermal or electrical conductivity, result from the interaction of the many particles they consist of. The discovery that *all objects are made of interacting particles* has often been called the main result of modern science.

Page 290 How was this discovery made? Table 42 listed the main extensive quantities used in physics. Extensive quantities are able to flow. It turns out that all flows in nature are *composed* of elementary processes, as shown in Table 46. We have seen that flows of mass, volume, charge, entropy and substance are composed. Later, quantum theory will show the same for flows of angular momentum and of the nuclear quantum numbers. *All flows are made of particles.*

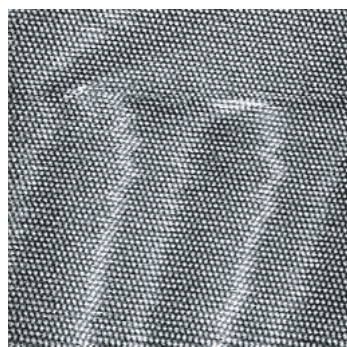


FIGURE 207 A 111 surface of a gold single crystal, every bright dot being an atom, with a surface dislocation (© CNRS).

Ref. 271

Challenge 571 ny

Vol. VI, page 97

This success of this idea has led many people to generalize it to the statement: ‘Everything we observe is made of parts.’ This approach has been applied with success to chemistry with molecules, materials science and geology with crystals, electricity with electrons, atoms with elementary particles, space with points, time with instants, light with photons, biology with cells, genetics with genes, neurology with neurons, mathematics with sets and relations, logic with elementary propositions, and even to linguistics with morphemes and phonemes. All these sciences have flourished on the idea that everything is made of related *parts*. The basic idea seems so self-evident that we find it difficult even to formulate an alternative. Just try!

However, in the case of the *whole* of nature, the idea that nature is a sum of related parts is incorrect. It turns out to be a prejudice, and a prejudice so entrenched that it retarded further developments in physics in the latter decades of the twentieth century. In particular, it does *not* apply to elementary particles or to space-time. Finding the correct description for the whole of nature is the biggest challenge of our adventure, as it requires a complete change in thinking habits. There is a lot of fun ahead.

“Jede Aussage über Komplexe läßt sich in eine Aussage über deren Bestandteile und in diejenigen Sätze zerlegen, welche die Komplexe vollständig beschreiben.\*”  
Ludwig Wittgenstein, *Tractatus*, 2.0201

#### WHY STONES CAN BE NEITHER SMOOTH NOR FRACTAL, NOR MADE OF LITTLE HARD BALLS

Page 303

The exploration of temperature yields another interesting result. Researchers first studied gases, and measured how much energy was needed to heat them by 1 K. The result is simple: all gases share only a few values, when the number of molecules  $N$  is taken into account. Monatomic gases (in a container with constant volume) require  $3Nk/2$ , diatomic gases (and those with a linear molecule)  $5Nk/2$ , and almost all other gases  $3Nk$ , where  $k = 1.4 \cdot 10^{-23}$  J/K is the Boltzmann constant.

The explanation of this result was soon forthcoming: each thermodynamic degree of

\* ‘Every statement about complexes can be resolved into a statement about their constituents and into the propositions that describe the complexes completely.’

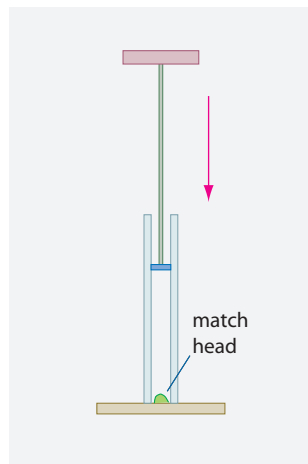


FIGURE 208 The fire pump.

freedom\* contributes the energy  $kT/2$  to the total energy, where  $T$  is the temperature. So the number of degrees of freedom in physical bodies is finite. Bodies are not continuous, nor are they fractals: if they were, their specific thermal energy would be infinite. Matter is indeed made of small basic entities.

All degrees of freedom contribute to the specific thermal energy. At least, this is what classical physics predicts. Solids, like stones, have 6 thermodynamic degrees of freedom and should show a specific thermal energy of  $3Nk$ . At high temperatures, this is indeed observed. But measurements of solids at room temperature yield lower values, and the lower the temperature, the lower the values become. Even gases show values lower than those just mentioned, when the temperature is sufficiently low. In other words, molecules and atoms behave differently at low energies: atoms are not immutable little hard balls. The deviation of these values is one of the first hints of quantum theory.

#### CURIOSITIES AND FUN CHALLENGES ABOUT HEAT AND REVERSIBILITY

Compression of air increases its temperature. This is shown directly by the fire pump, a variation of a bicycle pump, shown in Figure 208. (For a working example, see the website [www.tn.tudelft.nl/cdd](http://www.tn.tudelft.nl/cdd)). A match head at the bottom of an air pump made of transparent material is easily ignited by the compression of the air above it. The temperature of the air after compression is so high that the match head ignites spontaneously.

\* \*

Running backwards is an interesting sport. The 2006 world records for running backwards can be found on [www.recordholders.org/en/list/backwards-running.html](http://www.recordholders.org/en/list/backwards-running.html). You will be astonished how much these records are faster than your best personal *forward*-running time.

Challenge 572 e

\* A *thermodynamic degree of freedom* is, for each particle in a system, the number of dimensions in which it can move plus the number of dimensions in which it is kept in a potential. Atoms in a solid have six, particles in monatomic gases have only three; particles in diatomic gases or rigid linear molecules have five. The number of degrees of freedom of larger molecules depends on their shape.

Ref. 272

\* \*

If heat really is disordered motion of atoms, a big problem appears. When two atoms collide head-on, in the instant of smallest distance, neither atom has velocity. Where does the kinetic energy go? Obviously, it is transformed into potential energy. But that implies that atoms can be deformed, that they have internal structure, that they have parts, and thus that they can in principle be split. In short, if heat is disordered atomic motion, *atoms are not indivisible!* In the nineteenth century this argument was put forward in order to show that heat cannot be atomic motion, but must be some sort of fluid. But since we know that heat really is kinetic energy, atoms must indeed be divisible, even though their name means ‘indivisible’. We do not need an expensive experiment to show this.

\* \*

Ref. 273 How long does it take to cook an egg? This issue has been researched in many details; of course, the time depends on what type of egg you want, how large it is, and whether it comes from the fridge or not. There is even a formula for calculating the cooking time! Egg white starts hardening at 62°, the yolk starts hardening at 65°. The best-tasting hard eggs are formed at 69°, half-hard eggs at 65°, and soft eggs at 63°. If you cook eggs at 100° (for a long time), the white gets the consistency of rubber and the yolk gets a green surface that smells badly, because the high temperature leads to the formation of the smelly H<sub>2</sub>S, which then bonds to iron and forms the green FeS. Note that when temperature is controlled, the time plays no role; ‘cooking’ an egg at 65° for 10 minutes or 10 hours gives the *same* result.

\* \*

Challenge 573 s It is easy to cook an egg in such a way that the white is hard but the yolk remains liquid.  
Challenge 574 e Can you achieve the opposite? Research has even shown how you can cook an egg so that the yolk remains at the centre. Can you imagine the method?

\* \*

Ref. 274 In 1912, Emile Borel noted that if a gram of matter on Sirius was displaced by one centimetre, it would change the gravitational field on Earth by a tiny amount only. But this tiny change would be sufficient to make it impossible to calculate the path of molecules in a gas after a fraction of a second.

\* \*

Challenge 575 s Not only gases, but also most other materials expand when the temperature rises. As a result, the electrical wires supported by pylons hang much lower in summer than in winter. True?

\* \*

Ref. 275 The following is a famous problem asked by Fermi. Given that a human corpse cools  
Challenge 576 ny down in four hours after death, what is the minimum number of calories needed per day in our food?

\* \*

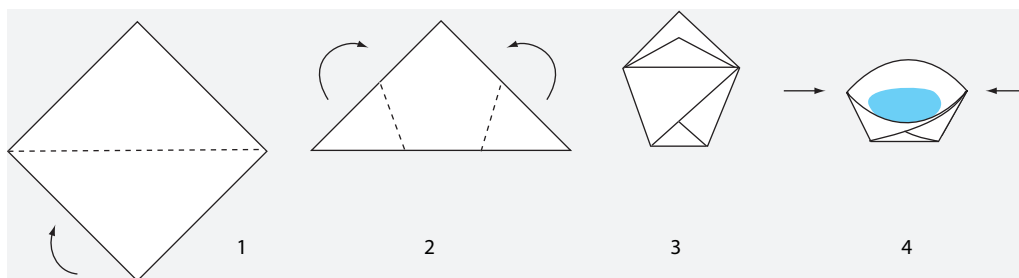


FIGURE 209 Can you boil water in this paper cup?

The energy contained in thermal motion is not negligible. A 1 g bullet travelling at the speed of sound has a kinetic energy of only 0.01 kcal.

\* \*

Challenge 577 s How does a typical,  $1500 \text{ m}^3$  hot-air balloon work?

\* \*

If you do not like this text, here is a proposal. You can use the paper to make a cup, as shown in Figure 209, and boil water in it over an open flame. However, to succeed, you have to be a little careful. Can you find out in what way?

Challenge 578 s

\* \*

Mixing 1 kg of water at  $0^\circ\text{C}$  and 1 kg of water at  $100^\circ\text{C}$  gives 2 kg of water at  $50^\circ\text{C}$ . What is the result of mixing 1 kg of *ice* at  $0^\circ\text{C}$  and 1 kg of water at  $100^\circ\text{C}$ ?

Challenge 579 ny

\* \*

Ref. 276 The highest recorded air temperature in which a man has survived is  $127^\circ\text{C}$ . This was tested in 1775 in London, by the secretary of the Royal Society, Charles Blagden, together with a few friends, who remained in a room at that temperature for 45 minutes. Interestingly, the raw steak which he had taken in with him was cooked ('well done') when he and his friends left the room. What condition had to be strictly met in order to avoid cooking the people in the same way as the steak?

Challenge 580 s

\* \*

Challenge 581 s Why does water boil at  $99.975^\circ\text{C}$  instead of  $100^\circ\text{C}$ ?

\* \*

Challenge 582 s Can you fill a bottle precisely with  $1 \pm 10^{-30}$  kg of water?

\* \*

One gram of fat, either butter or human fat, contains 38 kJ of chemical energy (or, in ancient units more familiar to nutritionists, 9 kcal). That is the same value as that of petrol.

Challenge 583 s

Why are people and butter less dangerous than petrol?

\* \*

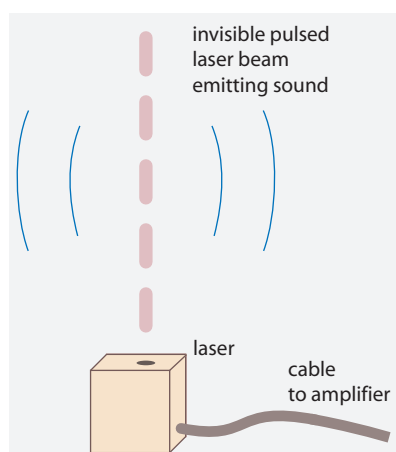


FIGURE 210 The invisible loudspeaker.

In 1992, the Dutch physicist Martin van der Mark invented a loudspeaker which works by heating air with a laser beam. He demonstrated that with the right wavelength and with a suitable modulation of the intensity, a laser beam in air can generate sound. The effect at the basis of this device, called the *photoacoustic effect*, appears in many materials. The best laser wavelength for air is in the infrared domain, on one of the few absorption lines of water vapour. In other words, a properly modulated infrared laser beam that shines through the air generates sound. Such light can be emitted from a small matchbox-sized semiconductor laser hidden in the ceiling and shining downwards. The sound is emitted in all directions perpendicular to the beam. Since infrared laser light is not visible, Martin van der Mark thus invented an invisible loudspeaker! Unfortunately, the efficiency of present versions is still low, so that the power of the speaker is not yet sufficient for practical applications. Progress in laser technology should change this, so that in the future we should be able to hear sound that is emitted from the centre of an otherwise empty room.

\* \*

A famous exam question: How can you measure the height of a building with a barometer, a rope and a ruler? Find at least six different ways.

Challenge 584 s

\* \*

What is the approximate probability that out of one million throws of a coin you get exactly 500 000 heads and as many tails? You may want to use Stirling's formula  $n! \approx \sqrt{2\pi n} (n/e)^n$  to calculate the result.\*

Challenge 585 ny

\* \*

Does it make sense to talk about the entropy of the universe?

Challenge 586 s

\* \*

\* There are many improvements to Stirling's formula. A simple one is Gosper's formula  $n! \approx \sqrt{(2n + 1/3)\pi} (n/e)^n$ . Another is  $\sqrt{2\pi n} (n/e)^n e^{1/(12n+1)} < n! < \sqrt{2\pi n} (n/e)^n e^{1/(12n)}$ .

Challenge 587 ny Can a helium balloon lift the tank which filled it?

\* \*

All friction processes, such as osmosis, diffusion, evaporation, or decay, are *slow*. They take a characteristic time. It turns out that any (macroscopic) process with a time-scale is irreversible. This is no real surprise: we know intuitively that undoing things always takes more time than doing them. That is again the second principle of thermodynamics.

\* \*

Ref. 277 It turns out that *storing* information is possible with negligible entropy generation. However, *erasing* information requires entropy. This is the main reason why computers, as well as brains, require energy sources and cooling systems, even if their mechanisms would otherwise need no energy at all.

\* \*

Challenge 588 ny When mixing hot rum and cold water, how does the increase in entropy due to the mixing compare with the entropy increase due to the temperature difference?

\* \*

Challenge 589 s Why aren't there any small humans, say 10 mm in size, as in many fairy tales? In fact, there are no warm-blooded animals of that size at all. Why not?

\* \*

Shining a light onto a body and repeatedly switching it on and off produces sound. This is called the *photoacoustic effect*, and is due to the thermal expansion of the material. By changing the frequency of the light, and measuring the intensity of the noise, one reveals a characteristic photoacoustic spectrum for the material. This method allows us to detect gas concentrations in air of one part in  $10^9$ . It is used, among other methods, to study the gases emitted by plants. Plants emit methane, alcohol and acetaldehyde in small quantities; the photoacoustic effect can detect these gases and help us to understand the processes behind their emission.

\* \*

Challenge 590 ny What is the rough probability that all oxygen molecules in the air would move away from a given city for a few minutes, killing all inhabitants?

\* \*

Challenge 591 ny If you pour a litre of water into the sea, stir thoroughly through all the oceans and then take out a litre of the mixture, how many of the original atoms will you find?

\* \*

Challenge 592 ny How long would you go on breathing in the room you are in if it were airtight?

\* \*

Challenge 593 ny What happens if you put some ash onto a piece of sugar and set fire to the whole? (Warning: this is dangerous and not for kids.)



\* \*

Entropy calculations are often surprising. For a system of  $N$  particles with two states each, there are  $W_{\text{all}} = 2^N$  states. For its most probable configuration, with exactly half the particles in one state, and the other half in the other state, we have  $W_{\text{max}} = N!/((N/2)!)^2$ . Now, for a macroscopic system of particles, we might typically have  $N = 10^{24}$ . That gives  $W_{\text{all}} \gg W_{\text{max}}$ ; indeed, the former is  $10^{12}$  times larger than the latter. On the other hand, we find that  $\ln W_{\text{all}}$  and  $\ln W_{\text{max}}$  agree for the first 20 digits! Even though the configuration with exactly half the particles in each state is much more rare than the general case, where the ratio is allowed to vary, the entropy turns out to be the same. Why?

Challenge 594 ny

Challenge 595 ny

\* \*

If heat is due to motion of atoms, our built-in senses of heat and cold are simply detectors of motion. How could they work?

Challenge 596 ny

By the way, the senses of smell and taste can also be seen as motion detectors, as they signal the presence of molecules flying around in air or in liquids. Do you agree?

Challenge 597 ny

\* \*

The Moon has an atmosphere, although an extremely thin one, consisting of sodium (Na) and potassium (K). This atmosphere has been detected up to nine Moon radii from its surface. The atmosphere of the Moon is generated at the surface by the ultraviolet radiation from the Sun. Can you estimate the Moon's atmospheric density?

Challenge 598 s

\* \*

Does it make sense to add a line in [Table 42](#) for the quantity of physical action? A column? Why?

Challenge 599 ny

\* \*

Diffusion provides a length scale. For example, insects take in oxygen through their skin. As a result, the interiors of their bodies cannot be much more distant from the surface than about a centimetre. Can you list some other length scales in nature implied by diffusion processes?

Challenge 600 s

\* \*

Rising warm air is the reason why many insects are found in tall clouds in the evening. Many insects, especially that seek out blood in animals, are attracted to warm and humid air.

\* \*

Thermometers based on mercury can reach  $750^\circ\text{C}$ . How is this possible, given that mercury boils at  $357^\circ\text{C}$ ?

Challenge 601 s

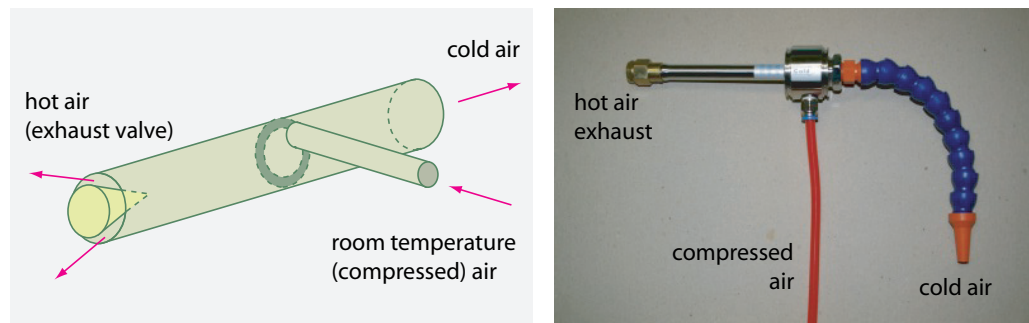
\* \*

What does a burning candle look like in weightless conditions?

Challenge 602 s

\* \*

It is possible to build a power station by building a large chimney, so that air heated by



**FIGURE 211** The design of the Wirbelrohr or Ranque–Hilsch vortex tube, and a commercial version, about 40 cm in size, used to cool manufacturing processes (© Coolquip).

the Sun flows upwards in it, driving a turbine as it does so. It is also possible to make a power station by building a long vertical tube, and letting a gas such as ammonia rise into it which is then liquefied at the top by the low temperatures in the upper atmosphere; as it falls back down a second tube as a liquid – just like rain – it drives a turbine. Why are such schemes, which are almost completely non-polluting, not used yet?

Challenge 603 s

\* \*

One of the most surprising devices ever invented is the *Wirbelrohr* or Ranque–Hilsch vortex tube. By blowing compressed air at room temperature into it at its midpoint, two flows of air are formed at its ends. One is extremely cold, easily as low as  $-50^{\circ}\text{C}$ , and one extremely hot, up to  $200^{\circ}\text{C}$ . No moving parts and no heating devices are found inside. How does it work?

Challenge 604 s

\* \*

Thermoacoustic engines, pumps and refrigerators provide many strange and fascinating applications of heat. For example, it is possible to use loud sound in closed metal chambers to move heat from a cold place to a hot one. Such devices have few moving parts and are being studied in the hope of finding practical applications in the future.

Ref. 278

\* \*

Challenge 605 ny Does a closed few-particle system contradict the second principle of thermodynamics?

\* \*

What happens to entropy when gravitation is taken into account? We carefully left gravitation out of our discussion. In fact, gravitation leads to many new problems – just try to think about the issue. For example, Jacob Bekenstein has discovered that matter reaches its highest possible entropy when it forms a black hole. Can you confirm this?

Challenge 606 ny

\* \*

The numerical values (but not the units!) of the Boltzmann constant  $k = 1.38 \cdot 10^{-23} \text{ J/K}$  and the combination  $h/ce$  agree in their exponent and in their first three digits, where  $h$  is Planck's constant and  $e$  is the electron charge. Can you dismiss this as mere coincidence?

Challenge 607 ny

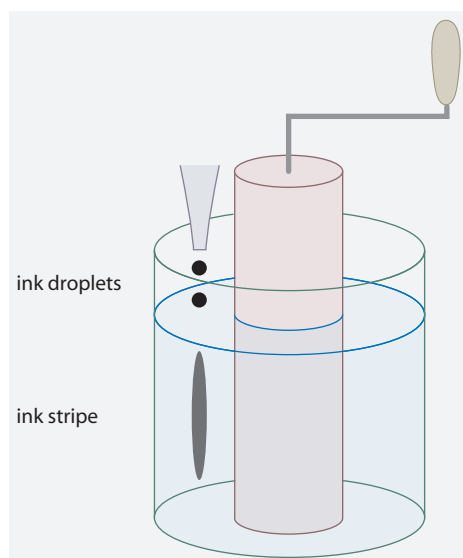


FIGURE 212 What happens to the ink stripe if the inner cylinder is turned a few times in one direction, and then turned back by the same amount?

\* \*

Mixing is not always easy to perform. The experiment of Figure 212 gives completely different results with water and glycerine. Can you guess them?

Challenge 608 s

\* \*

There are less-well known arguments about atoms. In fact, two everyday prove the existence of atoms: sex and memory. Why?

Challenge 609 ny

In the context of lasers and of spin systems, it is fun to talk about negative temperature.

Challenge 610 s

Why is this not really sensible?

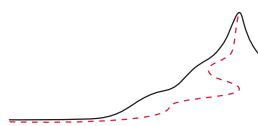
### SUMMARY ON HEAT AND TIME-INVARIANCE

Microscopic motion due to gravity and electric interactions, thus all microscopic motion in everyday life, is *reversible*: such motion can occur backwards in time. In other words, motion due to gravity and electromagnetism is time-reversal-invariant or motion-reversal-invariant.

Nevertheless, everyday motion is *irreversible*, because there are no completely closed systems in everyday life. Equivalently, irreversibility results from the extremely low probabilities required to perform a motion inversion. Macroscopic irreversibility does not contradict microscopic reversibility.

For these reasons, in everyday life, entropy in closed systems always increases. This leads to a famous issue: how can evolution be reconciled with entropy increase? Let us have a look.





# SELF-ORGANIZATION AND CHAOS – THE SIMPLICITY OF COMPLEXITY

“To speak of non-linear physics is like calling zoology the study of non-elephant animals.”  
Stanislaw Ulam

Ref. 279

In our list of global descriptions of motion, the high point is the study of self-organization. Self-organization is the appearance of order. *Order* is a term that includes *shapes*, such as the complex symmetry of snowflakes; *patterns*, such as the stripes of zebras; and *cycles*, such as the creation of sound when singing. Indeed, every example of what we call *beauty* is a combination of shapes, patterns and cycles. (Do you agree?) Self-organization can thus be called the study of the origin of beauty.

Ref. 280

Challenge 611 s

The appearance of order is a general observation across nature. Fluids in particular exhibit many phenomena where order appears and disappears. Examples include the more or less regular flickering of a burning candle, the flapping of a flag in the wind, the regular stream of bubbles emerging from small irregularities in the surface of a champagne glass, and the regular or irregular dripping of a water tap.

The appearance of order is found from the cell differentiation in an embryo inside a woman's body; the formation of colour patterns on tigers, tropical fish and butterflies; the symmetrical arrangements of flower petals; the formation of biological rhythms; and so on.

Vol. III, page 166

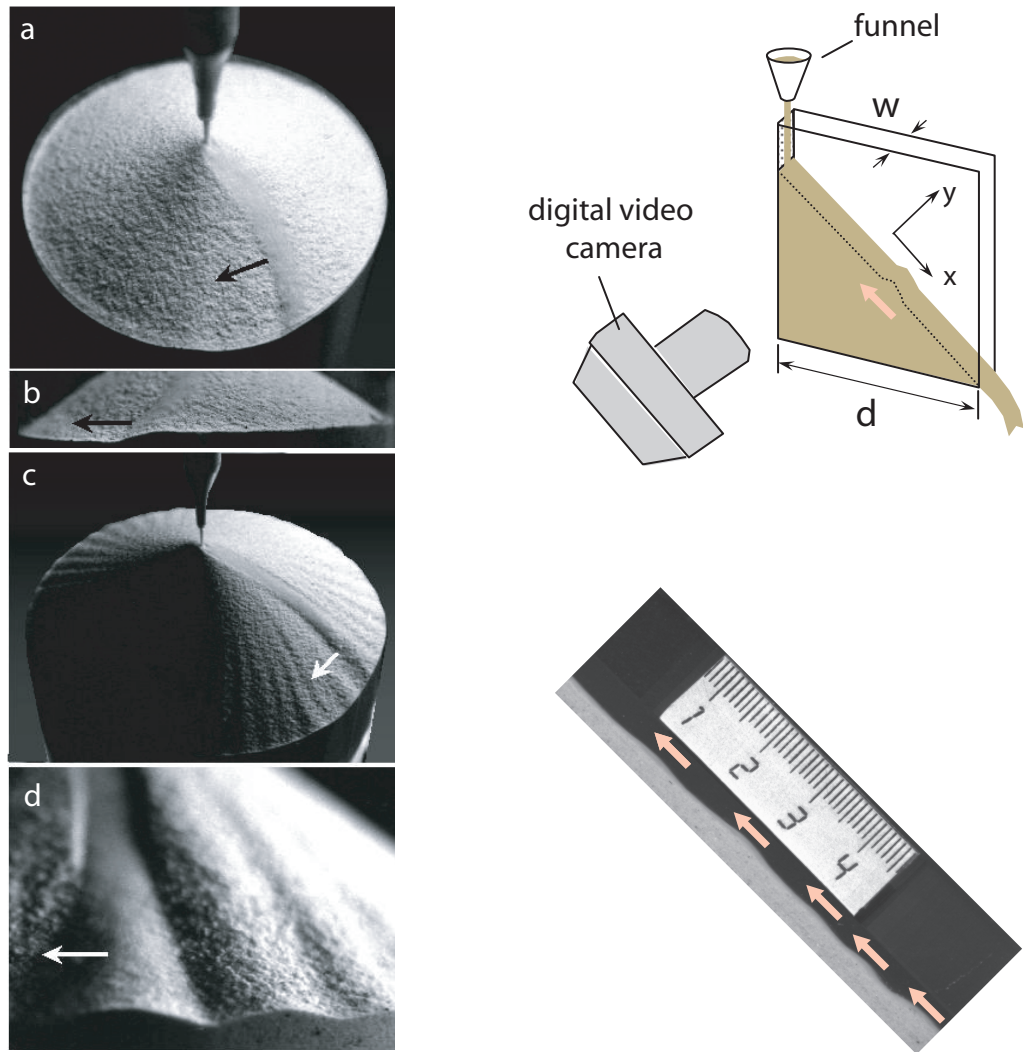
All growth processes are self-organization phenomena. Have you ever pondered the incredible way in which teeth grow? A practically inorganic material forms shapes in the upper and the lower rows fitting exactly into each other. How this process is controlled is still a topic of research. Also the formation, before and after birth, of neural networks in the brain is another process of self-organization. Even the physical processes at the basis of thinking, involving changing electrical signals, is to be described in terms of self-organization.

Ref. 281

Vol. III, page 299

Biological evolution is a special case of growth. Take the evolution of animal shapes. It turns out that snake tongues are forked because that is the most efficient shape for following chemical trails left by prey and other snakes of the same species. (Snakes smell with the help of their tongue.) The fixed numbers of fingers in human hands or of petals of flowers are also consequences of self-organization.

Many problems of self-organization are mechanical problems: for example, the formation of mountain ranges when continents move, the creation of earthquakes, or the creation of regular cloud arrangements in the sky. It can be fascinating to ponder, during an otherwise boring flight, the mechanisms behind the formation of the clouds you see



**FIGURE 213** Examples of self-organization for sand: spontaneous appearance of a temporal cycle (a and b), spontaneous appearance of a periodic pattern (b and c), spontaneous appearance of a spatiotemporal pattern, namely solitary waves (right) (© Ernesto Altshuler et al.).

Challenge 612 e from the aeroplane.

Studies into the conditions required for the appearance or disappearance of order have shown that their description requires only a few common concepts, independently of the details of the physical system. This is best seen looking at a few examples.

All the richness of self-organization reveals itself in the study of plain sand. Why do sand dunes have ripples, as does the sand floor at the bottom of the sea? We can also study how avalanches occur on steep heaps of sand and how sand behaves in hour-glasses, in mixers, or in vibrating containers. The results are often surprising. For example, as recently as 2006, the Cuban research group of Ernesto Altshuler and his colleagues discovered solitary waves on sand flows (shown in Figure 213). They had already discov-

Ref. 282

TABLE 47 Patterns on horizontal sand and sand-like surfaces in the sea and on land.

PATTERN	PERIOD	AMPLITUDE	ORIGIN
<b>Under water</b>			
Ribbles	5 cm	5 mm	water waves
Megaribbles	1 m	0.1 m	tides
Sand waves	100 to 800 m	5 m	tides
Sand banks	2 to 10 km	2 to 20 m	tides
<b>In air</b>			
Ribbles	0.1 m	0.05 m	wind
Singing sand	95 to 105 Hz	up to 105 dB	wind on sand dunes, avalanches making the dune vibrate
Road corrugations	0.3 to 0.9 m	0.05 m	wheels
Ski moguls	5 to 6 m	up to 1 m	skiers
<b>Elsewhere</b>			
On Mars	a few km	few tens of m	wind



FIGURE 214 Road corrugations (courtesy David Mays).

ered the revolving river effect on sand piles, shown in the same figure, in 2002. Even more surprisingly, these effects occur only for Cuban sand, and a few rare other types of sand. The reasons are still unclear.

Ref. 283

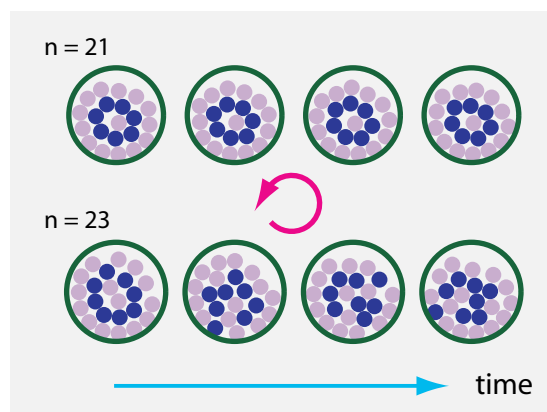
Similarly, in 1996 Paul Umbanhowar and his colleagues found that when a flat container holding tiny bronze balls (around 0.165 mm in diameter) is shaken up and down in vacuum at certain frequencies, the surface of this bronze 'sand' forms stable heaps. They are shown in Figure 215. These heaps, so-called *oscillons*, also bob up and down. Oscillons can move and interact with one another.

Oscillons in sand are a simple example for a general effect in nature: *discrete* systems





**FIGURE 215** Oscillons formed by shaken bronze balls; horizontal size is about 2 cm (© Paul Umbanhowar)



**FIGURE 216** Magic numbers: 21 spheres, when swirled in a dish, behave differently from non-magic numbers, like 23, of spheres (redrawn from photographs © Karsten Kötter).

Ref. 284

with nonlinear interactions can exhibit localized excitations. This fascinating topic is just beginning to be researched. It might well be that it will yield results relevant to our understanding of elementary particles.

Ref. 285

Ref. 286

Challenge 613 s

Page 253

Ref. 287

Sand shows many other pattern-forming processes. A mixture of sand and sugar, when poured onto a heap, forms regular layered structures that in cross section look like zebra stripes. Horizontally rotating cylinders with binary mixtures inside them separate the mixture out over time. Or take a container with two compartments separated by a 1 cm wall. Fill both halves with sand and rapidly shake the whole container with a machine. Over time, all the sand will spontaneously accumulate in one half of the container. As another example of self-organization in sand, people have studied the various types of sand dunes that 'sing' when the wind blows over them. Also the corrugations formed by traffic on roads without tarmac, the washboard roads shown in [Figure 214](#), are an example of self-organization. These corrugation patterns move, over time, *against* the traffic direction. Can you explain why? The moving ski moguls mentioned above also belong here. In fact, the behaviour of sand and dust is proving to be such a beautiful and fascinating topic that the prospect of each human returning dust does not look so grim after all.

Another simple and beautiful example of self-organization is the effect discovered in 1999 by Karsten Kötter and his group. They found that the behaviour of a set of spheres swirled in a dish depends on the number of spheres used. Usually, all the spheres get continuously mixed up. But for certain 'magic' numbers, such as 21, stable ring patterns emerge, for which the outside spheres remain outside and the inside ones remain inside. The rings, best seen by colouring the spheres, are shown in [Figure 216](#).

These and many other studies of self-organizing systems have changed our under-





**FIGURE 217** Self-organization: a growing snowflake (QuickTime film © Kenneth Libbrecht)

Ref. 288

standing of nature in a number of ways. First of all, they have shown that patterns and shapes are similar to cycles: all are due to motion. Without motion, and thus without history, there is no order, neither patterns nor shapes. Every pattern has a history; every pattern is a result of motion. An example is shown in [Figure 217](#).

Secondly, patterns, shapes and cycles are due to the organized motion of large numbers of small constituents. Systems which self-organize are always composite: they are *cooperative structures*.

Thirdly, all these systems obey evolution equations which are *nonlinear* in the configuration variables. Linear systems do not self-organize. Many self-organizing systems also show *chaotic* motion.

Fourthly, the appearance and disappearance of order depends on the strength of a driving force, the so-called *order parameter*. Often, chaotic motion appears when the driving is increased beyond the value necessary for the appearance of order. An example of chaotic motion is turbulence, which appears when the order parameter, which is proportional to the speed of the fluid, is increased to high values.

Moreover, all order and all structure appears when two general types of motion compete with each other, namely a 'driving', energy-adding process, and a 'dissipating', braking mechanism. Thermodynamics plays a role in all self-organization. Self-organizing systems are always *dissipative systems*, and are always far from equilibrium. When the driving and the dissipation are of the same order of magnitude, and when the key behaviour of the system is not a linear function of the driving action, order may appear.\*

All self-organizing systems at the onset of order appearance can be described by equa-

---

\* To describe the 'mystery' of human life, terms like 'fire', 'river' or 'tree' are often used as analogies. These are all examples of self-organized systems: they have many degrees of freedom, have competing driving and braking forces, depend critically on their initial conditions, show chaos and irregular behaviour, and sometimes show cycles and regular behaviour. Humans and human life resemble them in all these respects; thus there is a solid basis to their use as metaphors. We could even go further and speculate that pure beauty is pure self-organization. The lack of beauty indeed often results from a disturbed equilibrium between external braking and external driving.

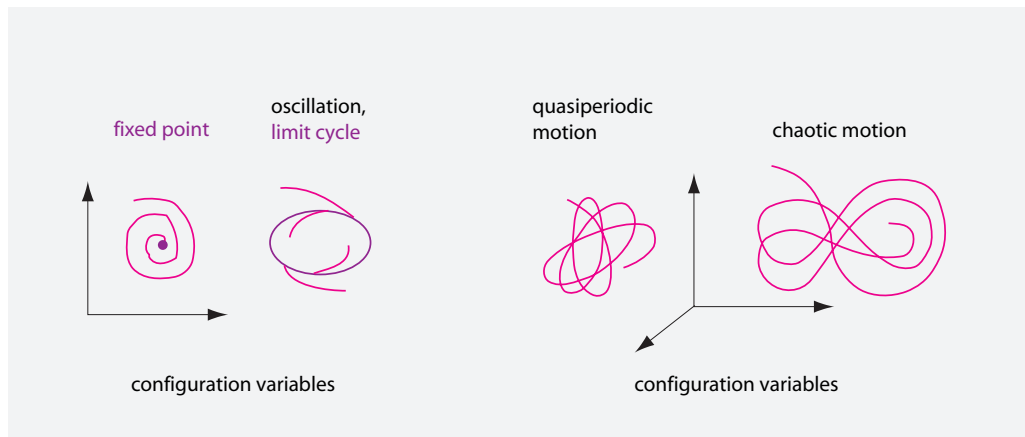


FIGURE 218 Examples of different types of motion in configuration space.

tions for the pattern amplitude  $A$  of the general form

$$\frac{\partial A(t, x)}{\partial t} = \lambda A - \mu |A|^2 A + \kappa \Delta A + \text{higher orders} . \tag{115}$$

Here, the – possibly complex – observable  $A$  is the one that appears when order appears, such as the oscillation amplitude or the pattern amplitude. The first term  $\lambda A$  is the driving term, in which  $\lambda$  is a parameter describing the strength of the driving. The next term is a typical nonlinearity in  $A$ , with  $\mu$  a parameter that describes its strength, and the third term  $\kappa \Delta A = \kappa (\partial^2 A / \partial x^2 + \partial^2 A / \partial y^2 + \partial^2 A / \partial z^2)$  is a typical diffusive and thus dissipative term.

Challenge 614 ny

Challenge 615 ny

One can distinguish two main situations. In cases where the dissipative term plays no role ( $\kappa = 0$ ), one finds that when the driving parameter  $\lambda$  increases above zero, a *temporal* oscillation appears, i.e., a stable cycle with non-vanishing amplitude. In cases where the diffusive term does play a role, equation (115) describes how an amplitude for a *spatial* oscillation appears when the driving parameter  $\lambda$  becomes positive, as the solution  $A = 0$  then becomes spatially unstable.

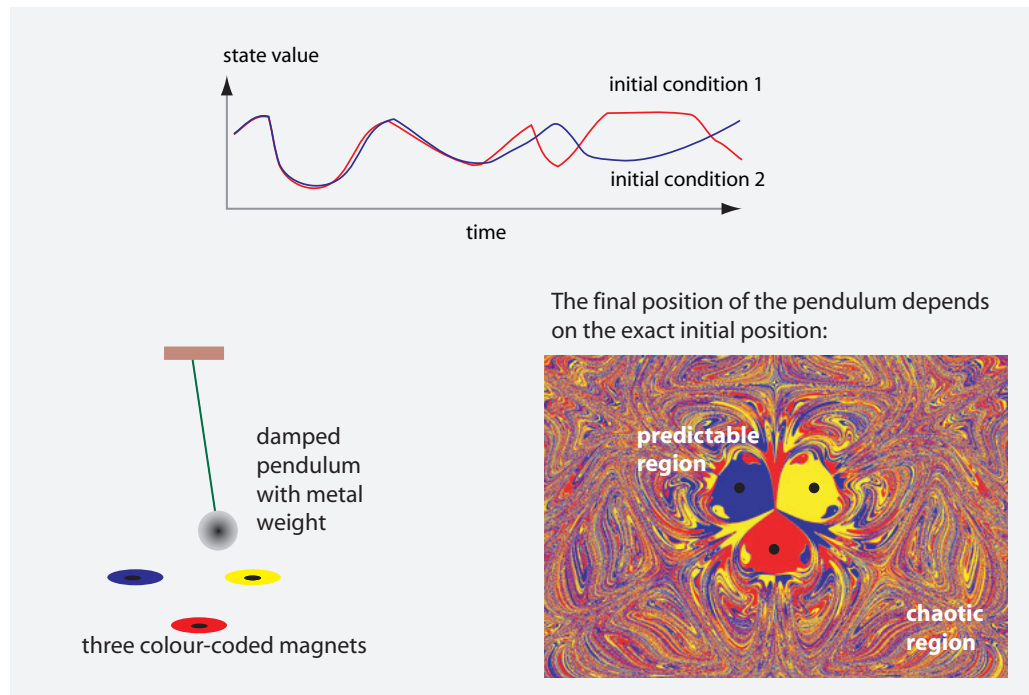
Ref. 289

In both cases, the onset of order is called a *bifurcation*, because at this critical value of the driving parameter  $\lambda$  the situation with amplitude zero, i.e., the homogeneous (or un-ordered) state, becomes unstable, and the ordered state becomes stable. *In nonlinear systems, order is stable.* This is the main conceptual result of the field. Equation (115) and its numerous variations allow us to describe many phenomena, ranging from spirals, waves, hexagonal patterns, and topological defects, to some forms of turbulence. For every physical system under study, the main task is to distil the observable  $A$  and the parameters  $\lambda$ ,  $\mu$  and  $\kappa$  from the underlying physical processes.

Challenge 616 ny

Self-organization is a vast field which is yielding new results almost by the week. To discover new topics of study, it is often sufficient to keep one’s eye open; most effects are comprehensible without advanced mathematics. Good hunting!

Most systems that show self-organization also show another type of motion. When the driving parameter of a self-organizing system is increased to higher and higher val-



**FIGURE 219** Chaos as sensitivity to initial conditions: the general case, and a simple chaotic system: a metal pendulum over three magnets (fractal © Paul Nylander).

ues, order becomes more and more irregular, and in the end one usually finds chaos. For physicists, chaotic motion is the most irregular type of motion.\* Chaos can be defined independently of self-organization, namely as that motion of systems for which small changes in initial conditions evolve into large changes of the motion (exponentially with time), as shown in Figure 219. More precisely, *chaos* is irregular motion characterized by a positive *Lyapunov exponent* in the presence of a strictly valid evolution.

A simple chaotic system is the damped pendulum above three magnets. Figure 219 shows how regions of predictability (around the three magnet positions) gradually change to region of unpredictability, for higher initial amplitudes. The weather is also a chaotic system, as are dripping water-taps, the fall of dice, and many other everyday systems. For example, research on the mechanisms by which the heart beat is generated has shown that the heart is not an oscillator, but a chaotic system with irregular cycles. This allows the heart to be continuously ready for demands for changes in beat rate which arise once the body needs to increase or decrease its efforts.

Ref. 290

Challenge 617 s

Incidentally, can you give a simple argument to show that the so-called *butterfly effect* does not exist? This 'effect' is often cited in newspapers. The claim is that nonlinearities imply that a small change in initial conditions can lead to large effects; thus a butterfly

\* On the topic of chaos, see the beautiful book by H. -O. PEITGEN, H. JÜRGENS & D. SAUPE, *Chaos and Fractals*, Springer Verlag, 1992. It includes stunning pictures, the necessary mathematical background, and some computer programs allowing personal exploration of the topic. 'Chaos' is an old word: according to Greek mythology, the first goddess, Gaia, i.e., the Earth, emerged from the chaos existing at the beginning. She then gave birth to the other gods, the animals and the first humans.

wing beat is alleged to be able to induce a tornado. Even though nonlinearities do indeed lead to growth of disturbances, the butterfly ‘effect’ has *never* been observed. Thus it does *not* exist. This ‘effect’ exists only to sell books and to get funding.

Challenge 618 ny

There is chaotic motion also in machines: chaos appears in the motion of trains on the rails, in gear mechanisms, and in fire-fighter’s hoses. The precise study of the motion in a zippo cigarette lighter will probably also yield an example of chaos. The mathematical description of chaos – simple for some textbook examples, but extremely involved for others – remains an important topic of research.

Ref. 291

All the steps from disorder to order, quasiperiodicity and finally to chaos, are examples of self-organization. These types of motion, illustrated in [Figure 218](#), are observed in many fluid systems. Their study should lead, one day, to a deeper understanding of the mysteries of turbulence. Despite the fascination of this topic, we will not explore it further, because it does not lead towards the top of Motion Mountain.

But self-organization is of interest also for a more general reason. It is sometimes said that our ability to formulate the patterns or rules of nature from observation does not imply the ability to predict *all* observations from these rules. According to this view, so-called ‘emergent’ properties exist, i.e., properties appearing in complex systems as something *new* that cannot be deduced from the properties of their parts and their interactions. (The ideological backdrop to this view is obvious; it is the last attempt to fight the determinism.) The study of self-organization has definitely settled this debate. The properties of water molecules do allow us to predict Niagara Falls.\* Similarly, the diffusion of signal molecules do determine the development of a single cell into a full human being: in particular, cooperative phenomena determine the places where arms and legs are formed; they ensure the (approximate) right–left symmetry of human bodies, prevent mix-ups of connections when the cells in the retina are wired to the brain, and explain the fur patterns on zebras and leopards, to cite only a few examples. Similarly, the mechanisms at the origin of the heart beat and many other cycles have been deciphered.

Ref. 293

Challenge 620 ny

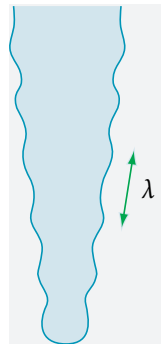
Self-organization provides general principles which allow us in principle to predict the behaviour of complex systems of any kind. They are presently being applied to the most complex system in the known universe: the human brain. The details of how it learns to coordinate the motion of the body, and how it extracts information from the images in the eye, are being studied intensely. The ongoing work in this domain is fascinating. (A neglected case of self-organization is *humour*.) If you plan to become a scientist, consider taking this path.

Self-organization research provided the final arguments that confirmed what J. Offrey de la Mettrie stated and explored in his famous book *L’homme machine* in 1748: humans are complex machines. Indeed, the lack of understanding of complex systems in the past was due mainly to the restrictive teaching of the subject of motion, which usually concentrated – as we do in this walk – on examples of motion in *simple* systems. The concepts of self-organization allow us to understand and to describe what happens during the functioning and the growth of organisms.

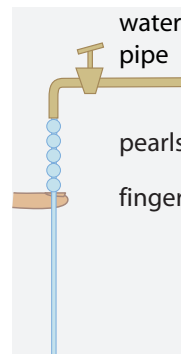
Ref. 292  
Challenge 619 ny

---

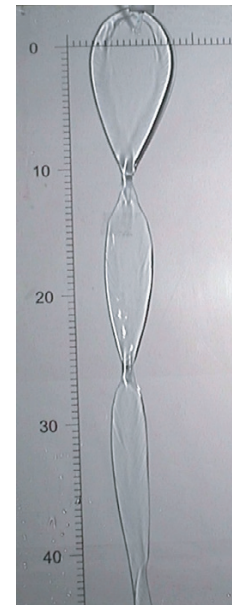
\* Already small versions of Niagara Falls, namely dripping water taps, show a large range of cooperative phenomena, including the chaotic, i.e., non-periodic, fall of water drops. This happens when the water flow has the correct value, as you can verify in your own kitchen. Several cooperative fluid phenomena have been simulated even on the molecular level.



**FIGURE 220**  
The wavy surface of icicles.



**FIGURE 221**  
Water pearls.



**FIGURE 222** A braiding water stream (© Vakhtang Putkaradze).

Even though the subject of self-organization provides fascinating insights, and will do so for many years to come, we now leave it. We continue with our own adventure, namely to explore the *basics* of motion.

“ Ich sage euch: man muss noch Chaos in sich haben, um einen tanzenden Stern gebären zu können. Ich sage euch: ihr habt noch Chaos in euch. ”  
Friedrich Nietzsche, *Also sprach Zarathustra*.

### CURIOSITIES AND FUN CHALLENGES ABOUT SELF-ORGANIZATION

Ref. 294

Challenge 621 ny

All icicles have a wavy surface, with a crest-to-crest distance of about 1 cm, as shown in **Figure 220**. The distance is determined by the interplay between water flow and surface cooling. How? (Indeed, stalagmites do not show the effect.)

\* \*

Challenge 622 ny

When wine is made to swirl in a wine glass, after the motion has calmed down, the wine flowing down the glass walls forms little arcs. Can you explain in a few words what forms them?

\* \*

Challenge 623 ny

How does the average distance between cars parked along a street change over time, assuming a constant rate of cars leaving and arriving?



**FIGURE 223** The Belousov-Zhabotinski reaction: the liquid periodically changes colour, both in space and time (© Yamaguchi University).

\* \*

Challenge 624 ny When a fine stream of water leaves a water tap, putting a finger in the stream leads to a wavy shape, as shown in [Figure 221](#). Why?

\* \*

Ref. 295 When water emerges from an oblong opening, the stream forms a braid pattern, as shown in [Figure 222](#). This effect results from the interplay and competition between inertia and surface tension: inertia tends to widen the stream, while surface tension tends to narrow it. Predicting the distance from one narrow region to the next is still a topic of research.

Challenge 625 e If the experiment is done in free air, without a plate, one usually observes an additional effect: there is a *chiral* braiding at the narrow regions, induced by the asymmetries of the water flow. You can observe this effect in the toilet! Scientific curiosity knows no limits: are you a right-turner or a left-turner, or both? On every day?

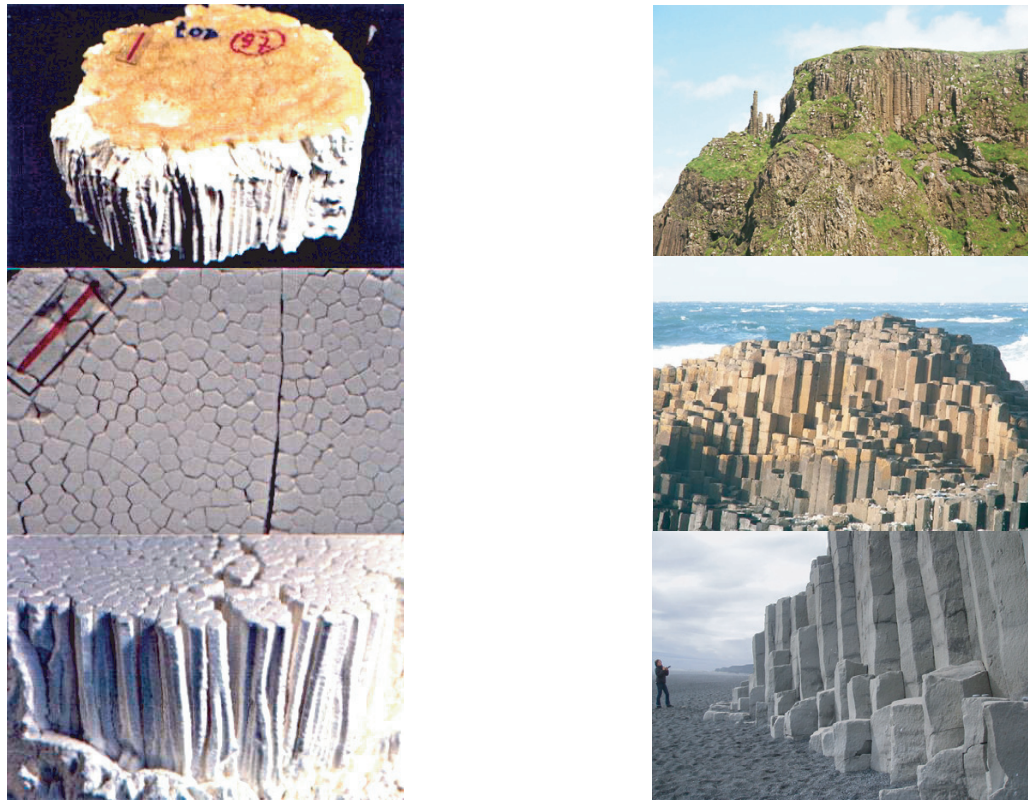
\* \*

A famous case of order appearance is the *Belousov-Zhabotinski reaction*. This mixture of chemicals spontaneously produces spatial and temporal patterns. Thin layers produce slowly rotating spiral patterns, as shown in [Figure 223](#); Large, stirred volumes oscillate back and forth between two colours. A beautiful movie of the oscillations can be found on [www.uni-r.de/Fakultaeten/nat\\_Fak\\_IV/Organische\\_Chemie/Didaktik/Keusch/D-oscill-d.htm](http://www.uni-r.de/Fakultaeten/nat_Fak_IV/Organische_Chemie/Didaktik/Keusch/D-oscill-d.htm). The exploration of this reaction led to the Nobel Prize in Chemistry for Ilya Prigogine in 1997.

\* \*

Ref. 296 Challenge 626 e Gerhard Müller has discovered a simple but beautiful way to observe self-organization in solids. His system also provides a model for a famous geological process, the formation of hexagonal columns in basalt, such as the Giant's Causeway in Northern Ireland. Similar formations are found in many other places of the Earth. Just take some rice flour or corn starch, mix it with about half the same amount of water, put the mixture into a pan and dry it with a lamp: hexagonal columns form. The analogy with basalt structures is possible because the drying of starch and the cooling of lava are diffusive processes





**FIGURE 224** A famous correspondence: on the left, hexagonal columns in starch, grown in a kitchen pan (the red lines are 1 cm in length), and on the right, hexagonal columns in basalt, grown from lava in Northern Ireland (top right, view of around 300 m, and middle right, view of around 40 m) and in Iceland (view of about 30 m, bottom right) (© Gerhard Müller, Raphael Kessler - [www.raphaelk.co.uk](http://www.raphaelk.co.uk), Bob Pohlrad, and Cédric Hüsler).

governed by the same equations, because the boundary conditions are the same, and because both materials respond to cooling with a small reduction in volume.

\* \*

Water flow in pipes can be laminar (smooth) or turbulent (irregular and disordered). The transition depends on the diameter  $d$  of the pipe and the speed  $v$  of the water. The transition usually happens when the so-called *Reynolds number* – defined as  $R = vd/\eta$  ( $\eta$  being the kinematic viscosity of the water, around  $1 \text{ mm}^2/\text{s}$ ) – becomes greater than about 2000. However, careful experiments show that with proper handling, laminar flows can be produced up to  $R = 100\,000$ . A linear analysis of the equations of motion of the fluid, the Navier–Stokes equations, even predicts stability of laminar flow for *all* Reynolds numbers. This riddle was solved only in the years 2003 and 2004. First, a complex mathematical analysis showed that the laminar flow is not always stable, and that the transition to turbulence in a long pipe occurs with travelling waves. Then, in 2004, careful experiments showed that these travelling waves indeed appear when water is flowing through a pipe at large Reynolds numbers.

Ref. 297



\* \*

For more beautiful pictures on self-organization in fluids, see the mentioned [serve.me.nus.edu.sg/limtt](http://serve.me.nus.edu.sg/limtt) website.

\* \*

Also *dance* is an example of self-organization. Self-organization takes part in the brain. Like for all complex movements, learning them is often a challenge. Nowadays there are beautiful books that tell how physics can help you improve your dancing skills and the grace of your movements.

Ref. 298

\* \*

Do you want to enjoy working on your PhD? Go into a scientific toy shop, and look for a toy that moves in a complex way. There are high chances that the motion is chaotic; explore the motion and present a thesis about it. For example, go to the extreme: explore the motion of a hanging rope whose upper end is externally driven. The system is fascinating.

\* \*

Self-organization is also observed in liquid corn starch–water mixtures. Enjoy the film at [www.youtube.org/watch?v=f2XQ97XHjVw](http://www.youtube.org/watch?v=f2XQ97XHjVw) and watch even more bizarre effects, for humans walking over a pool filled with the liquid, on [www.youtube.org/watch?v=nq3ZjY0Uf-g](http://www.youtube.org/watch?v=nq3ZjY0Uf-g).

\* \*

A famous example of self-organization whose mechanisms are not well-known so far, is the *hiccup*. It is known that the vagus nerve plays a role in it. Like for many other examples of self-organization, it takes quite some energy to get rid of a hiccup. Modern experimental research has shown that orgasms, which strongly stimulate the vagus nerve, are excellent ways to overcome hiccups. One of these researchers has won the 2006 IgNobel Prize for medicine for his work.

\* \*

Another important example of self-organization is the *weather*. If you want to know more about the known connections between the weather and the quality of human life on Earth, free of any ideology, read the wonderful book by Reichholf. It explains how the weather between the continents is connected and describes how and why the weather changed in the last one thousand years.

Ref. 299

\* \*

Does self-organization or biological evolution contradict the second principle of thermodynamics? Of course not. Self-organization can even be shown to follow from the second principle, as any textbook on the topic will explain. Also for evolution there is no contradiction, as the Earth is not a closed thermodynamic system. Statements of the opposite are only made by crooks.

Ref. 300

\* \*



**FIGURE 225** A typical swarm of starlings that visitors in Rome can observe every fall (© Andrea Cavagna/Physics Today).

Ref. 301

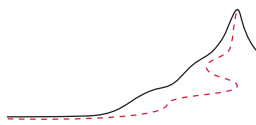
Are systems that show self-organization the most complex ones that can be studied with evolution equations? No. The most complex systems are those that consist of many interacting self-organizing systems. The obvious example are *swarms*. Swarms of birds, as shown in [Figure 225](#), of fish, of insects and of people – for example in a stadium or in cars on a highway – have been studied extensively and are still a subject of research. Their beauty is fascinating.

The other example of many interconnected self-organized systems is the brain; the exploration of how the interconnected neurons work will occupy researchers for many years. We will explore some aspects in the next volumes.

#### SUMMARY ON SELF-ORGANIZATION AND CHAOS

Appearance of order, in form of patterns, shapes and cycles, is not due to a decrease in entropy, but to a competition between driving causes and diffusive effects in open systems. Such appearance of order is predictable with (quite) simple equations. Chaos, the sensitivity to initial conditions, is common in strongly driven open systems, is at the basis of everyday chance, and often is described by simple equations. In nature, complexity is usually apparent: motion is simple.





# FROM THE LIMITATIONS OF PHYSICS TO THE LIMITS OF MOTION

“ I only know that I know nothing.  
Socrates, as cited by Plato ”

Up to this point, we have explored the everyday concept of motion. This exploration is called *Galilean physics*. The main result of this exploration of moving objects, fluids and heat is that in all these cases, motion is *predictable*: nature shows no surprises and no miracles. We have found six important aspects of this predictability:

1. Everyday motion is *continuous*. Motion allows us to define space and time.
2. Everyday motion *conserves* mass, momentum, energy and angular momentum. Nothing appears out of nothing.
3. Everyday motion is *relative*: motion depends on the observer.
4. Everyday motion is *reversible*: everyday motion can occur backwards.
5. Everyday motion is *mirror-invariant*: everyday motion can occur in a mirror-reversed way.
6. Everyday motion is *lazy*: motion happens in a way that minimizes change, i.e., physical action.

This Galilean description of nature made engineering possible: textile machines, steam engines, combustion motors, kitchen appliances, many children toys, fitness machines and all the progress in the quality of life that came with these devices are due to the results of Galilean physics. But despite these successes, Socrates' saying, cited above, still applies to Galilean physics. Let us see why.

## RESEARCH TOPICS IN CLASSICAL DYNAMICS

Ref. 302

Even though mechanics and thermodynamics are now several hundred years old, research into its details is still ongoing. For example, we have already mentioned above that it is unclear whether the solar system is stable. The long-term future of the planets is unknown! In general, the behaviour of few-body systems interacting through gravitation is still a research topic of mathematical physics. Answering the simple question of how long a given set of bodies gravitating around each other will stay together is a formidable challenge. The history of this so-called *many-body problem* is long and involved. Interesting progress has been achieved, but the final answer still eludes us.

Many challenges remain in the fields of self-organization, of nonlinear evolution equations, and of chaotic motion. In these fields, *turbulence* is the most famous example: a pre-

**TABLE 48** Examples of errors in state-of-the-art measurements (numbers in brackets give one standard deviation in the last digits), partly taken from [physics.nist.gov/constants](http://physics.nist.gov/constants).

OBSERVATION	MEASUREMENT	PRECISION / ACCURACY
Highest precision achieved: gyromagnetic ratio of the electron $\mu_e/\mu_B$	-1.001 159 652 181 11(74)	$7.4 \cdot 10^{-13}$
High precision: Rydberg constant	10 973 731.568 537(73) $\text{m}^{-1}$	$6.6 \cdot 10^{-12}$
High precision: astronomical unit	149 597 870.691(30) km	$2.0 \cdot 10^{-10}$
Industrial precision: part dimension tolerance in an automobile engine	1 $\mu\text{m}$ of 20 cm	$5 \cdot 10^{-6}$
Low precision: gravitational constant $G$	$6.674\,28(67) \cdot 10^{-11} \text{ Nm}^2/\text{kg}^2$	$1.0 \cdot 10^{-4}$
Everyday precision: human circadian clock governing sleep	15 to 75 h	2

cise description of turbulence has not yet been achieved. This and the other challenges motivate numerous researchers in mathematics, physics, chemistry, biology, medicine and the other natural sciences.

But apart from these research topics, classical physics leaves unanswered several basic questions.

#### WHAT IS CONTACT?

“Democritus declared that there is a unique sort of motion: that ensuing from collision.”  
Simplicius, *Commentary on the Physics of Aristotle*, 42, 10

Ref. 303

Page 88

Of the questions unanswered by classical physics, the details of *contact* and *collisions* are among the most pressing. Indeed, we defined mass in terms of velocity changes during collisions. But why do objects change their motion in such instances? Why are collisions between two balls made of chewing gum different from those between two stainless-steel balls? What happens during those moments of contact?

Contact is related to material properties, which in turn influence motion in a complex way. The complexity is such that the sciences of material properties developed independently from the rest of physics for a long time; for example, the techniques of metallurgy (often called the oldest science of all), of chemistry and of cooking were related to the properties of motion only in the twentieth century, after having been independently pursued for thousands of years. Since material properties determine the essence of contact, we *need* knowledge about matter and about materials to understand the notion of mass, and thus of motion. The parts of our mountain ascent that deal with quantum theory will reveal these connections.

#### PRECISION AND ACCURACY

Ref. 338  
Challenge 627 e

Precision has its own fascination. How many digits of  $\pi$ , the ratio between circumference and diameter of a circle, do you know by heart? What is the largest number of digits of

$\pi$  you have calculated yourself? These are questions about precision.

When we started climbing Motion Mountain, we explained that gaining height means increasing the *precision* of our description of nature. To make even this statement itself more precise, we distinguish between two terms: *precision* is the degree of reproducibility; *accuracy* is the degree of correspondence to the actual situation. Both concepts apply to measurements,\* to statements and to physical concepts.

Challenge 628 s Statements with false accuracy and false precision abound. What should we think of a car company – Ford – who claim that the drag coefficient  $c_w$  of a certain model is 0.375? Or of the official claim that the world record in fuel consumption for cars is 2315.473 km/l? Or of the statement that 70.3 % of all citizens share a certain opinion? One lesson we learn from investigations into measurement errors is that we should never provide more digits for a result than we can put our hand into fire for.

Challenge 629 s Is it possible to draw or cut a rectangle for which the ratio of lengths is a real number, e.g. of the form 0.131520091514001315211420010914..., whose digits encode a book? (A simple method would code a space as 00, the letter 'a' as 01, 'b' as 02, 'c' as 03, etc. Even more interestingly, could the number be printed inside its own book?)

Appendix B In short, precision and accuracy are *limited*. At present, the record number of reliable digits ever measured for a physical quantity is 13. Why so few? Classical physics doesn't provide an answer at all. What is the maximum number of digits we can expect in measurements; what determines it; and how can we achieve it? These questions are still open at this point in our ascent; they will be covered in the parts on quantum theory.

In our walk we aim for highest possible precision and accuracy, while avoiding false accuracy. Therefore, concepts have mainly to be *precise*, and descriptions have to be *accurate*. Any inaccuracy is a proof of lack of understanding. To put it bluntly, in our adventure, 'inaccurate' means *wrong*. Increasing the accuracy and precision of our description of nature implies leaving behind us all the mistakes we have made so far. This quest raises several issues.

### CAN ALL OF NATURE BE DESCRIBED IN A BOOK?

Could the perfect physics publication, one that describes all of nature, exist? If it does, it must also describe itself, its own production – including its readers and its author – and most important of all, its own contents. Is such a book possible? Using the concept of information, we can state that such a book should contain all information contained in the universe. Is this possible? Let us check the options.

If nature requires an *infinitely* long book to be fully described, such a publication obviously cannot exist. In this case, only approximate descriptions of nature are possible and a perfect physics book is impossible.

If nature requires a *finite* amount of information for its description, there are two options. One is that the information of the universe is so large that it cannot be summarized in a book; then a perfect physics book is again impossible. The other option is that the universe does contain a finite amount of information and that it can be summarized in a few short statements. This would imply that the rest of the universe would not add to the information already contained in the perfect physics book. But in this case, it seems

\* For measurements, both precision and accuracy are best described by their *standard deviation*, as explained on [page 352](#).

that the entropy of the book and the entropy of the universe must be similar. This is also impossible, or at least unlikely.

We note that the answer to this puzzle also implies the answer to another puzzle: whether a brain can contain a full description of nature. In other words, the real question is: can we understand nature? Is our hike to the top of motion mountain possible? We usually believe this.

But the arguments just given imply that we believe something which seems unlikely: we believe that the universe does not contain more information than what our brain could contain or even contains already. Do we have an error in our arguments? Yes, we do. The terms ‘universe’ and ‘information’ are not used correctly in the above reasoning, as you might want to verify. We will solve this puzzle later in our adventure. Until then, do make up your own mind.

Vol. III, page 100  
Challenge 630 e

### SOMETHING IS WRONG ABOUT OUR DESCRIPTION OF MOTION

“Darum kann es in der Logik auch *nie*  
Überraschungen geben.\*”  
Ludwig Wittgenstein, *Tractatus*, 6.1251

We described nature in a rather simple way. *Objects* are permanent and massive entities localized in space-time. *States* are changing properties of objects, described by position in space and instant in time, by energy and momentum, and by their rotational equivalents. *Time* is the relation between events measured by a clock. *Clocks* are devices in undisturbed motion whose position can be observed. *Space* and position is the relation between objects measured by a metre stick. *Metre sticks* are devices whose shape is subdivided by some marks, fixed in an invariant and observable manner. *Motion* is change of position with time (times mass); it is determined, does not show surprises, is conserved (even in death), and is due to gravitation and other interactions.

Challenge 631 s

Challenge 632 s

Even though this description works rather well in practice, it contains a circular definition. Can you spot it? Each of the two central concepts of motion is defined with the help of the other. Physicists worked for about 200 years on classical mechanics without noticing or wanting to notice the situation. Even thinkers with an interest in discrediting science did not point it out. Can an exact science be based on a circular definition? Obviously yes, and physics has done quite well so far. Is the situation unavoidable in principle? Undoing this logical loop is one of the aims of the rest of our walk. We will achieve the solution in the last leg of our adventure. To achieve the solution, we need to increase substantially the level of precision in our description of motion.

Whenever precision is increased, imagination is restricted. We will discover that many types of motion that seem possible are not. Motion is limited. Nature limits speed, size, acceleration, mass, force, power and many other quantities. Continue reading the other parts of this adventure only if you are prepared to exchange fantasy for precision. It will be no loss, because exploring the precise working of nature will turn out to be more fascinating than any fantasy.

\* ‘Hence there can *never* be surprises in logic.’



### WHY IS MEASUREMENT POSSIBLE?

In the description of gravity given so far, the one that everybody learns – or should learn – at school, acceleration is connected to mass and distance via  $a = GM/r^2$ . That's all. But this simplicity is deceiving. In order to check whether this description is correct, we have to measure lengths and times. However, it is *impossible* to measure lengths and time intervals with any clock or any ruler based on the gravitational interaction alone! Try to conceive such an apparatus and you will be inevitably be disappointed. You always need a non-gravitational method to start and stop the stopwatch. Similarly, when you measure length, e.g. of a table, you have to hold a ruler or some other device near it. The interaction necessary to line up the ruler and the table cannot be gravitational.

Challenge 633 s

A similar limitation applies even to mass measurements. Try to measure mass using gravitation alone. Any scale or balance needs other – usually mechanical, electromagnetic or optical – interactions to achieve its function. Can you confirm that the same applies to speed and to angle measurements? In summary, whatever method we use, *in order to measure velocity, length, time, and mass, interactions other than gravity are needed*. Our ability to measure shows that gravity is not all there is.

Challenge 634 s

Challenge 635 s

In short, Galilean physics does not explain our ability to measure. In fact, it does not even explain the existence of measurement standards. Why do objects have fixed lengths? Why do clocks work with regularity? Galilean physics cannot explain these observations; we will need relativity and quantum physics to find out.

### IS MOTION UNLIMITED?

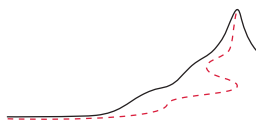
Galilean physics suggests that motion could go on forever. In fact, Galilean physics makes no clear statements on the universe as a whole. It tacitly suggests that it is infinite. Indeed, finitude does not fit with the Galilean description of motion. On the other hand, we know that the universe is *not* infinite: if it were infinite, the night would not be dark. Galilean physics is thus limited in its explanations because it disregards this and other limits to motion.

Challenge 636 e

In particular, Galilean physics suggests that speeds can have any value. But the existence of infinite speeds in nature would not allow us to define time sequences. Clocks would be impossible. In other words, a description of nature that allows unlimited speeds is not precise. Precision requires limits. To achieve the highest possible precision, we need to discover all limits to motion. So far, we have discovered only one: there is a smallest entropy. We now turn to another, more striking one: the limit for speed of energy, objects and signals. To understand this limit, in the next volume we will explore the most rapid motion of energy, objects and signals that we know: the motion of light.







## NOTATION AND CONVENTIONS

Vol. V, page 260

Ref. 304

**N**EWLY introduced and defined concepts in this text are indicated by *italic typeface*. New definitions are also referred to in the index by italic page numbers. We naturally use SI units throughout the text; these are defined in [Appendix B](#). Experimental results are cited with limited precision, usually only two digits, as this is almost always sufficient for our purposes. High-precision reference values can be found in [Appendix B](#). Additional precision values on composite physical systems are given in volume V.

In relativity we use the time convention, where the metric has the signature  $(+ - - -)$ . This is used in about 70 % of the literature worldwide. We use indices  $i, j, k$  for 3-vectors and indices  $a, b, c$ , etc. for 4-vectors. The conventions specific to general relativity are explained as they arise in the text.

## THE LATIN ALPHABET

Ref. 305

“What is written without effort is in general read without pleasure.”  
Samuel Johnson

Books are collections of symbols. *Writing* was probably invented between 3400 and 3300 BCE by the Sumerians in Mesopotamia (though other possibilities are also discussed). It then took over a thousand years before people started using symbols to represent sounds instead of concepts: this is the way in which the first alphabet was created. This happened between 2000 and 1600 BCE (possibly in Egypt) and led to the Semitic alphabet. The use of an alphabet had so many advantages that it was quickly adopted in all neighbouring cultures, though in different forms. As a result, the Semitic alphabet is the forefather of all alphabets used in the world.

This text is written using the Latin alphabet. At first sight, this seems to imply that its pronunciation *cannot* be explained in print, in contrast to the pronunciation of other alphabets or of the International Phonetic Alphabet (IPA). (They can be explained using the alphabet of the main text.) However, it is in principle possible to write a text that describes exactly how to move lips, mouth and tongue for each letter, using physical concepts where necessary. The descriptions of pronunciations found in dictionaries make indirect use of this method: they refer to the memory of pronounced words or sounds found in nature.

Historically, the Latin alphabet was derived from the Etruscan, which itself was a derivation of the Greek alphabet. There are two main forms.

The *ancient* Latin alphabet,  
used from the sixth century BCE onwards:

A B C D E F Z H I K L M N O P Q R S T V X

The *classical* Latin alphabet,  
used from the second century BCE until the eleventh century:

A B C D E F G H I K L M N O P Q R S T V X Y Z

The letter G was added in the third century BCE by the first Roman to run a fee-paying school, Spurius Carvilius Ruga. He added a horizontal bar to the letter C and substituted the letter Z, which was not used in Latin any more, for this new letter. In the second century BCE, after the conquest of Greece, the Romans included the letters Y and Z from the Greek alphabet at the end of their own (therefore effectively reintroducing the Z) in order to be able to write Greek words. This classical Latin alphabet was stable for the next thousand years.\*

The classical Latin alphabet was spread around Europe, Africa and Asia by the Romans during their conquests; due to its simplicity it began to be used for writing in numerous other languages. Most modern 'Latin' alphabets include a few other letters. The letter W was introduced in the eleventh century in French and was then adopted in most European languages.\*\* The letter U was introduced in the mid fifteenth century in Italy, the letter J at the end of that century in Spain, to distinguish certain sounds which had previously been represented by V and I. The distinction proved a success and was already common in most European languages in the sixteenth century. The contractions æ and œ date from the Middle Ages. The German alphabet includes the *sharp s*, written ß, a contraction of 'ss' or 'sz', and the Nordic alphabets added *thorn*, written Þ or þ, and *eth*, written Ð or ð, both taken from the futhorc,\*\*\* and other signs.

Lower-case letters were not used in classical Latin; they date only from the Middle Ages, from the time of Charlemagne. Like most accents, such as ê, ç or ä, which were also first used in the Middle Ages, lower-case letters were introduced to save the then expensive paper surface by shortening written words.

“ Outside a dog, a book is a man's best friend.  
Inside a dog, it's too dark to read. ”  
Groucho Marx

\* To meet Latin speakers and writers, go to [www.alcuinus.net](http://www.alcuinus.net).

\*\* In Turkey, still in 2008, you can be convoked in front of a judge if you use the letters w, q or x in an official letter; these letters only exist in the Kurdish language, not in Turkish. Using them is 'unturkish' behaviour and punishable by law. It is not generally known how physics teachers cope with this situation.

\*\*\* The Runic script, also called *Futhark* or *Futhorc*, a type of alphabet used in the Middle Ages in Germanic, Anglo-Saxon and Nordic countries, probably also derives from the Etruscan alphabet. The name derives from the first six letters: f, u, th, a (or o), r, k (or c). The third letter is the letter thorn mentioned above; it is often written 'Y' in Old English, as in 'Ye Olde Shoppe.' From the runic alphabet Old English also took the letter *wyn* to represent the 'w' sound, and the already mentioned *eth*. (The other letters used in Old English – not from futhorc – were the *yogh*, an ancient variant of g, and the ligatures æ or Æ, called *ash*, and œ or Œ, called *ethel*.)

**TABLE 49** The ancient and classical Greek alphabets, and the correspondence with Latin and Indian digits.

ANC.	CLASS.	NAME	CORRESP.	ANC.	CLASS.	NAME	CORRESP.
A	A	α	alpha	a	1	N	N ν nu n 50
B	B	β	beta	b	2	Ξ	Ξ ξ xi x 60
Γ	Γ	γ	gamma	g, n <sup>1</sup>	3	O	O ο omicron o 70
Δ	Δ	δ	delta	d	4	Π	Π π pi p 80
E	E	ε	epsilon	e	5	Ϟ ϙ, Ϛ	Ϟ ϙ Ϛ qoppa <sup>3</sup> q 90
F	F, Ϛ		digamma, stigma <sup>2</sup>	w	6	P	P ρ rho r, rh 100
Z	Z	ζ	zeta	z	7	Σ	Σ σ, Ϙ sigma <sup>4</sup> s 200
H	H	η	eta	e	8	T	T τ tau t 300
Θ	Θ	θ	theta	th	9	Υ	Υ υ upsilon y, u <sup>5</sup> 400
I	I	ι	iota	i, j	10	Φ	Φ φ phi ph, f 500
K	K	κ	kappa	k	20	X	X χ chi ch 600
Λ	Λ	λ	lambda	l	30	Ψ	Ψ ψ psi ps 700
M	M	μ	mu	m	40	Ω	Ω ω omega o 800
						Ϻ	Ϻ ϻ sampi <sup>6</sup> s 900

The regional archaic letters yot, sha and san are not included in the table. The letter san was the ancestor of sampi.

1. Only if before velars, i.e., before kappa, gamma, xi and chi.
2. 'Digamma' is the name used for the F-shaped form. It was mainly used as a letter (but also sometimes, in its lower-case form, as a number), whereas the shape and name 'stigma' is used only for the number. Both names were derived from the respective shapes; in fact, the stigma is a medieval, uncial version of the digamma. The name 'stigma' is derived from the fact that the letter looks like a sigma with a tau attached under it – though unfortunately not in all modern fonts. The original letter name, also giving its pronunciation, was 'waw'.
3. The version of qoppa that looks like a reversed and rotated z is still in occasional use in modern Greek. Unicode calls this version 'koppa'.
4. The second variant of sigma is used only at the end of words.
5. Upsilon corresponds to 'u' only as the second letter in diphthongs.
6. In older times, the letter sampi was positioned between pi and qoppa.

### THE GREEK ALPHABET

Ref. 309 The Latin alphabet was derived from the Etruscan; the Etruscan from the Greek. The Greek alphabet was itself derived from the Phoenician or a similar northern Semitic alphabet in the tenth century BCE. The Greek alphabet, for the first time, included letters also for vowels, which the Semitic alphabets lacked (and often still lack). In the Phoenician alphabet and in many of its derivatives, such as the Greek alphabet, each letter has a proper name. This is in contrast to the Etruscan and Latin alphabets. The first two Greek letter names are, of course, the origin of the term *alphabet* itself.

In the tenth century BCE, the Ionian or *ancient* (eastern) Greek alphabet consisted of the upper-case letters only. In the sixth century BCE several letters were dropped, while a few new ones and the lower-case versions were added, giving the *classical* Greek alphabet.

Still later, accents, subscripts and breathings were introduced. Table 49 also gives the values signified by the letters took when they were used as numbers. For this special use, the obsolete ancient letters were kept during the classical period; thus they also acquired lower-case forms.

The Latin correspondence in the table is the standard classical one, used for writing Greek words. The question of the correct *pronunciation* of Greek has been hotly debated in specialist circles; the traditional *Erasmian* pronunciation does not correspond either to the results of linguistic research, or to modern Greek. In classical Greek, the sound that sheep make was  $\beta\eta$ – $\beta\eta$ . (Erasmian pronunciation wrongly insists on a narrow  $\eta$ ; modern Greek pronunciation is different for  $\beta$ , which is now pronounced ‘v’, and for  $\eta$ , which is now pronounced as ‘i:’ – a long ‘i.’) Obviously, the pronunciation of Greek varied from region to region and over time. For Attic Greek, the main dialect spoken in the classical period, the question is now settled. Linguistic research has shown that chi, phi and theta were less aspirated than usually pronounced in English and sounded more like the initial sounds of ‘cat’, ‘perfect’ and ‘tin’; moreover, the zeta seems to have been pronounced more like ‘zd’ as in ‘buzzed’. As for the vowels, contrary to tradition, epsilon is closed and short whereas eta is open and long; omicron is closed and short whereas omega is wide and long, and upsilon is really a ‘u’ sound as in ‘boot’, not like a French ‘u’ or German ‘ü.’

The Greek vowels can have rough or smooth *breathings*, *subscripts*, and acute, grave, circumflex or diaeresis *accents*. Breathings – used also on  $\rho$  – determine whether the letter is aspirated. Accents, which were interpreted as stresses in the Erasmian pronunciation, actually represented pitches. Classical Greek could have up to three of these added signs per letter; modern Greek never has more than one.

Another descendant of the Greek alphabet\* is the *Cyrillic alphabet*, which is used with slight variations, in many Slavic languages, such as Russian and Bulgarian. However, there is no standard transcription from Cyrillic to Latin, so that often the same Russian name is spelled differently in different countries or even in the same country on different occasions.

TABLE 50 The beginning of the Hebrew abjad.

LETTER	NAME	CORRESPONDENCE	
א	aleph	a	1
ב	beth	b	2
ג	gimel	g	3
ד	daleth	d	4
etc.			

\* The Greek alphabet is also the origin of the *Gothic alphabet*, which was defined in the fourth century by Wulfila for the Gothic language, using also a few signs from the Latin and futhorc scripts.

The Gothic alphabet is not to be confused with the so-called *Gothic letters*, a style of the *Latin* alphabet used all over Europe from the eleventh century onwards. In Latin countries, Gothic letters were replaced in the sixteenth century by the *Antiqua*, the ancestor of the type in which this text is set. In other countries, Gothic letters remained in use for much longer. They were used in type and handwriting in Germany until 1941, when the National Socialist government suddenly abolished them, in order to comply with popular demand. They remain in sporadic use across Europe. In many physics and mathematics books, Gothic letters are used to denote vector quantities.

### THE HEBREW ALPHABET AND OTHER SCRIPTS

Ref. 310  
Vol. III, page 198

The Phoenician alphabet is also the origin of the Hebrew consonant alphabet or *abjad*. Its first letters are given in Table 50. Only the letter aleph is commonly used in mathematics, though others have been proposed.

Around one hundred writing systems are in use throughout the world. Experts classify them into five groups. *Phonemic alphabets*, such as Latin or Greek, have a sign for each consonant and vowel. *Abjads* or consonant alphabets, such as Hebrew or Arabic, have a sign for each consonant (sometimes including some vowels, such as aleph), and do not write (most) vowels; most abjads are written from right to left. *Abugidas*, also called syllabic alphabets or alphasyllabaries, such as Balinese, Burmese, Devanagari, Tagalog, Thai, Tibetan or Lao, write consonants and vowels; each consonant has an inherent vowel which can be changed into the others by diacritics. *Syllabaries*, such as Hiragana or Ethiopic, have a sign for each syllable of the language. Finally, complex scripts, such as Chinese, Mayan or the Egyptian hieroglyphs, use signs which have both sound and meaning. Writing systems can have text flowing from right to left, from bottom to top, and can count book pages in the opposite sense to this book.

Ref. 311

Even though there are about 7000 languages on Earth, there are only about one hundred writing systems used today. About fifty other writing systems have fallen out of use. \* For physical and mathematical formulae, though, the sign system used in this text, based on Latin and Greek letters, written from left to right and from top to bottom, is a standard the world over. It is used independently of the writing system of the text containing it.

### NUMBERS AND THE INDIAN DIGITS

Ref. 312

Both the digits and the method used in this text to write numbers originated in India. They were brought to the Mediterranean by Arabic mathematicians in the Middle Ages. The number system used in this text is thus much younger than the alphabet.\*\* The Indian numbers were made popular in Europe by Leonardo of Pisa, called Fibonacci,\*\*\* in his book *Liber Abaci* or 'Book of Calculation', which he published in 1202. That book revolutionized mathematics. Anybody with paper and a pen (the pencil had not yet been invented) was now able to calculate and write down numbers as large as reason allowed, or even larger, and to perform calculations with them. Fibonacci's book started:

Novem figure indorum he sunt 9 8 7 6 5 4 3 2 1. Cum his itaque novem figuris, et cum hoc signo 0, quod arabice zephirum appellatur, scribitur quilibet numerus, ut inferius demonstratur.\*\*\*\*

\* A well-designed website on the topic is [www.omniglot.com](http://www.omniglot.com). The main present and past writing systems are encoded in the Unicode standard, which at present contains 52 writing systems. See [www.unicode.org](http://www.unicode.org).

\*\* It is not correct to call the digits 0 to 9 *Arabic*. Both the digits used in Arabic texts and the digits used in Latin texts such as this one derive from the Indian digits. Only the digits 0, 2, 3 and 7 resemble those used in Arabic writing, and then only if they are turned clockwise by 90°.

\*\*\* Leonardo di Pisa, called Fibonacci (b. c. 1175 Pisa, d. 1250 Pisa), Italian mathematician, and the most important mathematician of his time.

\*\*\*\* 'The nine figures of the Indians are: 9 8 7 6 5 4 3 2 1. With these nine figures, and with this sign 0 which in Arabic is called zephirum, any number can be written, as will be demonstrated below.'

The Indian method of writing numbers, the *Indian number system*, introduced two innovations: a large one, the *positional system*, and a small one, the digit zero. The positional system, as described by Fibonacci, was so much more efficient that it completely replaced the previous *Roman number system*, which writes 1996 as IVMM or MCMIVC or MCMXCVI, as well as the *Greek number system*, in which the Greek letters were used for numbers in the way shown in Table 49, thus writing 1996 as ,αϑος'. Compared to these systems, the Indian numbers are a much better technology.

The Indian number system proved so practical that calculations done on paper completely eliminated the need for the *abacus*, which therefore fell into disuse. The abacus is still in use only in those countries which do not use a positional system to write numbers.

The Indian number system also eliminated the need for systems to represent numbers with fingers. Such ancient systems, which could show numbers up to 10 000 and more, have left only one trace: the term 'digit' itself, which derives from the Latin word for finger.

The power of the positional number system is often forgotten. But only a positional number system allows mental calculations and makes calculating prodigies possible.\*

#### THE SYMBOLS USED IN THE TEXT

“To avoide the tedious repetition of these wordes: is equalle to: I will sette as I doe often in woorke use, a paire of paraleles, or Gemowe lines of one lengthe, thus: = , bicause noe .2. thynges, can be moare equalle.”

Robert Recorde\*\*

Besides text and numbers, physics books contain other symbols. Most symbols have been developed over hundreds of years, so that only the clearest and simplest are now in use. In this mountain ascent, the symbols used as abbreviations for *physical* quantities are all taken from the Latin or Greek alphabets and are always defined in the context where they are used. The symbols designating units, constants and particles are defined in Appendix B and Appendix B. There is an international standard for them (ISO 80000, formerly ISO 31), but it is shamefully expensive and thus virtually inaccessible; the symbols used in this text are those in common use.

Ref. 310

The *mathematical* symbols used in this text, in particular those for operations and relations, are given in the following list, together with their origins. The details of their history have been extensively studied in the literature.

Ref. 314

\* Currently, the shortest time for finding the thirteenth (integer) root of a hundred-digit (integer) number, a result with 8 digits, is 11.8 seconds. For more about the stories and the methods of calculating prodigies, see the bibliography.

Ref. 313

\*\* Robert Recorde (c. 1510–1558), English mathematician and physician; he died in prison because of debts. The quotation is from his *The Whetstone of Witte*, 1557. An image showing the quote can be found at [en.wikipedia.org/wiki/Equals\\_sign](http://en.wikipedia.org/wiki/Equals_sign). It is usually suggested that the quote is the first introduction of the equal sign; claims that Italian mathematicians used the equal sign before Recorde are not backed up by convincing examples.

Ref. 314

SYMBOL	MEANING	ORIGIN
+, −	plus, minus	J. Regiomontanus 1456; the plus sign is derived from Latin 'et'
$\sqrt{\quad}$	read as 'square root'	used by C. Rudolff in 1525; the sign stems from a deformation of the letter 'r', initial of the Latin <i>radix</i>
=	equal to	R. Recorde 1557
{ }, [ ], ( )	grouping symbols	use starts in the sixteenth century
>, <	larger than, smaller than	T. Harriot 1631
×	multiplied with, times	W. Oughtred 1631
:	divided by	G. Leibniz 1684
·	multiplied with, times	G. Leibniz 1698
$a^n$	power	R. Descartes 1637
$x, y, z$	coordinates, unknowns	R. Descartes 1637
$ax+by+c=0$	constants and equations for unknowns	R. Descartes 1637
$d/dx, \quad dx, \int y \, dx$	derivative, differential, integral	G. Leibniz 1675
$\varphi x$	function of $x$	J. Bernoulli 1718
$f x, f(x)$	function of $x$	L. Euler 1734
$\Delta x, \Sigma$	difference, sum	L. Euler 1755
$\neq$	is different from	L. Euler eighteenth century
$\partial/\partial x$	partial derivative, read like 'd/dx'	it was derived from a cursive form of 'd' or of the letter 'dey' of the Cyrillic alphabet by A. Legendre in 1786
$\Delta$	Laplace operator	R. Murphy 1833
$ x $	absolute value	K. Weierstrass 1841
$\nabla$	read as 'nabla' (or 'del')	introduced by William Hamilton in 1853 and P.G. Tait in 1867, named after the shape of an old Egyptian musical instrument
$[x]$	the measurement unit of a quantity $x$	twentieth century
$\infty$	infinity	J. Wallis 1655
$\pi$	$4 \arctan 1$	H. Jones 1706
$e$	$\sum_{n=0}^{\infty} \frac{1}{n!} = \lim_{n \rightarrow \infty} (1 + 1/n)^n$	L. Euler 1736
$i$	$+\sqrt{-1}$	L. Euler 1777
$\cup, \cap$	set union and intersection	G. Peano 1888
$\in$	element of	G. Peano 1888
$\emptyset$	empty set	André Weil as member of the N. Bourbaki group in the early twentieth century
$\langle \psi  ,   \psi \rangle$	bra and ket state vectors	Paul Dirac 1930
$\otimes$	dyadic product or tensor product or outer product	unknown



Other signs used here have more complicated origins. The & sign is a contraction of Latin *et* meaning ‘and’, as is often more clearly visible in its variations, such as & , the common italic form.

Each of the punctuation signs used in sentences with modern Latin alphabets, such as , . ; : ! ? ‘ ’ » « – ( ) ... has its own history. Many are from ancient Greece, but the question mark is from the court of Charlemagne, and exclamation marks appear first in the sixteenth century.\* The @ or *at-sign* probably stems from a medieval abbreviation of Latin *ad*, meaning ‘at’, similarly to how the & sign evolved from Latin *et*. In recent years, the *smiley* :-) and its variations have become popular. The smiley is in fact a new version of the ‘point of irony’ which had been formerly proposed, without success, by A. de Brahm (1868–1942).

The section sign § dates from the thirteenth century in northern Italy, as was shown by the German palaeographer Paul Lehmann. It was derived from ornamental versions of the capital letter C for *capitulum*, i.e., ‘little head’ or ‘chapter.’ The sign appeared first in legal texts, where it is still used today, and then spread into other domains.

The paragraph sign ¶ was derived from a simpler ancient form looking like the Greek letter Γ, a sign which was used in manuscripts from ancient Greece until well into the Middle Ages to mark the start of a new text paragraph. In the Middle Ages it took the modern form, probably because a letter c for *caput* was added in front of it.

One of the most important signs of all, the *white space* separating words, was due to Celtic and Germanic influences when these people started using the Latin alphabet. It became commonplace between the ninth and the thirteenth century, depending on the language in question.

## CALENDARS

The many ways to keep track of time differ greatly from civilization to civilization. The most common calendar, and the one used in this text, is also one of the most absurd, as it is a compromise between various political forces who tried to shape it.

In ancient times, independent localized entities, such as tribes or cities, preferred *lunar* calendars, because lunar timekeeping is easily organized locally. This led to the use of the month as a calendar unit. Centralized states imposed *solar* calendars, based on the year. Solar calendars require astronomers, and thus a central authority to finance them. For various reasons, farmers, politicians, tax collectors, astronomers, and some, but not all, religious groups wanted the calendar to follow the solar year as precisely as possible. The compromises necessary between days and years are the origin of leap days. The compromises necessary between months and year led to the varying lengths are different in different calendars. The most commonly used year–month structure was organized over 2000 years ago by Gaius Julius Caesar, and is thus called the *Julian calendar*.

The system was destroyed only a few years later: August was lengthened to 31 days when it was named after Augustus. Originally, the month was only 30 days long; but in order to show that Augustus was as important as Caesar, after whom July is named, all month lengths in the second half of the year were changed, and February was shortened by an additional day.

---

\* On the parenthesis see the beautiful book by J. LENNARD, *But I Digress*, Oxford University Press, 1991.

Ref. 320 The *week* is an invention of Babylonia. One day in the Babylonian week was ‘evil’ or ‘unlucky’, so it was better to do nothing on that day. The modern week cycle with its resting day descends from that superstition. (The way astrological superstition and astronomy cooperated to determine the order of the weekdays is explained in the section on gravitation.) Although about three thousand years old, the week was fully included into the Julian calendar only around the year 300, towards the end of the Western Roman Empire. The final change in the Julian calendar took place between 1582 and 1917 (depending on the country), when more precise measurements of the solar year were used to set a new method to determine leap days, a method still in use today. Together with a reset of the date and the fixation of the week rhythm, this standard is called the *Gregorian calendar* or simply the *modern calendar*. It is used by a majority of the world’s population.

Page 178

Despite its complexity, the modern calendar does allow you to determine the day of the week of a given date in your head. Just execute the following six steps:

1. take the last two digits of the year, and divide by 4, discarding any fraction;
2. add the last two digits of the year;
3. subtract 1 for January or February of a leap year;
4. add 6 for 2000s or 1600s, 4 for 1700s or 2100s,  
2 for 1800s and 2200s, and 0 for 1900s or 1500s;
5. add the day of the month;
6. add the month key value, namely 144 025 036 146 for JFM AMJ JAS OND.

The remainder after division by 7 gives the day of the week, with the correspondence 1-2-3-4-5-6-0 meaning Sunday-Monday-Tuesday-Wednesday-Thursday-Friday-Saturday.\*

When to start counting the years is a matter of choice. The oldest method not attached to political power structures was that used in ancient Greece, when years were counted from the first Olympic games. People used to say, for example, that they were born in the first year of the twenty-third Olympiad. Later, political powers always imposed the counting of years from some important event onwards.\*\* Maybe reintroducing the Olympic

\* Remembering the intermediate result for the current year can simplify things even more, especially since the dates 4.4, 6.6, 8.8, 10.10, 12.12, 9.5, 5.9, 7.11, 11.7 and the last day of February all fall on the same day of the week, namely on the year’s intermediate result plus 4.

\*\* The present counting of years was defined in the Middle Ages by setting the date for the foundation of Rome to the year 753 BCE, or 753 *before the Common Era*, and then counting backwards, so that the BCE years behave almost like negative numbers. However, the year 1 follows directly after the year 1 BCE: there was no year 0.

- Some other standards set by the Roman Empire explain several abbreviations used in the text:
- *c.* is a Latin abbreviation for *circa* and means ‘roughly’;
  - *i.e.* is a Latin abbreviation for *id est* and means ‘that is’;
  - *e.g.* is a Latin abbreviation for *exempli gratia* and means ‘for the sake of example’;
  - *ibid.* is a Latin abbreviation for *ibidem* and means ‘at that same place’;
  - *inf.* is a Latin abbreviation for *infra* and means ‘(see) below’;
  - *op. cit.* is a Latin abbreviation for *opus citatum* and means ‘the cited work’;
  - *et al.* is a Latin abbreviation for *et alii* and means ‘and others’.

By the way, *idem* means ‘the same’ and *passim* means ‘here and there’ or ‘throughout’. Many terms used in physics, like frequency, acceleration, velocity, mass, force, momentum, inertia, gravitation and temperature, are derived from Latin. In fact, it is arguable that the language of science has been Latin for over two thousand years. In Roman times it was Latin vocabulary with Latin grammar, in modern times it switched to Latin vocabulary with French grammar, then for a short time to Latin vocabulary with German grammar,

counting is worth considering?

### PEOPLE NAMES

In the Far East, such as *Corea*, *Japan* or *China*, family names are put in front of the given name. For example, the first Japanese winner of the Nobel Prize in Physics was Yukawa Hideki. In *India*, often, but not always, there is no family name; in those cases, the father's first name is used. In *Russia*, the family name is rarely used in conversation; instead, the first name of the father is. For example, Lev Landau was addressed as Lev Davidovich ('son of David'). In addition, Russian transliteration is not standardized; it varies from country to country and from tradition to tradition. For example, one finds the spellings Dostojewski, Dostoevskij, Dostoïevski and Dostoyevsky for the same person. In the *Netherlands*, the official given names are never used; every person has a semi-official first name by which he is called. For example, Gerard 't Hooft's official given name is Gerardus. In *Germany*, some family names have special pronounciations. For example, Voigt is pronounced 'Fohgt'. In *Italy*, during the Middle Age and the Renaissance, people were called by their first name only, such as Michelangelo or Galileo, or often by first name plus a personal surname that was not their family name, but was used like one, such as Niccolò Tartaglia or Leonardo Fibonacci. In *ancient Rome*, the name by which people are known is usually their surname. The family name was the middle name. For example, Cicero's family name was Tullius. The law introduced by Cicero was therefore known as 'lex Tullia'. In *ancient Greece*, there were no family names. People had only one name. In the English language, the Latin version of the Greek name is used, such as Democritus.

### ABBREVIATIONS AND EPONYMS OR CONCEPTS?

Sentences like the following are the scourge of modern physics:

The EPR paradox in the Bohm formulation can perhaps be resolved using the GRW approach, using the WKB approximation of the Schrödinger equation.

Using such vocabulary is the best way to make language unintelligible to outsiders. First of all, it uses abbreviations, which is a shame. On top of this, the sentence uses people's names to characterize concepts, i.e., it uses *eponyms*. Originally, eponyms were intended as tributes to outstanding achievements. Today, when formulating radical new laws or variables has become nearly impossible, the spread of eponyms intelligible to a steadily decreasing number of people simply reflects an increasingly ineffective drive to fame.

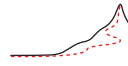
Eponyms are a proof of scientist's lack of imagination. We avoid them as much as possible in our walk and give *common* names to mathematical equations or entities wherever possible. People's names are then used as appositions to these names. For example, 'Newton's equation of motion' is never called 'Newton's equation'; 'Einstein's field equations' is used instead of 'Einstein's equations'; and 'Heisenberg's equation of motion' is used instead of 'Heisenberg's equation'.

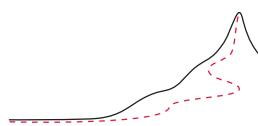
after which it changed to Latin vocabulary with British/American grammar.

Ref. 321 Many units of measurement also date from Roman times, as explained in the next appendix. Even the infatuation with Greek technical terms, as shown in coinages such as 'gyroscope', 'entropy' or 'proton', dates from Roman times.

However, some exceptions are inevitable: certain terms used in modern physics have no real alternatives. The Boltzmann constant, the Planck scale, the Compton wavelength, the Casimir effect, Lie groups and the Virasoro algebra are examples. In compensation, the text makes sure that you can look up the definitions of these concepts using the index.

Ref. 322 In addition, it tries to provide pleasurable reading.





## APPENDIX B

# UNITS, MEASUREMENTS AND CONSTANTS

**M**EASUREMENTS are comparisons with standards. Standards are based on a *unit*. Many different systems of units have been used throughout the world. Most standards confer power to the organization in charge of them. Such power can be misused; this is the case today, for example in the computer industry, and was so in the distant past. The solution is the same in both cases: organize an independent and global standard. For units, this happened in the eighteenth century: to avoid misuse by authoritarian institutions, to eliminate problems with differing, changing and irreproducible standards, and – this is not a joke – to simplify tax collection, a group of scientists, politicians and economists agreed on a set of units. It is called the *Système International d’Unités*, abbreviated *SI*, and is defined by an international treaty, the ‘Convention du Mètre’. The units are maintained by an international organization, the ‘Conférence Générale des Poids et Mesures’, and its daughter organizations, the ‘Commission Internationale des Poids et Mesures’ and the ‘Bureau International des Poids et Mesures’ (BIPM), which all originated in the times just before the French revolution.

Ref. 323

### SI UNITS

All SI units are built from seven *base units*, whose official definitions, translated from French into English, are given below, together with the dates of their formulation:

- ‘The *second* is the duration of 9 192 631 770 periods of the radiation corresponding to the transition between the two hyperfine levels of the ground state of the caesium 133 atom.’ (1967)\*
- ‘The *metre* is the length of the path travelled by light in vacuum during a time interval of  $1/299\,792\,458$  of a second.’ (1983)
- ‘The *kilogram* is the unit of mass; it is equal to the mass of the international prototype of the kilogram.’ (1901)\*
- ‘The *ampere* is that constant current which, if maintained in two straight parallel conductors of infinite length, of negligible circular cross-section, and placed 1 metre apart in vacuum, would produce between these conductors a force equal to  $2 \cdot 10^{-7}$  newton per metre of length.’ (1948)
- ‘The *kelvin*, unit of thermodynamic temperature, is the fraction  $1/273.16$  of the thermodynamic temperature of the triple point of water.’ (1967)\*
- ‘The *mole* is the amount of substance of a system which contains as many elementary entities as there are atoms in 0.012 kilogram of carbon 12.’ (1971)\*
- ‘The *candela* is the luminous intensity, in a given direction, of a source that emits

monochromatic radiation of frequency  $540 \cdot 10^{12}$  hertz and has a radiant intensity in that direction of  $(1/683)$  watt per steradian.’ (1979)\*

Note that both time and length units are defined as certain properties of a standard example of motion, namely light. In other words, also the Conférence Générale des Poids et Mesures makes the point that the observation of motion is a *prerequisite* for the definition and construction of time and space. *Motion is the fundament each observation and measurements.* By the way, the use of light in the definitions had been proposed already in 1827 by Jacques Babinet.\*

From these basic units, all other units are defined by multiplication and division. Thus, all SI units have the following properties:

- SI units form a system with *state-of-the-art precision*: all units are defined with a precision that is higher than the precision of commonly used measurements. Moreover, the precision of the definitions is regularly being improved. The present relative uncertainty of the definition of the second is around  $10^{-14}$ , for the metre about  $10^{-10}$ , for the kilogram about  $10^{-9}$ , for the ampere  $10^{-7}$ , for the mole less than  $10^{-6}$ , for the kelvin  $10^{-6}$  and for the candela  $10^{-3}$ .

- SI units form an *absolute* system: all units are defined in such a way that they can be reproduced in every suitably equipped laboratory, independently, and with high precision. This avoids as much as possible any misuse by the standard-setting organization. (The kilogram, still defined with the help of an artefact, is the last exception to this requirement; extensive research is under way to eliminate this artefact from the definition – an international race that will take a few more years. There are two approaches: counting particles, or fixing  $\hbar$ . The former can be achieved in crystals, the latter using any formula where  $\hbar$  appears, such as the formula for the de Broglie wavelength or that of the Josephson effect.)

- SI units form a *practical* system: the base units are quantities of everyday magnitude. Frequently used units have standard names and abbreviations. The complete list includes the seven base units, the supplementary units, the derived units and the admitted units.

The *supplementary* SI units are two: the unit for (plane) angle, defined as the ratio of arc length to radius, is the *radian* (rad). For solid angle, defined as the ratio of the subtended area to the square of the radius, the unit is the *steradian* (sr).

The *derived* units with special names, in their official English spelling, i.e., without capital letters and accents, are:

Page 88  
Ref. 324

\* The respective symbols are s, m, kg, A, K, mol and cd. The international prototype of the kilogram is a platinum–iridium cylinder kept at the BIPM in Sèvres, in France. For more details on the levels of the caesium atom, consult a book on atomic physics. The Celsius scale of temperature  $\theta$  is defined as:  $\theta/^{\circ}\text{C} = T/\text{K} - 273.15$ ; note the small difference with the number appearing in the definition of the kelvin. SI also states: ‘When the mole is used, the elementary entities must be specified and may be atoms, molecules, ions, electrons, other particles, or specified groups of such particles.’ In the definition of the mole, it is understood that the carbon 12 atoms are unbound, at rest and in their ground state. In the definition of the candela, the frequency of the light corresponds to 555.5 nm, i.e., green colour, around the wavelength to which the eye is most sensitive.

\* Jacques Babinet (1794–1874), French physicist who published important work in optics.

NAME	ABBREVIATION	NAME	ABBREVIATION
hertz	Hz = 1/s	newton	N = kg m/s <sup>2</sup>
pascal	Pa = N/m <sup>2</sup> = kg/m s <sup>2</sup>	joule	J = Nm = kg m <sup>2</sup> /s <sup>2</sup>
watt	W = kg m <sup>2</sup> /s <sup>3</sup>	coulomb	C = As
volt	V = kg m <sup>2</sup> /As <sup>3</sup>	farad	F = As/V = A <sup>2</sup> s <sup>4</sup> /kg m <sup>2</sup>
ohm	Ω = V/A = kg m <sup>2</sup> /A <sup>2</sup> s <sup>3</sup>	siemens	S = 1/Ω
weber	Wb = Vs = kg m <sup>2</sup> /As <sup>2</sup>	tesla	T = Wb/m <sup>2</sup> = kg/As <sup>2</sup> = kg/Cs
henry	H = Vs/A = kg m <sup>2</sup> /A <sup>2</sup> s <sup>2</sup>	degree Celsius	°C (see definition of kelvin)
lumen	lm = cd sr	lux	lx = lm/m <sup>2</sup> = cd sr/m <sup>2</sup>
becquerel	Bq = 1/s	gray	Gy = J/kg = m <sup>2</sup> /s <sup>2</sup>
sievert	Sv = J/kg = m <sup>2</sup> /s <sup>2</sup>	katal	kat = mol/s

We note that in all definitions of units, the kilogram only appears to the powers of 1, 0 and  $-1$ . The final explanation for this fact appeared only recently. Can you try to formulate the reason?

Challenge 637 ny

The *admitted* non-SI units are *minute*, *hour*, *day* (for time), *degree*  $1^\circ = \pi/180$  rad, *minute*  $1' = \pi/10\,800$  rad, *second*  $1'' = \pi/648\,000$  rad (for angles), *litre* and *tonne*. All other units are to be avoided.

All SI units are made more practical by the introduction of standard names and abbreviations for the powers of ten, the so-called *prefixes*.\*

POWER NAME	POWER NAME	POWER NAME	POWER NAME
10 <sup>1</sup> deca da	10 <sup>-1</sup> deci d	10 <sup>18</sup> Exa E	10 <sup>-18</sup> atto a
10 <sup>2</sup> hecto h	10 <sup>-2</sup> centi c	10 <sup>21</sup> Zetta Z	10 <sup>-21</sup> zepto z
10 <sup>3</sup> kilo k	10 <sup>-3</sup> milli m	10 <sup>24</sup> Yotta Y	10 <sup>-24</sup> yocto y
10 <sup>6</sup> Mega M	10 <sup>-6</sup> micro μ	unofficial:	Ref. 325
10 <sup>9</sup> Giga G	10 <sup>-9</sup> nano n	10 <sup>27</sup> Xenta X	10 <sup>-27</sup> xenno x
10 <sup>12</sup> Tera T	10 <sup>-12</sup> pico p	10 <sup>30</sup> Wekta W	10 <sup>-30</sup> weko w
10 <sup>15</sup> Peta P	10 <sup>-15</sup> femto f	10 <sup>33</sup> Vendekta V	10 <sup>-33</sup> vendeko v
		10 <sup>36</sup> Udekta U	10 <sup>-36</sup> udeko u

▪ SI units form a *complete* system: they cover in a systematic way all observables of physics. Moreover, they fix the units of measurement for all other sciences.

\* Some of these names are invented (yocto to sound similar to Latin *octo* 'eight', zepto to sound similar to Latin *septem*, yotta and zetta to resemble them, exa and peta to sound like the Greek words ἑξάκις and πεντάκις for 'six times' and 'five times', the unofficial ones to sound similar to the Greek words for nine, ten, eleven and twelve); some are from Danish/Norwegian (atto from *atten* 'eighteen', femto from *femten* 'fifteen'); some are from Latin (from *mille* 'thousand', from *centum* 'hundred', from *decem* 'ten', from *nanus* 'dwarf'); some are from Italian (from *piccolo* 'small'); some are Greek (micro is from μικρός 'small', deca/deka from δέκα 'ten', hecto from ἑκατόν 'hundred', kilo from χίλιοι 'thousand', mega from μέγας 'large', giga from γίγας 'giant', tera from τέρας 'monster').

Challenge 638 e Translate: I was caught in such a traffic jam that I needed a microcentury for a picoparsec and that my car's fuel consumption was two tenths of a square millimetre.



- SI units form a *universal* system: they can be used in trade, in industry, in commerce, at home, in education and in research. They could even be used by extraterrestrial civilizations, if they existed.

- SI units form a *coherent* system: the product or quotient of two SI units is also an SI unit. This means that in principle, the same abbreviation, e.g. 'SI', could be used for every unit.

The SI units are not the only possible set that could fulfil all these requirements, but they are the only existing system that does so.\*

Challenge 639 e

Since every measurement is a comparison with a standard, any measurement requires *matter* to realize the standard (even for a speed standard), and *radiation* to achieve the comparison. The concept of measurement thus assumes that matter and radiation exist and can be clearly separated from each other.

### CURIOSITIES AND FUN CHALLENGES ABOUT UNITS

Not using SI units can be expensive. In 1999, NASA lost a satellite on Mars because some software programmers had used provincial units instead of SI units in part of the code. As a result, the Mars Climate Orbiter crashed into the planet, instead of orbiting it; the loss was around 100 million euro.\*\*

\* \*

The second does not correspond to 1/86 400th of the day any more, though it did in the year 1900; the Earth now takes about 86 400.002 s for a rotation, so that the *International Earth Rotation Service* must regularly introduce a leap second to ensure that the Sun is at the highest point in the sky at 12 o'clock sharp.\*\*\* The time so defined is called *Universal Time Coordinate*. The speed of rotation of the Earth also changes irregularly from day to day due to the weather; the average rotation speed even changes from winter to summer because of the changes in the polar ice caps; and in addition that average decreases over time, because of the friction produced by the tides. The rate of insertion of leap seconds is therefore higher than once every 500 days, and not constant in time.

\* \*

Ref. 330

Ref. 331

The most precise clock ever built, using microwaves, had a stability of  $10^{-16}$  during a running time of 500 s. For longer time periods, the record in 1997 was about  $10^{-15}$ ; but values around  $10^{-17}$  seem within technological reach. The precision of clocks is limited

\* Apart from international units, there are also *provincial* units. Most provincial units still in use are of Roman origin. The mile comes from *milia passum*, which used to be one thousand (double) strides of about 1480 mm each; today a nautical mile, once defined as minute of arc on the Earth's surface, is exactly 1852 m). The inch comes from *uncia/onzia* (a twelfth – now of a foot). The pound (from *pondere* 'to weigh') is used as a translation of *libra* – balance – which is the origin of its abbreviation lb. Even the habit of counting in dozens instead of tens is Roman in origin. These and all other similarly funny units – like the system in which all units start with 'f', and which uses furlong/fortnight as its unit of velocity – are now officially defined as multiples of SI units.

\*\* This story revived an old (and false) urban legend that states that only three countries in the world do not use SI units: Liberia, the USA and Myanmar.

\*\*\* Their website at [hpiers.obspm.fr](http://hpiers.obspm.fr) gives more information on the details of these insertions, as does [maia.usno.navy.mil](http://maia.usno.navy.mil), one of the few useful military websites. See also [www.bipm.fr](http://www.bipm.fr), the site of the BIPM.

for short measuring times by noise, and for long measuring times by drifts, i.e., by systematic effects. The region of highest stability depends on the clock type; it usually lies between 1 ms for optical clocks and 5000 s for masers. Pulsars are the only type of clock for which this region is not known yet; it certainly lies at more than 20 years, the time elapsed at the time of writing since their discovery.

\* \*

The least precisely measured of the fundamental constants of physics are the gravitational constant  $G$  and the strong coupling constant  $\alpha_s$ . Even less precisely known are the age of the universe and its density (see Table 55).

Page 357

\* \*

The precision of mass measurements of solids is limited by such simple effects as the adsorption of water. Can you estimate the mass of a monolayer of water – a layer with thickness of one molecule – on a metal weight of 1 kg?

Challenge 640 s

\* \*

The Swedish astronomer Anders Celsius (1701–1744) originally set the freezing point of water at 100 degrees and the boiling point at 0 degrees. Later the scale was reversed. However, this is not the whole story. With the official definition of the kelvin and the degree Celsius, at the standard pressure of 1013.25 Pa, water boils at 99.974°C. Can you explain why it is not 100°C any more?

Ref. 332

Challenge 641 s

\* \*

In the previous millennium, thermal energy used to be measured using the unit *calorie*, written as cal. 1 cal is the energy needed to heat 1 g of water by 1 K. To confuse matters, 1 kcal was often written 1 Cal. (One also spoke of a large and a small calorie.) The value of 1 kcal is 4.1868 kJ.

\* \*

SI units are adapted to humans: the values of heartbeat, human size, human weight, human temperature and human substance are no more than a couple of orders of magnitude near the unit value. SI units thus (roughly) confirm what Protagoras said 25 centuries ago: ‘Man is the measure of all things.’

\* \*

Some units systems are particularly badly adapted to humans. The most infamous is shoe size  $S$ . It is a pure number calculated as

$$\begin{aligned} S_{\text{France}} &= 1.5 \text{ cm}^{-1}(l + (1 \pm 1) \text{ cm}) \\ S_{\text{central Europe}} &= 1.5748 \text{ cm}^{-1}(l + (1 \pm 1) \text{ cm}) \\ S_{\text{Anglosaxon men}} &= 1.181 \text{ cm}^{-1}(l + (1 \pm 1) \text{ cm}) - 22 \end{aligned} \quad (116)$$

where  $l$  is the length of a foot and the correction length depends on the manufacturing company. In addition, the Anglosaxon formula is not valid for women and children,

where the first factor depends, for marketing reasons, both on manufacturer and size itself. The ISO standard for shoe size requires, unsurprisingly, to use foot length in millimetres.

\* \*

Challenge 642 s The table of SI prefixes covers 72 orders of magnitude. How many additional prefixes will be needed? Even an extended list will include only a small part of the infinite range of possibilities. Will the Conférence Générale des Poids et Mesures have to go on forever, defining an infinite number of SI prefixes? Why?

\* \*

The French philosopher Voltaire, after meeting Newton, publicized the now famous story that the connection between the fall of objects and the motion of the Moon was discovered by Newton when he saw an apple falling from a tree. More than a century later, just before the French Revolution, a committee of scientists decided to take as the unit of force precisely the force exerted by gravity on a *standard apple*, and to name it after the English scientist. After extensive study, it was found that the mass of the standard apple was 101.9716 g; its weight was called 1 newton. Since then, visitors to the museum in Sèvres near Paris have been able to admire the standard metre, the standard kilogram and the standard apple.\*

#### PRECISION AND ACCURACY OF MEASUREMENTS

Measurements are the basis of physics. Every measurement has an *error*. Errors are due to lack of precision or to lack of accuracy. *Precision* means how well a result is reproduced when the measurement is repeated; *accuracy* is the degree to which a measurement corresponds to the actual value. Lack of precision is due to accidental or *random errors*; they are best measured by the *standard deviation*, usually abbreviated  $\sigma$ ; it is defined through

$$\sigma^2 = \frac{1}{n-1} \sum_{i=1}^n (x_i - \bar{x})^2, \quad (117)$$

Challenge 643 s where  $\bar{x}$  is the average of the measurements  $x_i$ . (Can you imagine why  $n-1$  is used in the formula instead of  $n$ ?)

For most experiments, the distribution of measurement values tends towards a normal distribution, also called *Gaussian distribution*, whenever the number of measurements is increased. The distribution, shown in [Figure 226](#), is described by the expression

$$N(x) \approx e^{-\frac{(x-\bar{x})^2}{2\sigma^2}}. \quad (118)$$

The square  $\sigma^2$  of the standard deviation is also called the *variance*. For a Gaussian distri-

\* To be clear, this is a joke; no standard apple exists. It is *not* a joke however, that owners of several apple trees in Britain and in the US claim descent, by rerooting, from the original tree under which Newton had his insight. DNA tests have even been performed to decide if all these derive from the same tree. The result was, unsurprisingly, that the tree at MIT, in contrast to the British ones, is a fake.

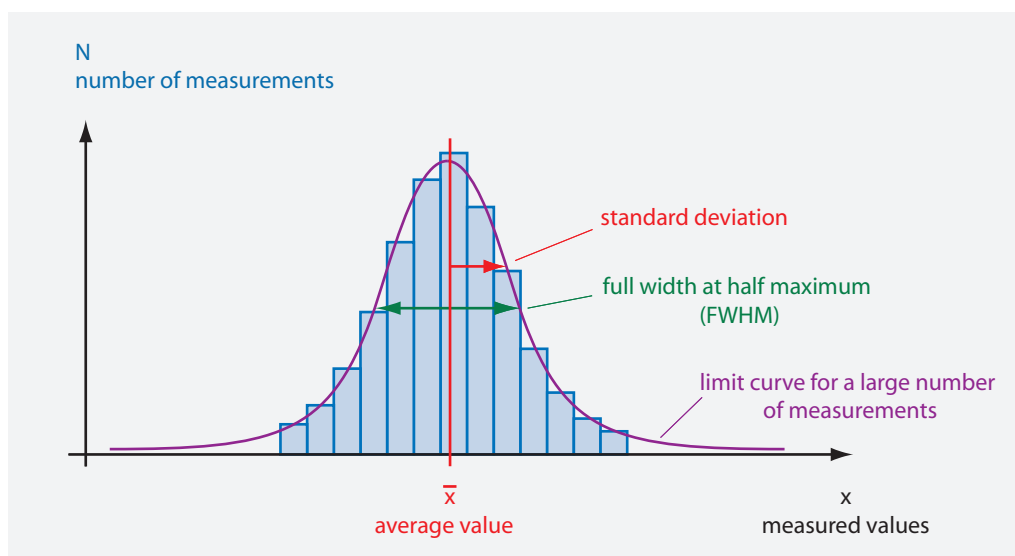


FIGURE 226 A precision experiment and its measurement distribution.

Challenge 644 e

tribution of measurement values,  $2.35\sigma$  is the full width at half maximum.

Ref. 334

Lack of accuracy is due to *systematic errors*; usually these can only be estimated. This estimate is often added to the random errors to produce a *total experimental error*, sometimes also called *total uncertainty*.

Ref. 335

The tables below give the values of the most important physical constants and particle properties in SI units and in a few other common units, as published in the standard references. The values are the world averages of the best measurements made up to the present. As usual, experimental errors, including both random and estimated systematic errors, are expressed by giving the standard deviation in the last digits; e.g.  $0.31(6)$  means – roughly speaking –  $0.31 \pm 0.06$ . In fact, behind each of the numbers in the following tables there is a long story which is worth telling, but for which there is not enough room here.

Ref. 336

### LIMITS TO PRECISION

Challenge 645 e

Vol. VI, page 85

What are the limits to accuracy and precision? There is no way, even in principle, to measure a length  $x$  to a *precision* higher than about 61 digits, because the ratio between the largest and the smallest measurable length is  $\Delta x/x > l_{\text{pl}}/d_{\text{horizon}} = 10^{-61}$ . (Is this ratio valid also for force or for volume?) In the final volume of our text, studies of clocks and metre bars strengthen this theoretical limit.

But it is not difficult to deduce more stringent practical limits. No imaginable machine can measure quantities with a higher precision than measuring the diameter of the Earth within the smallest length ever measured, about  $10^{-19}$  m; that is about 26 digits of precision. Using a more realistic limit of a 1000 m sized machine implies a limit of 22 digits. If, as predicted above, time measurements really achieve 17 digits of precision, then they are nearing the practical limit, because apart from size, there is an additional practical restriction: cost. Indeed, an additional digit in measurement precision often means an

additional digit in equipment cost.

### PHYSICAL CONSTANTS

Ref. 335 In principle, all quantitative properties of matter can be calculated with quantum theory. For example, colour, density and elastic properties can be predicted using the values of the following constants using the equations of the standard model of high-energy physics.

Vol. V, page 190

TABLE 52 Basic physical constants.

QUANTITY	SYMBOL	VALUE IN SI UNITS	UNCERT. <sup>a</sup>
number of space-time dimensions		3 + 1	0 <sup>b</sup>
vacuum speed of light <sup>c</sup>	$c$	299 792 458 m/s	0
vacuum permeability <sup>c</sup>	$\mu_0$	$4\pi \cdot 10^{-7}$ H/m = 1.256 637 061 435 ... $\mu\text{H/m}$	0
vacuum permittivity <sup>c</sup>	$\epsilon_0 = 1/\mu_0 c^2$	8.854 187 817 620 ... pF/m	0
original Planck constant	$h$	$6.626\,068\,76(52) \cdot 10^{-34}$ Js	$7.8 \cdot 10^{-8}$
reduced Planck constant	$\hbar$	$1.054\,571\,596(82) \cdot 10^{-34}$ Js	$7.8 \cdot 10^{-8}$
positron charge	$e$	0.160 217 646 2(63) aC	$3.9 \cdot 10^{-8}$
Boltzmann constant	$k$	$1.380\,650\,3(24) \cdot 10^{-23}$ J/K	$1.7 \cdot 10^{-6}$
gravitational constant	$G$	$6.673(10) \cdot 10^{-11}$ Nm <sup>2</sup> /kg <sup>2</sup>	$1.5 \cdot 10^{-3}$
gravitational coupling constant	$\kappa = 8\pi G/c^4$	$2.076(3) \cdot 10^{-43}$ s <sup>2</sup> /kg m	$1.5 \cdot 10^{-3}$
fine structure constant, <sup>d</sup>	$\alpha = \frac{e^2}{4\pi\epsilon_0\hbar c}$	1/137.035 999 76(50)	$3.7 \cdot 10^{-9}$
e.m. coupling constant	$= g_{\text{em}}(m_e^2 c^2)$	= 0.007 297 352 533(27)	$3.7 \cdot 10^{-9}$
Fermi coupling constant, <sup>d</sup>	$G_{\text{F}}/(\hbar c)^3$	$1.166\,39(1) \cdot 10^{-5}$ GeV <sup>-2</sup>	$8.6 \cdot 10^{-6}$
weak coupling constant	$\alpha_w(M_Z) = g_w^2/4\pi$	1/30.1(3)	$1 \cdot 10^{-2}$
weak mixing angle	$\sin^2 \theta_W(\overline{MS})$	0.231 24(24)	$1.0 \cdot 10^{-3}$
weak mixing angle	$\sin^2 \theta_W$ (on shell) $= 1 - (m_W/m_Z)^2$	0.2224(19)	$8.7 \cdot 10^{-3}$
strong coupling constant <sup>d</sup>	$\alpha_s(M_Z) = g_s^2/4\pi$	0.118(3)	$25 \cdot 10^{-3}$

a. Uncertainty: standard deviation of measurement errors.

b. Only down to  $10^{-19}$  m and up to  $10^{26}$  m.

c. Defining constant.

d. All coupling constants depend on the 4-momentum transfer, as explained in the section on renormalization. *Fine structure constant* is the traditional name for the electromagnetic coupling constant  $g_{\text{em}}$  in the case of a 4-momentum transfer of  $Q^2 = m_e^2 c^2$ , which is the smallest one possible. At higher momentum transfers it has larger values, e.g.  $g_{\text{em}}(Q^2 = M_W^2 c^2) \approx 1/128$ . In contrast, the strong coupling constant has lower values at higher momentum transfers; e.g.,  $\alpha_s(34 \text{ GeV}) = 0.14(2)$ .

Vol. V, page 88

Why do all these constants have the values they have? For any constant *with a dimension*, such as the quantum of action  $\hbar$ , the numerical value has only historical meaning. It is  $1.054 \cdot 10^{-34}$  Js because of the SI definition of the joule and the second. The question why the value of a dimensional constant is not larger or smaller therefore always

requires one to understand the origin of some dimensionless number giving the ratio between the constant and the corresponding natural unit that is defined with  $c$ ,  $G$ ,  $\hbar$  and  $\alpha$ . Understanding the sizes of atoms, people, trees and stars, the duration of molecular and atomic processes, or the mass of nuclei and mountains, implies understanding the ratios between these values and the corresponding natural units. The key to understanding nature is thus the understanding of all ratios, and thus of all dimensionless constants. The quest of understanding all ratios, all dimensionless constants, including the fine structure constant  $\alpha$  itself, is completed only in the final volume of our adventure.

The basic constants yield the following useful high-precision observations.

TABLE 53 Derived physical constants.

Q U A N T I T Y	S Y M B O L	V A L U E I N S I U N I T S	U N C E R T.
Vacuum wave resistance	$Z_0 = \sqrt{\mu_0/\epsilon_0}$	376.730 313 461 77... $\Omega$	0
Avogadro's number	$N_A$	$6.022\,141\,99(47) \cdot 10^{23}$	$7.9 \cdot 10^{-8}$
Rydberg constant <sup>a</sup>	$R_\infty = m_e c \alpha^2 / 2h$	$10\,973\,731.568\,549(83) \text{ m}^{-1}$	$7.6 \cdot 10^{-12}$
conductance quantum	$G_0 = 2e^2/h$	$77.480\,916\,96(28) \mu\text{S}$	$3.7 \cdot 10^{-9}$
magnetic flux quantum	$\varphi_0 = h/2e$	$2.067\,833\,636(81) \text{ pWb}$	$3.9 \cdot 10^{-8}$
Josephson frequency ratio	$2e/h$	$483.597\,898(19) \text{ THz/V}$	$3.9 \cdot 10^{-8}$
von Klitzing constant	$h/e^2 = \mu_0 c / 2\alpha$	$25\,812.807\,572(95) \Omega$	$3.7 \cdot 10^{-9}$
Bohr magneton	$\mu_B = e\hbar/2m_e$	$9.274\,008\,99(37) \text{ yJ/T}$	$4.0 \cdot 10^{-8}$
cyclotron frequency of the electron	$f_c/B = e/2\pi m_e$	$27.992\,4925(11) \text{ GHz/T}$	$4.0 \cdot 10^{-8}$
classical electron radius	$r_e = e^2/4\pi\epsilon_0 m_e c^2$	$2.817\,940\,285(31) \text{ fm}$	$1.1 \cdot 10^{-8}$
Compton wavelength of the electron	$\lambda_c = h/m_e c$ $\lambda_c = \hbar/m_e c = r_e/\alpha$	$2.426\,310\,215(18) \text{ pm}$ $0.386\,159\,264\,2(28) \text{ pm}$	$7.3 \cdot 10^{-9}$ $7.3 \cdot 10^{-9}$
Bohr radius <sup>a</sup>	$a_\infty = r_e/\alpha^2$	$52.917\,720\,83(19) \text{ pm}$	$3.7 \cdot 10^{-9}$
nuclear magneton	$\mu_N = e\hbar/2m_p$	$5.050\,783\,17(20) \cdot 10^{-27} \text{ J/T}$	$4.0 \cdot 10^{-8}$
proton–electron mass ratio	$m_p/m_e$	$1\,836.152\,667\,5(39)$	$2.1 \cdot 10^{-9}$
Stefan–Boltzmann constant	$\sigma = \pi^2 k^4/60\hbar^3 c^2$	$56.704\,00(40) \text{ nW/m}^2\text{K}^4$	$7.0 \cdot 10^{-6}$
Wien's displacement constant	$b = \lambda_{\text{max}} T$	$2.897\,768\,6(51) \text{ mmK}$	$1.7 \cdot 10^{-6}$
bits to entropy conversion const.		$10^{23} \text{ bit} = 0.956\,994\,5(17) \text{ J/K}$	$1.7 \cdot 10^{-6}$
TNT energy content		$3.7 \text{ to } 4.0 \text{ MJ/kg}$	$4 \cdot 10^{-2}$

a. For infinite mass of the nucleus.

Some useful properties of our local environment are given in the following table.

TABLE 54 Astronomical constants.

Q U A N T I T Y	S Y M B O L	V A L U E
tropical year 1900 <sup>a</sup>	$a$	$31\,556\,925.974\,7 \text{ s}$
tropical year 1994	$a$	$31\,556\,925.2 \text{ s}$
mean sidereal day	$d$	$23^{\text{h}}56'4.090\,53''$

TABLE 54 (Continued) Astronomical constants.

Q U A N T I T Y	S Y M B O L	V A L U E
astronomical unit <sup>b</sup>	AU	149 597 870.691(30) km
light year	al	9.460 528 173 ... Pm
parsec	pc	30.856 775 806 Pm = 3.261 634 al
Earth's mass	$M_{\oplus}$	$5.973(1) \cdot 10^{24}$ kg
Geocentric gravitational constant	$GM$	$3.986 004 418(8) \cdot 10^{14}$ m <sup>3</sup> /s <sup>2</sup>
Earth's gravitational length	$l_{\oplus} = 2GM/c^2$	8.870 056 078(16) mm
Earth's equatorial radius <sup>c</sup>	$R_{\oplus\text{eq}}$	6378.1366(1) km
Earth's polar radius <sup>c</sup>	$R_{\oplus\text{p}}$	6356.752(1) km
Equator-pole distance <sup>c</sup>		10 001.966 km (average)
Earth's flattening <sup>c</sup>	$e_{\oplus}$	1/298.25642(1)
Earth's av. density	$\rho_{\oplus}$	5.5 Mg/m <sup>3</sup>
Earth's age	$T_{\oplus}$	4.50(4) Ga = 142(2) Ps
Moon's radius	$R_{\zeta\text{v}}$	1738 km in direction of Earth
Moon's radius	$R_{\zeta\text{h}}$	1737.4 km in other two directions
Moon's mass	$M_{\zeta}$	$7.35 \cdot 10^{22}$ kg
Moon's mean distance <sup>d</sup>	$d_{\zeta}$	384 401 km
Moon's distance at perigee <sup>d</sup>		typically 363 Mm, historical minimum 359 861 km
Moon's distance at apogee <sup>d</sup>		typically 404 Mm, historical maximum 406 720 km
Moon's angular size <sup>e</sup>		average 0.5181° = 31.08', minimum 0.49°, maximum - shortens line 0.55°
Moon's average density	$\rho_{\zeta}$	3.3 Mg/m <sup>3</sup>
Jupiter's mass	$M_{\eta_+}$	$1.90 \cdot 10^{27}$ kg
Jupiter's radius, equatorial	$R_{\eta_+}$	71.398 Mm
Jupiter's radius, polar	$R_{\eta_+}$	67.1(1) Mm
Jupiter's average distance from Sun	$D_{\eta_+}$	778 412 020 km
Sun's mass	$M_{\odot}$	$1.988 43(3) \cdot 10^{30}$ kg
Sun's gravitational length	$l_{\odot} = 2GM_{\odot}/c^2$	2.953 250 08 km
Sun's luminosity	$L_{\odot}$	384.6 YW
Solar equatorial radius	$R_{\odot}$	695.98(7) Mm
Sun's angular size		0.53° average; minimum on fourth of July (aphelion) 1888", maximum on fourth of January (perihelion) 1952"
Sun's average density	$\rho_{\odot}$	1.4 Mg/m <sup>3</sup>
Sun's average distance	AU	149 597 870.691(30) km
Sun's age	$T_{\odot}$	4.6 Ga
Solar velocity	$v_{\odot\text{g}}$	220(20) km/s
around centre of galaxy		
Solar velocity	$v_{\odot\text{b}}$	370.6(5) km/s



TABLE 54 (Continued) Astronomical constants.

Q U A N T I T Y	S Y M B O L	V A L U E
against cosmic background		
Distance to Milky Way's centre		8.0(5) kpc = 26.1(1.6) kal
Milky Way's age		13.6 Ga
Milky Way's size		$c \cdot 10^{21}$ m or 100 kal
Milky Way's mass		$10^{12}$ solar masses, $c \cdot 2 \cdot 10^{42}$ kg
Most distant galaxy cluster known	SXDF-XCLJ 0218-0510	$9.6 \cdot 10^9$ al

Challenge 646 s  
Ref. 337

*a.* Defining constant, from vernal equinox to vernal equinox; it was once used to define the second. (Remember:  $\pi$  seconds is about a nanocentury.) The value for 1990 is about 0.7 s less, corresponding to a slowdown of roughly 0.2 ms/a. (Watch out: why?) There is even an empirical formula for the change of the length of the year over time.

*b.* Average distance Earth–Sun. The truly amazing precision of 30 m results from time averages of signals sent from Viking orbiters and Mars landers taken over a period of over twenty years.

*c.* The shape of the Earth is described most precisely with the World Geodetic System. The last edition dates from 1984. For an extensive presentation of its background and its details, see the [www.wgs84.com](http://www.wgs84.com) website. The International Geodesic Union refined the data in 2000. The radii and the flattening given here are those for the 'mean tide system'. They differ from those of the 'zero tide system' and other systems by about 0.7 m. The details constitute a science in itself.

*d.* Measured centre to centre. To find the precise position of the Moon at a given date, see the [www.fourmilab.ch/earthview/moon\\_ap\\_per.html](http://www.fourmilab.ch/earthview/moon_ap_per.html) page. For the planets, see the page [www.fourmilab.ch/solar/solar.html](http://www.fourmilab.ch/solar/solar.html) and the other pages on the same site.

*e.* Angles are defined as follows: 1 degree =  $1^\circ = \pi/180$  rad, 1 (first) minute =  $1' = 1^\circ/60$ , 1 second (minute) =  $1'' = 1'/60$ . The ancient units 'third minute' and 'fourth minute', each 1/60th of the preceding, are not in use any more. ('Minute' originally means 'very small', as it still does in modern English.)

Challenge 647 s

Some properties of nature at large are listed in the following table. (If you want a challenge, can you determine whether any property of the universe itself is listed?)

TABLE 55 Astrophysical constants.

Q U A N T I T Y	S Y M B O L	V A L U E
gravitational constant	$G$	$6.672\,59(85) \cdot 10^{-11} \text{ m}^3/\text{kg s}^2$
cosmological constant	$\Lambda$	$c \cdot 1 \cdot 10^{-52} \text{ m}^{-2}$
age of the universe <sup>a</sup>	$t_0$	$4.333(53) \cdot 10^{17} \text{ s} = 13.73(0.17) \cdot 10^9 \text{ a}$ (determined from space-time, via expansion, using general relativity)
age of the universe <sup>a</sup>	$t_0$	over $3.5(4) \cdot 10^{17} \text{ s} = 11.5(1.5) \cdot 10^9 \text{ a}$ (determined from matter, via galaxies and stars, using quantum theory)
Hubble parameter <sup>a</sup>	$H_0$	$2.3(2) \cdot 10^{-18} \text{ s}^{-1} = 0.73(4) \cdot 10^{-10} \text{ a}^{-1}$ $= h_0 \cdot 100 \text{ km/s Mpc} = h_0 \cdot 1.0227 \cdot 10^{-10} \text{ a}^{-1}$
reduced Hubble parameter <sup>a</sup>	$h_0$	0.71(4)
deceleration parameter	$q_0 = -(\ddot{a}/a)_0/H_0^2$	-0.66(10)
universe's horizon distance <sup>a</sup>	$d_0 = 3ct_0$	$40.0(6) \cdot 10^{26} \text{ m} = 13.0(2) \text{ Gpc}$

TABLE 55 (Continued) Astrophysical constants.

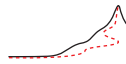
Q U A N T I T Y	S Y M B O L	V A L U E
universe's topology		trivial up to $10^{26}$ m
number of space dimensions		3, for distances up to $10^{26}$ m
critical density of the universe	$\rho_c = 3H_0^2/8\pi G$	$h_0^2 \cdot 1.878\,82(24) \cdot 10^{-26}$ kg/m <sup>3</sup> $= 0.95(12) \cdot 10^{-26}$ kg/m <sup>3</sup>
(total) density parameter <sup>a</sup>	$\Omega_0 = \rho_0/\rho_c$	1.02(2)
baryon density parameter <sup>a</sup>	$\Omega_{B0} = \rho_{B0}/\rho_c$	0.044(4)
cold dark matter density parameter <sup>a</sup>	$\Omega_{CDM0} = \rho_{CDM0}/\rho_c$	0.23(4)
neutrino density parameter <sup>a</sup>	$\Omega_{\nu 0} = \rho_{\nu 0}/\rho_c$	0.001 to 0.05
dark energy density parameter <sup>a</sup>	$\Omega_{X0} = \rho_{X0}/\rho_c$	0.73(4)
dark energy state parameter	$w = p_X/\rho_X$	-1.0(2)
baryon mass	$m_b$	$1.67 \cdot 10^{-27}$ kg
baryon number density		0.25(1)/m <sup>3</sup>
luminous matter density		$3.8(2) \cdot 10^{-28}$ kg/m <sup>3</sup>
stars in the universe	$n_s$	$10^{22\pm 1}$
baryons in the universe	$n_b$	$10^{81\pm 1}$
microwave background temperature <sup>b</sup>	$T_0$	2.725(1) K
photons in the universe	$n_\gamma$	$10^{89}$
photon energy density	$\rho_\gamma = \pi^2 k^4/15T_0^4$	$4.6 \cdot 10^{-31}$ kg/m <sup>3</sup>
photon number density		410.89/cm <sup>3</sup> or 400/cm <sup>3</sup> ( $T_0/2.7$ K) <sup>3</sup>
density perturbation amplitude	$\sqrt{S}$	$5.6(1.5) \cdot 10^{-6}$
gravity wave amplitude	$\sqrt{T}$	$< 0.71\sqrt{S}$
mass fluctuations on 8 Mpc	$\sigma_8$	0.84(4)
scalar index	$n$	0.93(3)
running of scalar index	$dn/d \ln k$	-0.03(2)
Planck length	$l_{Pl} = \sqrt{\hbar G/c^3}$	$1.62 \cdot 10^{-35}$ m
Planck time	$t_{Pl} = \sqrt{\hbar G/c^5}$	$5.39 \cdot 10^{-44}$ s
Planck mass	$m_{Pl} = \sqrt{\hbar c/G}$	21.8 $\mu$ g
instants in history <sup>a</sup>	$t_0/t_{Pl}$	$8.7(2.8) \cdot 10^{60}$
space-time points inside the horizon <sup>a</sup>	$N_0 = (R_0/l_{Pl})^3 \cdot (t_0/t_{Pl})$	$10^{244\pm 1}$
mass inside horizon	$M$	$10^{54\pm 1}$ kg

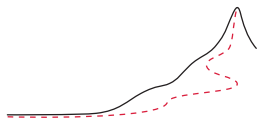
a. The index 0 indicates present-day values.

b. The radiation originated when the universe was 380 000 years old and had a temperature of about 3000 K; the fluctuations  $\Delta T_0$  which led to galaxy formation are today about  $16 \pm 4 \mu\text{K} = 6(2) \cdot 10^{-6} T_0$ .

## USEFUL NUMBERS

$\pi$	3.14159 26535 89793 23846 26433 83279 50288 41971 69399 37510 <sub>5</sub>
$e$	2.71828 18284 59045 23536 02874 71352 66249 77572 47093 69995 <sub>9</sub>
$\gamma$	0.57721 56649 01532 86060 65120 90082 40243 10421 59335 93992 <sub>3</sub>
$\ln 2$	0.69314 71805 59945 30941 72321 21458 17656 80755 00134 36025 <sub>5</sub>
$\ln 10$	2.30258 50929 94045 68401 79914 54684 36420 76011 01488 62877 <sub>2</sub>
$\sqrt{10}$	3.16227 76601 68379 33199 88935 44432 71853 37195 55139 32521 <sub>6</sub>





## APPENDIX C

# SOURCES OF INFORMATION ON MOTION

“No place affords a more striking conviction of the vanity of human hopes than a public library.”  
Samuel Johnson

“In a consumer society there are inevitably two kinds of slaves: the prisoners of addiction and the prisoners of envy.”  
Ivan Illich\*

**I**N the text, good books that introduce neighbouring domains are presented in the bibliography. The bibliography also points to journals and websites, in order to satisfy any additional curiosity about what is encountered in this adventure. All citations can also be found by looking up the author in the name index. To find additional information, either libraries or the internet can help.

In a library, review articles of recent research appear in journals such as *Reviews of Modern Physics*, *Reports on Progress in Physics*, *Contemporary Physics* and *Advances in Physics*. Good pedagogical introductions are found in the *American Journal of Physics*, the *European Journal of Physics* and *Physik in unserer Zeit*.

Overviews on research trends occasionally appear in magazines such as *Physics World*, *Physics Today*, *Europhysics Journal*, *Physik Journal* and *Nederlands tijdschrift voor natuurkunde*. For coverage of all the sciences together, the best sources are the magazines *Nature*, *New Scientist*, *Naturwissenschaften*, *La Recherche* and the cheap but excellent *Science News*.

Research papers appear mainly in *Physics Letters B*, *Nuclear Physics B*, *Physical Review D*, *Physical Review Letters*, *Classical and Quantum Gravity*, *General Relativity and Gravitation*, *International Journal of Modern Physics* and *Modern Physics Letters*. The newest results and speculative ideas are found in conference proceedings, such as the *Nuclear Physics B Supplements*. Research articles also appear in *Fortschritte der Physik*, *Zeitschrift für Physik C*, *La Rivista del Nuovo Cimento*, *Europhysics Letters*, *Communications in Mathematical Physics*, *Journal of Mathematical Physics*, *Foundations of Physics*, *International Journal of Theoretical Physics* and *Journal of Physics G*.

But by far the simplest and most efficient way to keep in touch with ongoing research on motion and modern physics is to use the *internet*, the international computer network. To start using the web, ask a friend who knows.\*\*

\* Ivan Illich (b. 1926 Vienna, d. 2002 Bremen), Austrian theologian and social and political thinker.

\*\* It is also possible to use both the internet and to download files through FTP with the help of email only.

In the last decade of the twentieth century, the internet expanded into a combination of library, media collection, discussion platform, business tool and time waster. Commerce, advertising and – unfortunately – crime of all kind are also an integral part of the web. With a personal computer, a modem and free browser software, one can look for information in millions of pages of documents. The various parts of the documents are located in various computers around the world, but the user does not need to be aware of this.\*

Most theoretical physics papers are available free of charge, as *preprints*, i.e., before official publication and checking by referees, at the [arxiv.org](http://arxiv.org) website. A service for finding subsequent preprints that cite a given one is also available.

There are a few internet physics journals: One is *Living Reviews in Relativity*, found at [www.livingreviews.org](http://www.livingreviews.org), the other is the *New Journal of Physics*, which can be found at the [www.njp.org](http://www.njp.org) website.

On the internet, papers on the description of motion without time and space which appear *after* this text is published can be found via the *Web of Science*, a site accessible only from libraries. It allows one to search for all publications which *cite* a given paper.

Searching the web for authors, organizations, books, publications, companies or simple keywords using search engines can be a rewarding or a time-wasting experience, depending purely on yourself. A selection of interesting servers are given below.

TABLE 56 Some interesting servers on the world-wide web.

TOPIC	WEBSITE ADDRESS
<b>General knowledge</b>	
Wikipedia	<a href="http://www.wikipedia.org">www.wikipedia.org</a>
Usenet discssions	<a href="http://groups.google.com">groups.google.com</a>

But the tools change too often to give a stable guide here. Ask your friend.

\* Several decades ago, the provocative book by IVAN ILLICH, *Deschooling Society*, Harper & Row, 1971, listed four basic ingredients for any educational system:

1. access to *resources* for learning, e.g. books, equipment, games, etc. at an affordable price, for everybody, at any time in their life;
2. for all who want to learn, access to *peers* in the same learning situation, for discussion, comparison, cooperation and competition;
3. access to *elders*, e.g. teachers, for their care and criticism towards those who are learning;
4. exchanges between students and *performers* in the field of interest, so that the latter can be models for the former. For example, there should be the possibility to listen to professional musicians and reading the works of specialist writers. This also gives performers the possibility to share, advertise and use their skills.

Illich develops the idea that if such a system were informal – he then calls it a ‘learning web’ or ‘opportunity web’ – it would be superior to formal, state-financed institutions, such as conventional schools, for the development of mature human beings. These ideas are deepened in his following works, *Deschooling Our Lives*, Penguin, 1976, and *Tools for Conviviality*, Penguin, 1973.

Today, any networked computer offers *email* (electronic mail), FTP (file transfer to and from another computer), access to *usenet* (the discussion groups on specific topics, such as particle physics), and the *world-wide web*. (Roughly speaking, each of those includes the ones before.) In a rather unexpected way, all these facilities of the internet have transformed it into the backbone of the ‘opportunity web’ discussed by Illich. However, as in any school, it strongly depends on the user’s discipline whether the internet actually does provide a learning web.

TOPIC	WEBSITE ADDRESS
Frequently asked questions on physics and other topics	<a href="http://www.faqs.org">www.faqs.org</a>
Book collections	<a href="http://www.ulib.org">www.ulib.org</a> <a href="http://books.google.com">books.google.com</a>
<b>Physics</b>	
Research preprints	<a href="http://arxiv.org">arxiv.org</a> <a href="http://www.slac.stanford.edu/spires">www.slac.stanford.edu/spires</a>
Particle data	<a href="http://pdg.web.cern.ch">pdg.web.cern.ch</a>
Physics news, weekly	<a href="http://www.aip.org/physnews/update">www.aip.org/physnews/update</a>
Physics news, daily	<a href="http://www.innovations-report.de/berichte/physik.php">www.innovations-report.de/berichte/physik.php</a>
Physics problems by Yakov Kantor	<a href="http://star.tau.ac.il/QUIZ">star.tau.ac.il/QUIZ</a>
Physics problems by Henry Greenside	<a href="http://www.phy.duke.edu/~hsg/physics-challenges/challenges.html">www.phy.duke.edu/~hsg/physics-challenges/challenges.html</a>
Physics 'question of the week'	<a href="http://www.physics.umd.edu/lecdem/outreach/QOTW/active">www.physics.umd.edu/lecdem/outreach/QOTW/active</a>
Physics 'miniproblem'	<a href="http://www.nyteknik.se/miniproblemet">www.nyteknik.se/miniproblemet</a>
Official SI unit website	<a href="http://www.bipm.fr">www.bipm.fr</a>
Unit conversion	<a href="http://www.chemie.fu-berlin.de/chemistry/general/units.html">www.chemie.fu-berlin.de/chemistry/general/units.html</a>
'Ask the experts'	<a href="http://www.sciam.com/askexpert_directory.cfm">www.sciam.com/askexpert_directory.cfm</a>
Abstracts of papers in physics journals	<a href="http://www.osti.gov">www.osti.gov</a>
<i>Science News</i>	<a href="http://www.sciencenews.org">www.sciencenews.org</a>
Nobel Prize winners	<a href="http://www.nobel.se/physics/laureates">www.nobel.se/physics/laureates</a>
Pictures of physicists	<a href="http://www.if.ufrj.br/famous/physlist.html">www.if.ufrj.br/famous/physlist.html</a>
<i>Living Reviews in Relativity</i>	<a href="http://www.livingreviews.org">www.livingreviews.org</a>
Information on relativity	<a href="http://math.ucr.edu/home/baez/relativity.html">math.ucr.edu/home/baez/relativity.html</a>
Physics organizations	<a href="http://www.cern.ch">www.cern.ch</a> <a href="http://www.hep.net">www.hep.net</a> <a href="http://www.nikhef.nl">www.nikhef.nl</a> <a href="http://www.het.brown.edu/physics/review/index.html">www.het.brown.edu/physics/review/index.html</a>
Physics textbooks on the web	<a href="http://www.plasma.uu.se/CED/Book">www.plasma.uu.se/CED/Book</a> <a href="http://www.biophysics.org/education/resources.htm">www.biophysics.org/education/resources.htm</a> <a href="http://www.lightandmatter.com">www.lightandmatter.com</a> <a href="http://www.motionmountain.net">www.motionmountain.net</a>
Three beautiful French sets of notes on classical mechanics and particle theory	<a href="http://feynman.phy.ulaval.ca/marleau/notesdecours.htm">feynman.phy.ulaval.ca/marleau/notesdecours.htm</a>
The excellent <i>Radical Freshman Physics</i> by David Raymond	<a href="http://www.physics.nmt.edu/~raymond/teaching.html">www.physics.nmt.edu/~raymond/teaching.html</a>
Physics course scripts from MIT	<a href="http://ocw.mit.edu/OcwWeb/Physics/index.html">ocw.mit.edu/OcwWeb/Physics/index.html</a>

TOPIC	WEBSITE ADDRESS
Physics lecture scripts in German and English	<a href="http://www.akleon.de">www.akleon.de</a>
'World lecture hall'	<a href="http://www.utexas.edu/world/lecture">www.utexas.edu/world/lecture</a>
Engineering data and formulae	<a href="http://www.efunda.com">www.efunda.com</a>
Wissenschaft in die Schulen	<a href="http://www.wissenschaft-schulen.de">www.wissenschaft-schulen.de</a>
Discussions	<a href="http://www.physicsforums.com">www.physicsforums.com</a>
<b>Mathematics</b>	
'Math forum' internet resource collection	<a href="http://mathforum.org/library">mathforum.org/library</a>
Biographies of mathematicians	<a href="http://www-history.mcs.st-andrews.ac.uk/BiogIndex.html">www-history.mcs.st-andrews.ac.uk/BiogIndex.html</a>
Purdue math problem of the week	<a href="http://www.math.purdue.edu/academics/pow">www.math.purdue.edu/academics/pow</a>
Macalester College maths problem of the week	<a href="http://mathforum.org/wagon">mathforum.org/wagon</a>
Mathematical formulae	<a href="http://dlmf.nist.gov">dlmf.nist.gov</a>
Functions	<a href="http://functions.wolfram.com">functions.wolfram.com</a>
Symbolic integration	<a href="http://www.integrals.com">www.integrals.com</a>
Weisstein's World of Mathematics	<a href="http://mathworld.wolfram.com">mathworld.wolfram.com</a>
<b>Curiosities</b>	
<b>Minerals</b>	
	<a href="http://webmineral.com">webmineral.com</a>
	<a href="http://www.mindat.org">www.mindat.org</a>
<b>Geological Maps</b>	
ESA	<a href="http://sci.esa.int">sci.esa.int</a>
NASA	<a href="http://www.nasa.gov">www.nasa.gov</a>
Hubble space telescope	<a href="http://hubble.nasa.gov">hubble.nasa.gov</a>
Sloan Digital Sky Survey	<a href="http://skyserver.sdss.org">skyserver.sdss.org</a>
The 'cosmic mirror'	<a href="http://www.astro.uni-bonn.de/~dfischer/mirror">www.astro.uni-bonn.de/~dfischer/mirror</a>
Solar system simulator	<a href="http://space.jpl.nasa.gov">space.jpl.nasa.gov</a>
Observable satellites	<a href="http://liftoff.msfc.nasa.gov/RealTime/JPass/20">liftoff.msfc.nasa.gov/RealTime/JPass/20</a>
Astronomy picture of the day	<a href="http://antwrp.gsfc.nasa.gov/apod/astropix.html">antwrp.gsfc.nasa.gov/apod/astropix.html</a>
The Earth from space	<a href="http://www.visibleearth.nasa.gov">www.visibleearth.nasa.gov</a>
From Stargazers to Starships	<a href="http://www.phy6.org/stargaze/Sintro.htm">www.phy6.org/stargaze/Sintro.htm</a>
Current solar data	<a href="http://www.n3kl.org/sun">www.n3kl.org/sun</a>
Optical illusions	<a href="http://www.sandlotscience.com">www.sandlotscience.com</a>
Petit's science comics	<a href="http://www.jp-petit.org">www.jp-petit.org</a>
Physical toys	<a href="http://www.e20.physik.tu-muenchen.de/~cucke/toylinke.htm">www.e20.physik.tu-muenchen.de/~cucke/toylinke.htm</a>
Physics humour	<a href="http://www.dctech.com/physics/humor/biglist.php">www.dctech.com/physics/humor/biglist.php</a>
Literature on magic	<a href="http://www.faqs.org/faqs/magic-faq/part2">www.faqs.org/faqs/magic-faq/part2</a>
Algebraic surfaces	<a href="http://www.mathematik.uni-kl.de/~hunt/drawings.html">www.mathematik.uni-kl.de/~hunt/drawings.html</a>

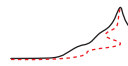


TOPIC	WEBSITE ADDRESS
Making paper aeroplanes	<a href="http://www.pchelp.net/paper_ac.htm">www.pchelp.net/paper_ac.htm</a>
	<a href="http://www.ivic.qc.ca/~aleexpert/aluniversite/klinevogelmann.html">www.ivic.qc.ca/~aleexpert/aluniversite/klinevogelmann.html</a>
Small flying helicopters	<a href="http://pixelito.reference.be">pixelito.reference.be</a>
Ten thousand year clock	<a href="http://www.longnow.org">www.longnow.org</a>
Gesellschaft Deutscher Naturforscher und Ärzte	<a href="http://www.gdnae.de">www.gdnae.de</a>
Pseudoscience	<a href="http://suhp.phy.syr.edu/courses/modules/PSEUDO/pseudo_main.html">suhp.phy.syr.edu/courses/modules/PSEUDO/pseudo_main.html</a>
Crackpots	<a href="http://www.crank.net">www.crank.net</a>
Mathematical quotations	<a href="http://math.furman.edu/mwoodard/~mquot.html">math.furman.edu/mwoodard/~mquot.html</a>
The 'World Question Center'	<a href="http://www.edge.org/questioncenter.html">www.edge.org/questioncenter.html</a>
Plagiarism	<a href="http://www.plagiarized.com">www.plagiarized.com</a>
Hoaxes	<a href="http://www.museumofhoaxes.com">www.museumofhoaxes.com</a>

Do you want to study physics without actually going to university? Nowadays it is possible to do so via email and internet, in German, at the University of Kaiserslautern.\* In the near future, a nationwide project in Britain should allow the same for English-speaking students. As an introduction, use the latest update of this physics text!

“Das Internet ist die offenste Form der geschlossenen Anstalt.\*\*”  
Matthias Deutschmann

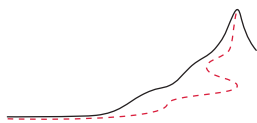
“Si tacuisses, philosophus mansisses.\*\*\*”  
After Boethius.



\* See the [www.fernstudium-physik.de](http://www.fernstudium-physik.de) website.

\*\* ‘The internet is the most open form of a closed institution.’

\*\*\* ‘If you had kept quiet, you would have remained a philosopher.’ After the story Boethius tells in *De consolatione philosophiae*, 2.7, 67 ff.



## CHALLENGE HINTS AND SOLUTIONS

“Never make a calculation before you know the answer.”

John Wheeler's motto

John Wheeler wanted people to estimate, to try and to guess; but not saying the guess out loud. A correct guess reinforces the physics instinct, whereas a wrong one leads to the pleasure of surprise. Guessing is thus an important first step in solving every problem.

**Challenge 1**, page 9: Do not hesitate to be demanding and strict. The next edition of the text will benefit from it.

**Challenge 2**, page 15: There are many ways to distinguish real motion from an illusion of motion: for example, only real motion can be used to set something else into motion. In addition, the motion illusions of the figures show an important failure; nothing moves if the head and the paper remain fixed with respect to each other. In other words, the illusion only *amplifies* existing motion, it does not *create* motion from nothing.

**Challenge 3**, page 16: Without detailed and precise experiments, both sides can find examples to prove their point. Creation is supported by the appearance of mould or bacteria in a glass of water; creation is also supported by its opposite, namely traceless disappearance, such as the disappearance of motion. However, conservation is supported and creation falsified by all those investigations that explore assumed cases of appearance or disappearance in full detail.

**Challenge 4**, page 18: The amount of water depends on the shape of the bucket. The system chooses the option (tilt or straght) for which the centre of gravity is lowest.

**Challenge 5**, page 18: Political parties, sects, helping organizations and therapists of all kinds are typical for this behaviour.

**Challenge 6**, page 22: The issue is not yet completely settled for the motion of empty space, such as in the case of gravitational waves. Thus, the motion of empty space might be an exception. In any case, empty space is not made of small particles of finite size, as this would contradict the transversality of gravity waves.

**Challenge 7**, page 25: The circular definition is: objects are defined as what moves with respect to the background, and the background is defined as what stays when objects change. We shall return to this important issue several times in our adventure. It will require a certain amount of patience to solve it, though.

**Challenge 8**, page 26: Holes are not physical systems, because in general they cannot be tracked.

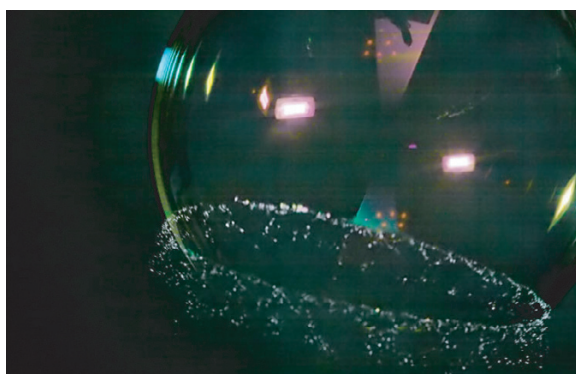
**Challenge 9**, page 26: See the discussion in volume IV, on quantum theory.

**Challenge 10**, page 28: Hint: yes, there is such a point.

**Challenge 11**, page 28: See [Figure 227](#) for an intermediate step. A bubble bursts at a point, and then the rim of the hole increases rapidly, until it disappears on the antipodes. During that pro-

Page 334

Vol. IV, page 142



**FIGURE 227** A soap bubble while bursting  
(© Peter Wienerroither).

cess the remaining of the bubble keeps its spherical shape, as shown in the figure. For a film of the process, see [www.youtube.com/watch?v=SpcXtmkk26Q](http://www.youtube.com/watch?v=SpcXtmkk26Q). In other words, the final droplets that are ejected stem from the point of the bubble which is opposite to the point of puncture; they are never ejected from the centre of the bubble.

Vol. IV, page 112

**Challenge 12**, page 28: A ghost can be a moving image; it cannot be a moving object, as objects cannot interpenetrate.

**Challenge 13**, page 29: If something could stop moving, motion could disappear into nothing. For a precise proof, one would have to show that no atom moves any more. So far, this has never been observed: motion is conserved. (Nothing in nature can disappear into nothing.)

**Challenge 14**, page 29: This would indeed mean that space is infinite; however, it is impossible to observe that something moves “forever”: nobody lives that long. In short, there is no way to prove that space is infinite in this way. In fact, there is no way to prove that space is infinite in any other way either.

**Challenge 15**, page 29: The necessary rope length is  $nh$ , where  $n$  is the number of wheels/pulleys. And yes, the farmer is indeed doing something sensible.

**Challenge 16**, page 29: How would you measure this?

**Challenge 17**, page 29: The number of reliable digits of a measurement result is a simple quantification of precision. More details can be found by looking up ‘standard deviation’ in the index.

**Challenge 18**, page 29: No; memory is needed for observation and measurements. This is the case for humans and measurement apparatus. Quantum theory will make this particularly clear.

**Challenge 19**, page 29: Note that you never have observed zero speed. There is always some measurement error which prevents one to say that something is zero. No exceptions!

**Challenge 20**, page 29:  $(2^{64} - 1) = 18\,446\,744\,073\,700\,551\,615$  grains of wheat, with a grain weight of 40 mg, are 738 thousand million tons. Given a world harvest in 2006 of 606 million tons, the grains amount to about 1200 years of the world’s wheat harvests.

The grain number calculation is simplified by using the formula  $1 + m + m^2 + m^3 + \dots + m^n = (m^{n+1} - 1)/(m - 1)$ , that gives the sum of the so-called *geometric sequence*. (The name is historical and is used as a contrast to the *arithmetic sequence*  $1 + 2 + 3 + 4 + 5 + \dots + n = n(n + 1)/2$ .) Can you prove the two expressions?

The chess legend is mentioned first by Abu-l’Abbas Ahmand Ibn Khallikan (1211–1282).. King Shiram and king Balhait, also mentioned in the legend, are historical figures that lived between the second and fourth century CE. The legend appears to have combined two different stories. Indeed, the calculation of grains appears already in the year 947, in the famous text *Meadows of*

*Gold and Mines of Precious Stones* by Abu ul-Hasan 'Ali ibn Husayn ibn 'Ali ul-Mas'udi.

**Challenge 21**, page 29: In clean experiments, the flame leans inwards. But such experiments are not easy, and sometimes the flame leans outwards. Just try it. Can you explain both observations?

**Challenge 22**, page 29: Accelerometers are the simplest motion detectors. They exist in form of piezoelectric devices that produce a signal whenever the box is accelerated and can cost as little as one euro. Another accelerometer that might have a future is an interference accelerometer that makes use of the motion of an interference grating; this device might be integrated in silicon. Other, more precise accelerometers use gyroscopes or laser beams running in circles.

Velocimeters and position detectors can also detect motion; they need a wheel or at least an optical way to look out of the box. Tachographs in cars are examples of velocimeters, computer mice are examples of position detectors.

A cheap enough device would be perfect to measure the speed of skiers or skaters. No such device exists yet.

**Challenge 23**, page 29: The ball rolls (or slides) towards the centre of the table, as the table centre is somewhat nearer to the centre of the Earth than the border; then the ball shoots over, performing an oscillation around the table centre. The period is 84 min, as shown in challenge 351. (This has never been observed, so far. Why?)

**Challenge 24**, page 30: Only if the acceleration never vanishes. Accelerations can be felt. Accelerometers are devices that measure accelerations and then deduce the position. They are used in aeroplanes when flying over the atlantic. If the box does not accelerate, it is impossible to say whether it moves or sits still. It is even impossible to say in which direction one moves. (Close your eyes in a train at night to confirm this.)

**Challenge 25**, page 30: The block moves twice as fast as the cylinders, independently of their radius.

**Challenge 26**, page 30: This methods is known to work with other fears as well.

**Challenge 27**, page 30: Three couples require 11 passages. Two couples require 5. For four or more couples there is no solution. What is the solution if there are  $n$  couples and  $n - 1$  places on the boat?

**Challenge 28**, page 31: Hint: there is an infinite number of such shapes. These curves are called also *Reuleaux curves*. Another hint: The 20 p and 50 p coins in the UK have such shapes. And yes, other shapes than cylinders are also possible: take a twisted square cylinder, for example.

**Challenge 29**, page 31: Conservation, relativity and minimization are valid generally. In some rare processes in nuclear physics, motion invariance is broke, as is mirror invariance. Continuity is known not to be valid at smallest length and time intervals, but no experiments has yet probed those domains, so that it is still valid in practice.

**Challenge 30**, page 32: In everyday life, this is correct; what happens when quantum effects are taken into account?

**Challenge 31**, page 34: Take the average distance change of two neighbouring atoms in a piece of quartz over the last million years. Do you know something still slower?

**Challenge 32**, page 35: There is only one way: compare the velocity to be measured with the speed of light. In fact, almost all physics textbooks, both for schools and for university, start with the definition of space and time. Otherwise excellent relativity textbooks have difficulties avoiding this habit, even those that introduce the now standard k-calculus (which is in fact the approach mentioned here). Starting with speed is the logically cleanest approach.

**Challenge 33**, page 35: There is no way to sense one's own motion if one is in vacuum. No way in principle. This result is often called the *principle of relativity*.



**FIGURE 228** Sunbeams in a forest  
(© Fritz Bieri and Heinz Rieder).

In fact, there is a way to measure one's motion in space (though not in vacuum): measure your speed with respect to the background radiation. So one has to be careful about what is meant.

**Challenge 34**, page 35: The wing load  $W/A$ , the ratio between weight  $W$  and wing area  $A$ , is obviously proportional to the third root of the weight. (Indeed,  $W \sim l^3$ ,  $A \sim l^2$ ,  $l$  being the dimension of the flying object.) This relation gives the green trend line.

The wing load  $W/A$ , the ratio between weight  $W$  and wing area  $A$ , is, like all forces in fluids, proportional to the square of the cruise speed  $v$ : we have  $W/A = v^2 0.38 \text{ kg/m}^3$ . The unexplained factor contains the density of air and a general numerical coefficient that is difficult to calculate. This relation connects the upper and lower horizontal scales in the graph.

As a result, the cruise speed scales as the *sixth root* of weight:  $v \sim W^{1/6}$ . In other words, an Airbus A380 is 750 000 million times heavier than a fruit fly, but only a hundred times as fast.

Vol. VI, page 58

**Challenge 35**, page 39: Equivalently: do points in space exist? The final part of our ascent studies this issue in detail.

**Challenge 36**, page 40: All electricity sources must use the same phase when they feed electric power into the net. Clocks of computers on the internet must be synchronized.

**Challenge 37**, page 40: Note that the shift increases quadratically with time, not linearly.

**Challenge 38**, page 40: Natural time is measured with natural motion. Natural motion is the motion of light. Natural time is thus defined with the motion of light.

**Challenge 39**, page 41: Galileo measured time with a scale (and with other methods). His stopwatch was a water tube that he kept closed with his thumb, pointing into a bucket. To start the stopwatch, he removed his thumb, to stop it, he put it back on. The volume of water in the bucket then gave him a measure of the time interval. This is told in his famous book GALILEO GALILEI, *Discorsi e dimostrazioni matematiche intorno a due nuove scienze attenenti alla meccanica e i movimenti locali*, usually simply called the 'Discorsi', which he published in 1638 with Louis Elsevier in Leiden, in the Netherlands.

**Challenge 40**, page 44: There is no way to define a local time at the poles that is consistent with all neighbouring points. (For curious people, check the website [www.arctic.noaa.gov/gallery\\_np.html](http://www.arctic.noaa.gov/gallery_np.html).)

**Challenge 42**, page 46: The forest is full of light and thus of light rays: they are straight, as shown by the sunbeams in **Figure 228**.

**Challenge 43**, page 47: One pair of muscles moves the lens along the third axis by deforming the eye from prolate to spherical to oblate.

**Challenge 44**, page 47: This you can solve trying to think in four dimensions. Try to imagine how to switch the sequence when two pieces cross. Note: it is usually *not* correct, in this domain, to use time instead of a fourth *spatial* dimension!

**Challenge 45**, page 48: Measure distances using light.

**Challenge 48**, page 52: It is easier to work with the unit torus. Take the unit interval  $[0, 1]$  and equate the end points. Define a set  $B$  in which the elements are a given real number  $b$  from the interval plus all those numbers who differ from that real by a rational number. The unit circle can be thought as the union of all the sets  $B$ . (In fact, every set  $B$  is a shifted copy of the rational numbers  $\mathbb{Q}$ .) Now build a set  $A$  by taking one element from each set  $B$ . Then build the set family consisting of the set  $A$  and its copies  $A_q$  shifted by a rational  $q$ . The union of all these sets is the unit torus. The set family is countably infinite. Then divide it into *two* countably infinite set families. It is easy to see that each of the two families can be renumbered and its elements shifted in such a way that each of the two families forms a unit torus.

Ref. 41 Mathematicians say that there is no countably infinitely additive measure of  $\mathbb{R}^n$  or that sets such as  $A$  are non-measurable. As a result of their existence, the ‘multiplication’ of lengths is possible. Later on we shall explore whether bread or *gold* can be multiplied in this way.

**Challenge 49**, page 52: Hint: start with triangles.

**Challenge 50**, page 52: An example is the region between the x-axis and the function which assigns 1 to every transcendental and 0 to every non-transcendental number.

**Challenge 51**, page 53: We use the definition of the function of the text. The dihedral angle of a regular tetrahedron is an irrational multiple of  $\pi$ , so the tetrahedron has a non-vanishing Dehn invariant. The cube has a dihedral angle of  $\pi/2$ , so the Dehn invariant of the cube is 0. Therefore, the cube is not equidecomposable with the regular tetrahedron.

**Challenge 52**, page 54: If you think you can show that empty space is continuous, you are wrong. Check your arguments. If you think you can prove the opposite, you *might* be right – but only if you already know what is explained in the final part of the text. If that is not the case, check your arguments.

**Challenge 53**, page 55: Obviously, we use light to check that the plumb line is straight, so the two definitions must be the same. This is the case because the field lines of gravity are also possible paths for the motion of light. However, this is not always the case; can you spot the exceptions?

Another way to check straightness is along the surface of calm water.

A third, less precise way, way is to make use of the straightness sensors on the brain. The human brain has a built-in faculty to determine whether an objects seen with the eyes is straight. There are special cells in the brain that fore when this is the case. Any book on vision perception tells more about this topic.

**Challenge 54**, page 55: The hollow Earth theory is correct if the distance formula is used consistently. In particular, one has to make the assumption that objects get smaller as they approach the centre of the hollow sphere. Good explanations of all events are found on [www.geocities.com/inversedearth](http://www.geocities.com/inversedearth). Quite some material can be found on the internet, also under the names of celestrocetric system, inner world theory or concave Earth theory. There is no way to prefer one description over the other, except possibly for reasons of simplicity or intellectual laziness.

**Challenge 56**, page 56: A hint is given in [Figure 229](#). For the measurement of the speed of light with almost the same method, see [page 18](#).

**Challenge 57**, page 56: A fast motorbike is faster: a driver can catch an arrow, a stunt that was shown on a television show in Germany around the year 2000.



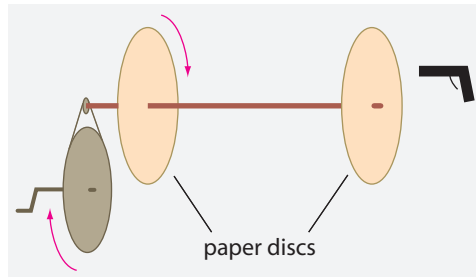


FIGURE 229 A simple way to measure bullet speeds.

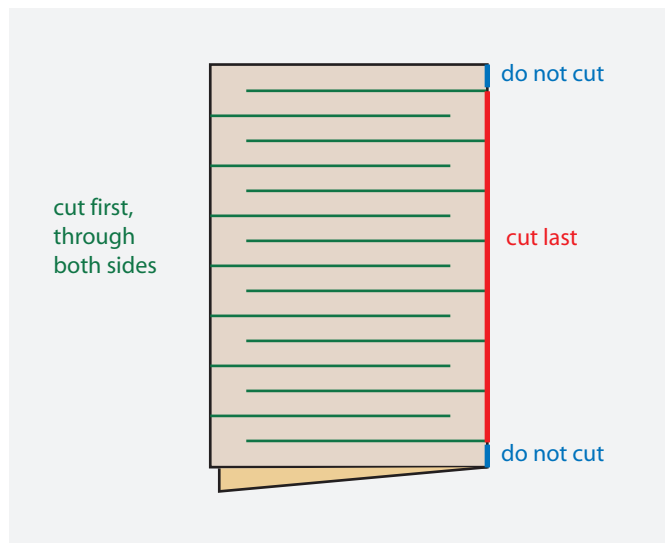


FIGURE 230 How to make a hole in a postcard that allows stepping through it.

**Challenge 58**, page 56: 72 stairs.

**Challenge 61**, page 57: See Figure 230.

**Challenge 62**, page 57: Within 1 per cent, one *fifth* of the height must be empty, and four fifths must be filled; the exact value follows from  $\sqrt[3]{2} = 1.25992\dots$

**Challenge 63**, page 57: One pencil draws a line of between 20 and 80 km, if no lead is lost when sharpening. Numbers for the newly invented plastic, flexible pencils are unknown.

**Challenge 64**, page 57: The bear is white, because the obvious spot of the house is at the North pole. But there are infinitely many additional spots (without bears) near the South pole: can you find them?

**Challenge 65**, page 57: We call  $L$  the initial length of the rubber band,  $v$  the speed of the snail relative to the band and  $V$  the speed of the horse relative to the floor. The speed of the snail relative to the floor is given as

$$\frac{ds}{dt} = v + V \frac{s}{L + Vt} . \quad (119)$$

This is a so-called *differential equation* for the unknown snail position  $s(t)$ . You can check – by simple insertion – that its solution is given by

$$s(t) = \frac{v}{V} (L + Vt) \ln(1 + Vt/L) . \quad (120)$$



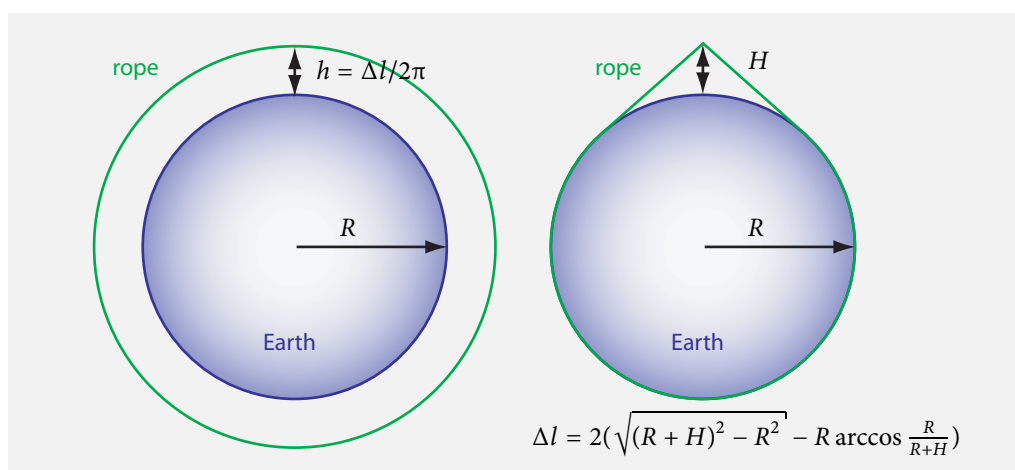


FIGURE 231 Two ways to lengthen a rope around the Earth.

Therefore, the snail reaches the horse at a time

$$t_{\text{reaching}} = \frac{L}{V}(e^{V/v} - 1) \quad (121)$$

which is finite for all values of  $L$ ,  $V$  and  $v$ . You can check however, that the time is very large indeed, if realistic speed values are used.

**Challenge 66**, page 58: Colour is a property that applies only to objects, not to boundaries. The question shows that it is easy to ask questions that make no sense also in physics.

**Challenge 67**, page 58: You can do this easily yourself. You can even find websites on the topic.

**Challenge 69**, page 58: Clocks with two hands: 22 times. Clocks with three hands: 2 times.

**Challenge 70**, page 58: For two hands, the answer is 143 times.

**Challenge 71**, page 58: The Earth rotates with 15 minutes per minute.

**Challenge 72**, page 58: You might be astonished, but no reliable data exist on this question. The highest speed of a throw measured so far seems to be a 45 m/s cricket bowl. By the way, much more data are available for speeds achieved with the help of rackets. The  $c. 70$  m/s of fast badminton smashes seem to be a good candidate for record racket speed; similar speeds are achieved by golf balls.

**Challenge 73**, page 59: A *spread out* lengthening by 1 m allows even many cats to slip through, as shown on the left side of Figure 231. But the right side of the figure shows a better way to use the extra rope length, as Dimitri Yatsenko points out: a *localized* lengthening by 1 mm then already yields a height of 1.25 m, allowing many children to walk through. In fact, a lengthening by 1 m performed in this way yields a peak height of 121 m!

**Challenge 74**, page 59: 1.8 km/h or 0.5 m/s.

**Challenge 76**, page 59: The different usage reflects the idea that we are able to determine our position by ourselves, but not the time in which we are. The section on determinism will show how wrong this distinction is.

**Challenge 77**, page 59: Yes, there is. However, this is not obvious, as it implies that space and time are not continuous, in contrast to what we learn in primary school. The answer will be found in the final part of this text.

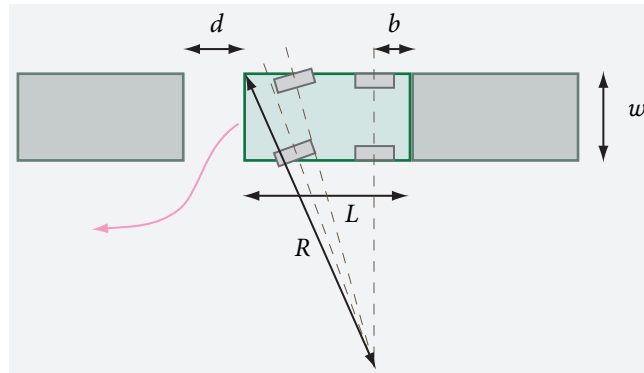


FIGURE 232 Leaving a parking space – the outer turning radius.

**Challenge 78**, page 59: For a curve, use, at each point, the curvature radius of the circle approximating the curve in that point; for a surface, define two directions in each point and use two such circles along these directions.

**Challenge 79**, page 59: It moves about 1 cm in 50 ms.

**Challenge 80**, page 59: The surface area of the lung is between 100 and 200 m<sup>2</sup>, depending on the literature source, and that of the intestines is between 200 and 400 m<sup>2</sup>.

**Challenge 81**, page 60: A limit does not exist in classical physics; however, there is one in nature which appears as soon as quantum effects are taken into account.

**Challenge 82**, page 60: The final shape is a full cube without any hole.

**Challenge 83**, page 60: The required gap  $d$  is

$$d = \sqrt{(L - b)^2 - w^2 + 2w\sqrt{R^2 - (L - b)^2}} - L + b, \quad (122)$$

as deduced from Figure 232.

**Challenge 84**, page 60: A smallest gap does not exist: any value will do! Can you show this?

**Challenge 85**, page 60: The following solution was proposed by Daniel Hawkins.

Assume you are sitting in car A, parked behind car B, as shown in Figure 233. There are two basic methods for exiting a parking space that requires the reverse gear: rotating the car to move the centre of rotation away from (to the right of) car B, and shifting the car downward to move the centre of rotation away from (farther below) car B. The first method requires car A to be partially diagonal, which means that the method will not work for  $d$  less than a certain value, essentially the value given above, when no reverse gear is needed. We will concern ourselves with the second method (pictured), which will work for an infinitesimal  $d$ .

In the case where the distance  $d$  is less than the minimum required distance to turn out of the parking space without using the reverse gear for a given geometry  $L, w, b, R$ , an attempt to turn out of the parking space will result in the corner of car A touching car B at a distance  $T$  away from the edge of car B, as shown in Figure 233. This distance  $T$  is the amount by which car A must be translated downward in order to successfully turn out of the parking space.

The method to leave the parking space, shown in the top left corner of Figure 233, requires two phases to be successful: the initial turning phase, and the straightening phase. By turning and straightening out, we achieve a vertical shift downward and a horizontal shift left, while preserving the original orientation. That last part is key because if we attempted to turn until the corner of car A touched car B, car A would be rotated, and any attempt to straighten out

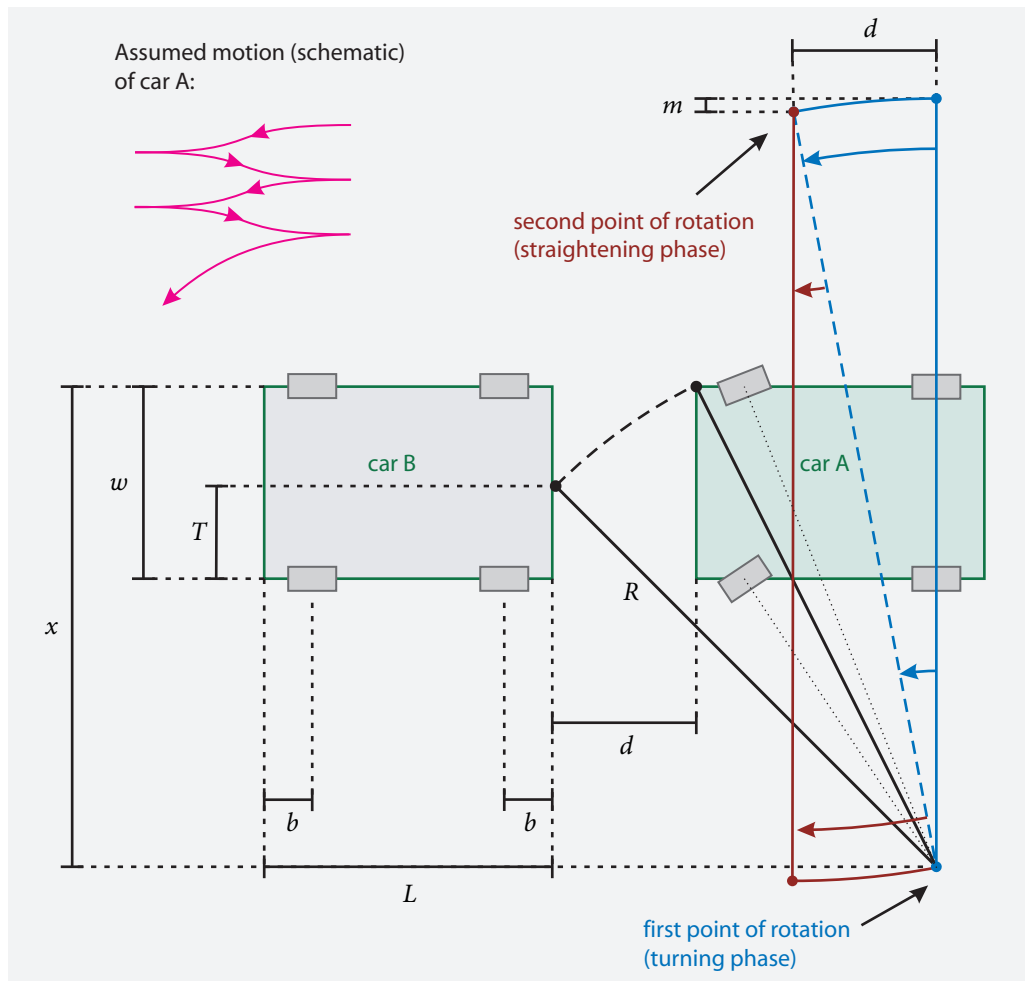


FIGURE 233 Solving the car parking puzzle (© Daniel Hawkins).

would just follow the same arc backward to the initial position, while turning the wheel the other direction would rotate the car even more, as in the first method described above.

Our goal is to turn as far as we can and still be able to completely straighten out by time car A touches car B. To analyse just how much this turn should be, we must first look at the properties of a turning car.

Ackermann steering is the principle that in order for a car to turn smoothly, all four wheels must rotate about the same point. This was patented by Rudolph Ackermann in 1817. Some properties of Ackermann steering in relation to this problem are as follows:

- The back wheels stay in alignment, but the front wheels (which we control), must turn different amounts to rotate about the same centre.
- The centres of rotation for left and right turns are on opposite sides of the car
- For equal magnitudes of left and right turns, the centres of rotation are equidistant from the nearest edge of the car. Figure 233 makes this much clearer.
- All possible centres of rotation are on the same line, which also always passes through the

back wheels.

- When the back wheels are “straight” (straight will always mean in the same orientation as the initial position), they will be vertically aligned with the centres of rotation.
- When the car is turning about one centre, say the one associated with the maximum left turn, then the potential centre associated with the maximum right turn will rotate along with the car. Similarly, when the cars turns about the right centre, the left centre rotates.

Now that we know the properties of Ackermann steering, we can say that in order to maximize the shift downward while preserving the orientation, we must turn left about the 1st centre such that the 2nd centre rotates a *horizontal* distance  $d$ , as shown in [Figure 233](#). When this is achieved, we brake, and turn the steering wheel the complete opposite direction so that we are now turning right about the 2nd centre. Because we shifted leftward  $d$ , we will straighten out at the exact moment car A comes in contact with car B. This results in our goal, a downward shift  $m$  and leftward shift  $d$  while preserving the orientation of car A. A similar process can be performed in reverse to achieve another downward shift  $m$  and a *rightward* shift  $d$ , effectively moving car A from its initial position (before any movement) downward  $2m$  while preserving its orientation. This can be done indefinitely, which is why it is possible to get out of a parking space with an infinitesimal  $d$  between car A and car B. To determine how many times this procedure (both sets of turning and straightening) must be performed, we must only divide  $T$  (remember  $T$  is the amount by which car A must be shifted downward in order to turn out of the parking spot normally) by  $2m$ , the total downward shift for one iteration of the procedure. Symbolically,

$$n = \frac{T}{2m}. \quad (123)$$

In order to get an expression for  $n$  in terms of the geometry of the car, we must solve for  $T$  and  $2m$ . To simplify the derivations we define a new length  $x$ , also shown in [Figure 233](#).

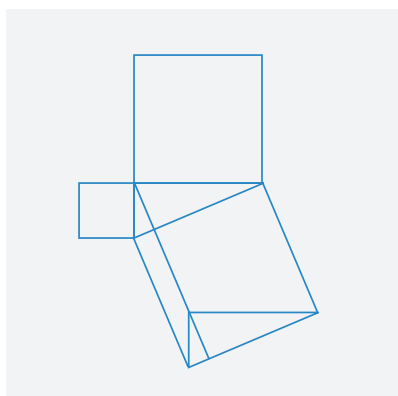
$$x = \sqrt{R^2 - (L - b)^2}$$

$$\begin{aligned} T &= \sqrt{R^2 - (L - b + d)^2} - x + w \\ &= \sqrt{R^2 - (L - b + d)^2} - \sqrt{R^2 - (L - b)^2} + w \end{aligned}$$

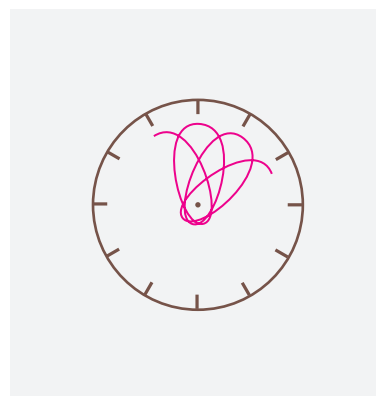
$$\begin{aligned} m &= 2x - w - \sqrt{(2x - w)^2 - d^2} \\ &= 2\sqrt{R^2 - (L - b)^2} - w - \sqrt{(2\sqrt{R^2 - (L - b)^2} - w)^2 - d^2} \\ &= 2\sqrt{R^2 - (L - b)^2} - w - \sqrt{4(R^2 - (L - b)^2) - 4w\sqrt{R^2 - (L - b)^2} + w^2 - d^2} \\ &= 2\sqrt{R^2 - (L - b)^2} - w - \sqrt{4R^2 - 4(L - b)^2 - 4w\sqrt{R^2 - (L - b)^2} + w^2 - d^2} \end{aligned}$$

We then get

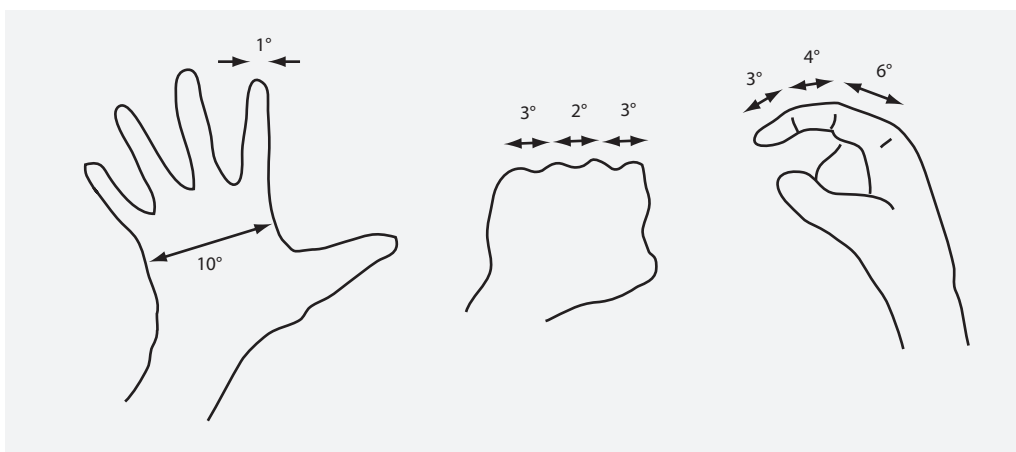
$$n = \frac{T}{2m} = \frac{\sqrt{R^2 - (L - b + d)^2} - \sqrt{R^2 - (L - b)^2} + w}{4\sqrt{R^2 - (L - b)^2} - 2w - 2\sqrt{4R^2 - 4(L - b)^2 - 4w\sqrt{R^2 - (L - b)^2} + w^2 - d^2}}.$$



**FIGURE 234** A simple drawing – one of the many possible one – that allows proving Pythagoras' theorem.



**FIGURE 235** The trajectory of the middle point between the two ends of the hands of a clock.



**FIGURE 236** The angles defined by the hands against the sky, when the arms are extended.

The value of  $n$  must always be rounded *up* to the next integer to determine how many times one must go backward and forward to leave the parking spot.

**Challenge 86**, page 60: Nothing, neither a proof nor a disproof.

**Challenge 87**, page 61: See page 18. On shutters, see also the discussion on page 109.

**Challenge 88**, page 61: A hint for the solution is given in Figure 234.

**Challenge 89**, page 61: Because they are or were liquid.

**Challenge 90**, page 61: The shape is shown in Figure 235; it has eleven lobes.

**Challenge 91**, page 62: The cone angle  $\varphi$ , the angle between the cone axis and the cone border (or equivalently, *half* the apex angle of the cone) is related to the solid angle  $\Omega$  through the relation  $\Omega = 2\pi(1 - \cos \varphi)$ . Use the surface area of a spherical cap to confirm this result.

**Challenge 93**, page 62: See Figure 236.

**Challenge 97**, page 63: Hint: draw all objects involved.

**Challenge 98**, page 63: The curve is obviously called a *catenary*, from Latin 'catena' for chain. The formula for a catenary is  $y = a \cosh(x/a)$ . If you approximate the chain by short straight

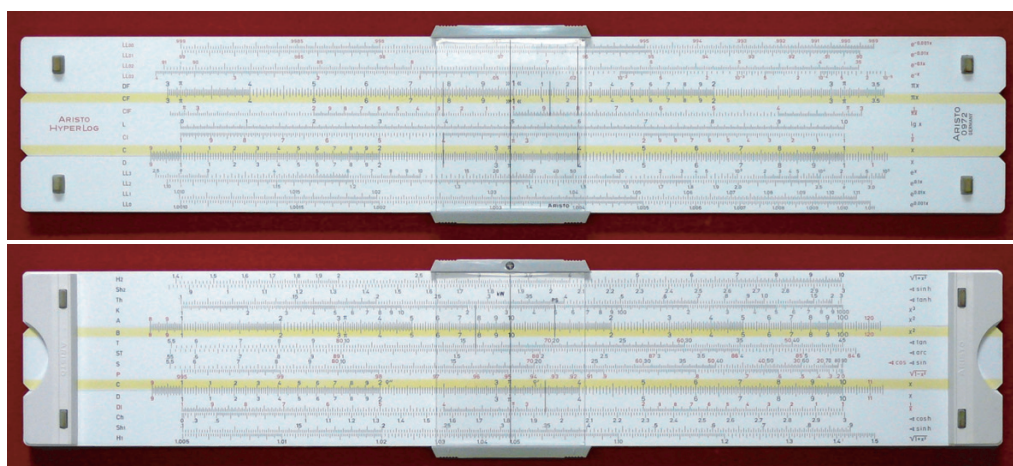


FIGURE 237 A high-end slide rule, around 1970 (© Jörn Lütjens).

segments, you can make wooden blocks that can form an arch without any need for glue. The St. Louis arch is in shape of a catenary. A suspension bridge has the shape of a catenary before it is loaded, i.e., before the track is attached to it. When the bridge is finished, the shape is in between a catenary and a parabola.

**Challenge 99**, page 64: The inverse radii, or curvatures, obey  $a^2 + b^2 + c^2 + d^2 = (1/2)(a+b+c+d)^2$ . This formula was discovered by René Descartes. If one continues putting circles in the remaining spaces, one gets so-called circle packings, a pretty domain of recreational mathematics. They have many strange properties, such as intriguing relations between the coordinates of the circle centres and their curvatures.

**Challenge 100**, page 65: There are two solutions. (Why?) They are the two positive solutions of  $l^2 = (b+x)^2 + (b+b^2/x)^2$ ; the height is then given as  $h = b+x$ . The two solutions are 4.84 m and 1.26 m. There are closed formulas for the solutions; can you find them?

**Challenge 101**, page 65: The best way is to calculate first the height  $B$  at which the blue ladder touches the wall. It is given as a solution of  $B^4 - 2hB^3 - (r^2 - b^2)B^2 + 2h(r^2 - b^2)B - h^2(r^2 - b^2) = 0$ . Integer-valued solutions are discussed in MARTIN GARDNER, *Mathematical Circus*, Spectrum, 1996.

**Challenge 102**, page 65: Draw a logarithmic scale, i.e., put every number at a distance corresponding to its natural logarithm. Such a device, called a *slide rule*, is shown in Figure 237. Slide rules were the precursors of electronic calculators; they were used all over the world in prehistoric times, i.e., until around 1970. See also the web page [www.oughtred.org](http://www.oughtred.org).

**Challenge 103**, page 65: Two more. Build yourself a model of the Sun and the Earth to verify this.

**Challenge 104**, page 65: One option: use the three-dimensional analogue of Pythagoras's theorem. The answer is 9.

**Challenge 105**, page 65: The Sun is exactly behind the back of the observer; it is setting, and the rays are coming from behind and reach deep into the sky in the direction opposite to that of the Sun.

**Challenge 107**, page 66: The volume is given by  $V = \int Adx = \int_{-1}^1 4(1-x^2)dx = 16/3$ .

**Challenge 108**, page 66: Yes. Try it with a paper model.

**Challenge 109**, page 66: Problems appear when quantum effects are added. A two-dimensional

universe would have no matter, since matter is made of spin 1/2 particles. But spin 1/2 particles do not exist in two dimensions. Can you find other reasons?

**Challenge 110**, page 66: Two dimensions do not allow ordering of events. To say ‘before’ and ‘afterwards’ becomes impossible. In everyday life and all domains accessible to measurement, time is surely one-dimensional.

**Challenge 111**, page 66: No experiment has ever found any hint. Can this be nevertheless? Probably not, as argued in the last volume of Motion Mountain.

**Challenge 112**, page 66: If you solve this so-called ropelength problem, you will become a famous mathematician. The length is known only with about 6 decimals of precision. No exact formula is known, and the exact shape of such ideal knots is unknown for all non-trivial knots. The problem is also unsolved for all non-trivial ideal *closed* knots, for which the two ends are glued together.

**Challenge 113**, page 69: From  $x = gt^2/2$  you get the following rule: square the number of seconds, multiply by five and you get the depth in metres.

**Challenge 114**, page 69: Just experiment.

**Challenge 115**, page 69: The Academicians suspended one cannon ball with a thin wire just in front of the mouth of the cannon. When the shot was released, the second, flying cannon ball flew through the wire, thus ensuring that both balls started at the same time. An observer from far away then tried to determine whether both balls touched the Earth at the same time. The experiment is not easy, as small errors in the angle and air resistance confuse the results.

**Challenge 116**, page 70: A parabola has a so-called focus or focal point. All light emitted from that point and reflected exits in the same direction: all light rays are emitted in parallel. The name ‘focus’ – Latin for fireplace – expresses that it is the hottest spot when a parabolic mirror is illuminated. Where is the focus of the parabola  $y = x^2$ ? (Ellipses have two foci, with a slightly different definition. Can you find it?)

**Challenge 117**, page 71: The long jump record could surely be increased by getting rid of the sand stripe and by measuring the true jumping distance with a photographic camera; that would allow jumpers to run more closely to their top speed. The record could also be increased by a small inclined step or by a spring-suspended board at the take-off location, to increase the take-off angle.

**Challenge 118**, page 71: Walk or run in the rain, measure your own speed  $v$  and the angle from the vertical  $\alpha$  with which the rain appears to fall. Then the speed of the rain is  $v_{\text{rain}} = v/\tan \alpha$ .

**Challenge 120**, page 72: Neglecting air resistance and approximating the angle by  $45^\circ$ , we get  $v = \sqrt{dg}$ , or about 3.8 m/s. This speed is created by a steady pressure build-up, using blood pressure, which is suddenly released with a mechanical system at the end of the digestive canal. The cited reference tells more about the details.

**Challenge 121**, page 72: On horizontal ground, for a speed  $v$  and an angle from the horizontal  $\alpha$ , neglecting air resistance and the height of the thrower, the distance  $d$  is  $d = v^2 \sin 2\alpha/g$ .

**Challenge 122**, page 72: Check your calculation with the information that the 1998 world record is juggling with 9 balls.

**Challenge 123**, page 72: It is said so, as rain drops would then be ice spheres and fall with high speed.

**Challenge 124**, page 72: There are conflicting statements in the literature. But it is a fact that people have gone to hospital and even died because a falling bullet went straight through their head. (See S. MIRSKY, It is high, it is far, *Scientific American* p. 86, February 2004, or C. TUIJN, Vallende kogels, *Nederlands tijdschrift voor natuurkunde* 71, pp. 224–225, 2005.) In addition, the lead in bullets is bad for the environment.



**Challenge 125**, page 72: This is a true story. The answer can only be given if it is known whether the person had the chance to jump while running or not. In the case described by R. CROSS, Forensic physics 101: falls from a height, *American Journal of Physics* 76, pp. 833–837, 2008, there was no way to run, so that the answer was: murder.

**Challenge 126**, page 73: For jumps of an animal of mass  $m$  the necessary energy  $E$  is given as  $E = mgh$ , and the work available to a muscle is roughly speaking proportional to its mass  $W \sim m$ . Thus one gets that the height  $h$  is independent of the mass of the animal. In other words, the specific mechanical energy of animals is around  $1.5 \pm 0.7$  J/kg.

**Challenge 127**, page 73: Stones never follow parabolas: when studied in detail, i.e., when the change of  $g$  with height is taken into account, their precise path turns out to be an ellipse. This shape appears most clearly for long throws, such as throws around a sizeable part of the Earth, or for orbiting objects. In short, stones follow parabolas only if the Earth is assumed to be flat. If its curvature is taken into account, they follow ellipses.

**Challenge 128**, page 73: The set of all rotations around a point in a plane is indeed a vector space. What about the set of all rotations around *all* points in a plane? And what about the three-dimensional cases?

**Challenge 131**, page 74: The scalar product between two vectors  $\mathbf{a}$  and  $\mathbf{b}$  is given by

$$\mathbf{a} \cdot \mathbf{b} = ab \cos \angle(\mathbf{a}, \mathbf{b}) . \quad (124)$$

How does this differ from the vector product?

**Challenge 134**, page 77: A candidate for low acceleration of a physical system might be the accelerations measured by gravitational wave detectors. They are below  $10^{-13}$  m/s<sup>2</sup>.

**Challenge 135**, page 76: In free fall (when no air is present) or inside a space station orbiting the Earth, one is accelerated but does not feel anything. In fact, this indistinguishability or equivalence between acceleration and ‘feeling nothing’ was an essential step for Albert Einstein in his development of general relativity.

**Challenge 136**, page 77: Professor to student: What is the derivative of velocity? Acceleration! What is the derivative of acceleration? I don’t know. *Jerk!* The fourth, fifth and sixth derivatives of position are sometimes called *snap*, *crackle* and *pop*.

**Challenge 138**, page 80: One can argue that any source of light must have finite size.

**Challenge 140**, page 80: What the unaided human eye perceives as a tiny black point is usually about 50  $\mu\text{m}$  in diameter.

**Challenge 141**, page 80: See page 132.

**Challenge 142**, page 80: One has to check carefully whether the conceptual steps that lead us to extract the concept of point from observations are correct. It will be shown in the final part of the adventure that this is not the case.

**Challenge 143**, page 81: One can rotate the hand in a way that the arm makes the motion described. See also page 110.

**Challenge 144**, page 81: Any number, without limit.

**Challenge 145**, page 81: The blood and nerve supply is not possible if the wheel has an axle. The method shown to avoid tangling up connections only works when the rotating part has *no* axle: the ‘wheel’ must float or be kept in place by other means. It thus becomes impossible to make a wheel *axle* using a single piece of skin. And if a wheel without an axle could be built (which might be possible), then the wheel would periodically run over the connection. Could such a axle-free connection realize a propeller?

By the way, it is still thinkable that animals have wheels on axles, if the wheel is a 'dead' object. Even if blood supply technologies like continuous flow reactors were used, animals could not make such a detached wheel grow in a way tuned to the rest of the body and they would have difficulties repairing a damaged wheel. Detached wheels cannot be grown on animals; they must be dead.

**Challenge 146**, page 82: The brain in the skull, the blood factories inside bones or the growth of the eye are examples.

**Challenge 147**, page 83: In 2007, the largest big wheels for passengers are around 150 m in diameter. The largest wind turbines are around 125 m in diameter. Cement kilns are the longest wheels: they can be over 300 m along their axis.

**Challenge 148**, page 83: Air resistance reduces the maximum distance, which is achieved for an angle of about  $\pi/4 = 45^\circ$ , from around  $v^2/g = 91.7$  m down to around 50 m.

**Challenge 152**, page 86: One can also add the Sun, the sky and the landscape to the list.

**Challenge 153**, page 87: There is no third option. Ghosts, hallucinations, Elvis sightings, or extraterrestrials must all be objects or images. Even shadows are only special types of images.

**Challenge 154**, page 87: The issue was hotly discussed in the seventeenth century; even Galileo argued for them being images. However, they are objects, as they can collide with other objects, as the spectacular collision between Jupiter and the comet Shoemaker-Levy 9 in 1994 showed. In the meantime, satellites have been made to collide with comets and even to shoot at them (and hitting).

**Challenge 155**, page 88: The minimum speed is roughly the one at which it is possible to ride without hands. If you do so, and then *gently* push on the steering wheel, you can make the experience described above. Watch out: too strong a push will make you fall badly.

The *bicycle* is one of the most complex mechanical systems of everyday life, and it is still a subject of research. And obviously, the world experts are Dutch. An overview of the behaviour of a bicycle is given in [Figure 238](#). The main result is that the bicycle is stable in the upright position at a range of medium speeds. Only at low and at large speeds must the rider actively steer to ensure upright position of the bicycle.

For more details, see J. P. MEIJAARD, J. M. PAPADOPOULOS, A. RUINA & A. L. SCHWAB, Linearized dynamics equations for the balance and steer of a bicycle: a benchmark and review, *Proceedings of the Royal Society A* 463, pp. 1955–1982, 2007, and J. D. G. KOIJMAN, A. L. SCHWAB & J. P. MEIJAARD, Experimental validation of a model of an uncontrolled bicycle, *Multibody System Dynamics* 19, pp. 115–132, 2008. See also the [audiophile.tam.cornell.edu/~als93/Bicycle/index.htm](http://audiophile.tam.cornell.edu/~als93/Bicycle/index.htm) website.

**Challenge 156**, page 90: If the moving ball is not rotating, after the collision the two balls will depart with a *right* angle between them.

**Challenge 157**, page 91: Part of the energy is converted into heat; the rest is transferred as kinetic energy of the concrete block. As the block is heavy, its speed is small and easily stopped by the human body. This effect works also with anvils, it seems. In another common variation the person does not lie on nails, but on air: he just keeps himself horizontal, with head and shoulders on one chair, and the feet on a second one.

**Challenge 158**, page 92: Yes, the definition of mass works also for magnetism, because the precise condition is not that the interaction is central, but that the interaction realizes a more general condition that includes accelerations such as those produced by magnetism. Can you deduce the condition from the definition of mass as that quantity that keeps momentum conserved?

**Challenge 159**, page 92: The weight decreased due to the evaporated water lost by sweating and, to a minor degree, due to the exhaled carbon bound in carbon dioxide.

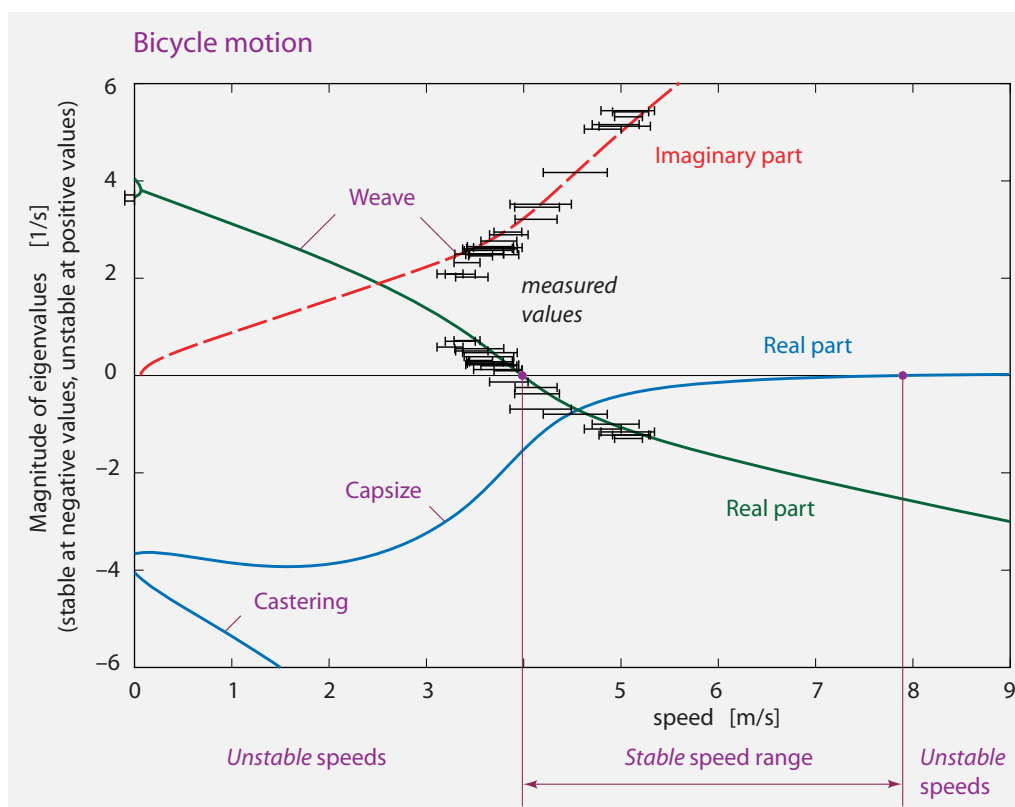


FIGURE 238 The measured (black bars) and calculated behaviour (coloured lines) – more precisely, the dynamical eigenvalues – of a bicycle as a function of its speed (© Arend Schwab).

Page 148

**Challenge 160**, page 92: Rather than using the inertial effects of the Earth, it is easier to deduce its mass from its gravitational effects.

**Challenge 164**, page 94: At first sight, relativity implies that tachyons have imaginary mass; however, the imaginary factor can be extracted from the mass–energy and mass–momentum relation, so that one can define a real mass value for tachyons; as a result, faster tachyons have smaller energy and smaller momentum. Both momentum and energy can be a negative number of any size.

**Challenge 165**, page 95: The leftmost situation has a tiny effect, the second makes the car roll forward and backward, the right two pictures show ways to open wine bottles without bottle opener.

**Challenge 166**, page 95: Legs are never perfectly vertical; they would immediately glide away. Once the cat or the person is on the floor, it is almost impossible to stand up again.

**Challenge 167**, page 95: Momentum (or centre of mass) conservation would imply that the environment would be accelerated into the opposite direction. Energy conservation would imply that a huge amount of energy would be transferred between the two locations, melting everything in between. Teleportation would thus contradict energy and momentum conservation.

**Challenge 168**, page 96: The part of the tides due to the Sun, the solar wind, and the interactions between both magnetic fields are examples of friction mechanisms between the Earth and the Sun.

**Challenge 169**, page 97: With the factor  $1/2$ , increase of (physical) kinetic energy is equal to the (physical) work performed on a system: total energy is thus conserved only if the factor  $1/2$  is added.

**Challenge 171**, page 98: It is a smart application of momentum conservation.

**Challenge 172**, page 98: Neither. With brakes on, the damage is higher, but still equal for both cars.

**Challenge 173**, page 99: Heating systems, transport engines, engines in factories, steel plants, electricity generators covering the losses in the power grid, etc. By the way, the richest countries in the world, such as Sweden or Switzerland, consume only half the energy per inhabitant as the USA. This waste is one of the reasons for the lower average standard of living in the USA.

**Challenge 178**, page 102: Just throw it into the air and compare the dexterity needed to make it turn around various axes.

**Challenge 179**, page 103: Use the definition of the moment of inertia and Pythagoras' theorem for every mass element of the body.

**Challenge 180**, page 103: Hang up the body, attaching the rope in two different points. The crossing point of the prolonged rope lines is the centre of mass.

**Challenge 182**, page 104: Spheres have an orientation, because we can always add a tiny spot on their surface. This possibility is not given for microscopic objects, and we shall study this situation in the part on quantum theory.

**Challenge 181**, page 103: See Tables 19 and 20.

**Challenge 183**, page 105: Self-propelled linear motion contradicts the conservation of momentum; self-propelled change of orientation (as long as the motion stops again) does not contradict any conservation law. But the deep, final reason for the difference will be unveiled in the final part of our adventure.

**Challenge 184**, page 105: Yes, the ape can reach the banana. The ape just has to turn around its own axis. For every turn, the plate will rotate a bit towards the banana. Of course, other methods, like blowing at a right angle to the axis, peeing, etc., are also possible.

**Challenge 186**, page 105: The points that move exactly along the radial direction of the wheel form a circle below the axis and above the rim. They are the points that are sharp in Figure 68 of page 105.

**Challenge 187**, page 106: Use the conservation of angular momentum around the point of contact. If all the wheel's mass is assumed in the rim, the final rotation speed is half the initial one; it is independent of the friction coefficient.

**Challenge 189**, page 107: Probably the 'rest of the universe' was meant by the writer. Indeed, a moving part never shifts the centre of gravity of a closed system. But is the universe closed? Or a system? The last part of our adventure covers these issues.

**Challenge 190**, page 107: The human body is more energy-efficient at low and medium power output. The topic is still subject of research, as detailed in the cited reference. The critical slope is estimated to be around  $16^\circ$  for uphill walkers, but should differ for downhill walkers.

**Challenge 191**, page 107: Hint: an energy per distance is a force.

**Challenge 192**, page 107: The conservation of angular momentum saves the glass. Try it.

**Challenge 193**, page 108: First of all, MacDougall's experimental data is flawed. In the six cases MacDougall examined, he did not know the exact timing of death. His claim of a mass decrease cannot be deduced from his own data. Modern measurements on dying sheep, about the same mass as humans, have shown no mass change, but clear weight pulses of a few dozen grams when the heart stopped. This temporary weight decrease could be due to the expelling of air or

moisture, to the relaxing of muscles, or to the halting of blood circulation. The question is not settled.

**Challenge 195**, page 108: Assuming a square mountain, the height  $h$  above the surrounding crust and the depth  $d$  below are related by

$$\frac{h}{d} = \frac{\rho_m - \rho_c}{\rho_c} \quad (125)$$

where  $\rho_c$  is the density of the crust and  $\rho_m$  is the density of the mantle. For the density values given, the ratio is 6.7, leading to an additional depth of 6.7 km below the mountain.

**Challenge 198**, page 109: The behaviour of the spheres can only be explained by noting that elastic waves propagate through the chain of balls. Only the propagation of these elastic waves, in particular their reflection at the end of the chain, explains that the same number of balls that hit on one side are lifted up on the other. For long times, friction makes all spheres oscillate in phase. Can you confirm this?

**Challenge 199**, page 109: When the short cylinder hits the long one, two compression waves start to run from the point of contact through the two cylinders. When each compression wave arrives at the end, it is reflected as an expansion wave. If the geometry is well chosen, the expansion wave coming back from the short cylinder can continue into the long one (which is still in his compression phase). For sufficiently long contact times, waves from the short cylinder can thus deposit much of their energy into the long cylinder. Momentum is conserved, as is energy; the long cylinder is oscillating in length when it detaches, so that not all its energy is translational energy. This oscillation is then used to drive nails or drills into stone walls. In commercial hammer drills, length ratios of 1:10 are typically used.

**Challenge 200**, page 110: The momentum transfer to the wall is double when the ball rebounds perfectly.

**Challenge 201**, page 110: If the cork is in its intended position: take the plastic cover off the cork, put the cloth around the bottle (this is for protection reasons only) and repeatedly hit the bottle on the floor or a fall in an inclined way, as shown in Figure 62 on page 95. With each hit, the cork will come out a bit.

If the cork has fallen inside the bottle: put half the cloth inside the bottle; shake until the cork falls onto the cloth. Pull the cloth out: first slowly, until the cloth almost surrounds the cork, and then strongly.

**Challenge 203**, page 110: The atomic force microscope.

**Challenge 205**, page 111: Running man:  $E \approx 0.5 \cdot 80 \text{ kg} \cdot (5 \text{ m/s})^2 = 1 \text{ kJ}$ ; rifle bullet:  $E \approx 0.5 \cdot 0.04 \text{ kg} \cdot (500 \text{ m/s})^2 = 5 \text{ kJ}$ .

**Challenge 206**, page 111: It almost doubles in size.

**Challenge 207**, page 111: At the highest point, the acceleration is  $g \sin \alpha$ , where  $\alpha$  is the angle of the pendulum at the highest point. At the lowest point, the acceleration is  $v^2/l$ , where  $l$  is the length of the pendulum. Conservation of energy implies that  $v^2 = 2gl(1 - \cos \alpha)$ . Thus the problem requires that  $\sin \alpha = 2(1 - \cos \alpha)$ . This results in  $\cos \alpha = 3/5$ .

**Challenge 208**, page 111: One needs the mass change equation  $dm/dt = \pi \rho_{\text{vapour}} r^2 |v|$  due to the vapour and the drop speed evolution  $m dv/dt = mg - v dm/dt$ . These two equations yield

$$\frac{dv^2}{dr} = \frac{2g}{C} - 6 \frac{v^2}{r} \quad (126)$$

where  $C = \rho_{\text{vapour}}/4\rho_{\text{water}}$ . The trick is to show that this can be rewritten as

$$r \frac{d}{dr} \frac{v^2}{r} = \frac{2g}{C} - 7 \frac{v^2}{r}. \quad (127)$$

For large times, all physically sensible solutions approach  $v^2/r = 2g/7C$ ; this implies that for large times,

$$\frac{dv}{dt} \frac{v^2}{r} = \frac{g}{7} \quad \text{and} \quad r = \frac{gC}{14} t^2. \quad (128)$$

About this famous problem, see for example, B. F. EDWARDS, J. W. WILDER & E. E. SCIME, Dynamics of falling raindrops, *European Journal of Physics* 22, pp. 113–118, 2001, or A. D. SOKAL, The falling raindrop, revisited, preprint at [arxiv.org/abs/09080090](https://arxiv.org/abs/09080090).

**Challenge 211**, page 111: Weigh the bullet and shoot it against a mass hanging from the ceiling. From the mass and the angle it is deflected to, the momentum of the bullet can be determined.

**Challenge 213**, page 112: The curve described by the midpoint of a ladder sliding down a wall is a circle.

**Challenge 214**, page 112: The switched use the power that is received when the switch is pushed and feed it to a small transmitter that acts a high frequency remote control to switch on the light.

**Challenge 215**, page 112: A clever arrangement of bimetals is used. They move every time the temperature changes from day to night – and vice versa – and wind up a clock spring. The clock itself is a mechanical clock with low energy consumption.

**Challenge 218**, page 116: The Coriolis effect can be seen as the sum two different effects of equal magnitude. The first effect is the following: on a rotating background, velocity changes over time. What an inertial (nonrotating) observer sees as a *constant* velocity will be seen a velocity that *changes* over time by the rotating observer. The acceleration seen by the rotating observer is negative, and is proportional to the angular velocity and to the velocity.

The second effect is change of velocity in space. In a rotating frame of reference, different points have different velocities. The effect is negative, and proportional to the angular velocity and to the velocity.

In total, the Coriolis acceleration (or Coriolis effect) is thus  $\mathbf{a}_C = -2\boldsymbol{\omega} \times \mathbf{v}$ .

**Challenge 219**, page 117: A *short* pendulum of length  $L$  that swings in two dimensions (with amplitude  $\rho$  and orientation  $\varphi$ ) shows two additional terms in the Lagrangian  $\mathcal{L}$ :

$$\mathcal{L} = T - V = \frac{1}{2} m \dot{\rho}^2 \left( 1 + \frac{\rho^2}{L^2} \right) + \frac{l_z^2}{2m\rho^2} - \frac{1}{2} m \omega_0^2 \rho^2 \left( 1 + \frac{\rho^2}{4L^2} \right) \quad (129)$$

where as usual the basic frequency is  $\omega_0^2 = g/L$  and the angular momentum is  $l_z = m\rho^2 \dot{\varphi}$ . The two additional terms disappear when  $L \rightarrow \infty$ ; in that case, if the system oscillates in an ellipse with semiaxes  $a$  and  $b$ , the ellipse is fixed in space, and the frequency is  $\omega_0$ . For *finite* pendulum length  $L$ , the frequency changes to

$$\omega = \omega_0 \left( 1 - \frac{a^2 + b^2}{16L^2} \right). \quad (130)$$

The ellipse turns with a frequency

$$\Omega = \omega \frac{3ab}{8L^2}. \quad (131)$$

These formulae can be derived using the least action principle, as shown by C. G. GRAY, G. KARL & V. A. NOVIKOV, Progress in classical and quantum variational principles, [arxiv.org/abs/physics/0312071](https://arxiv.org/abs/physics/0312071). In other words, a short pendulum in elliptical motion shows a precession even *without* the Coriolis effect. Since this precession frequency diminishes with  $1/L^2$ , the effect is small for long pendulums, where only the Coriolis effect is left over. To see the Coriolis effect in a short pendulum, one thus has to avoid that it starts swinging in an elliptical orbit by adding a mechanism that suppresses elliptical motion.

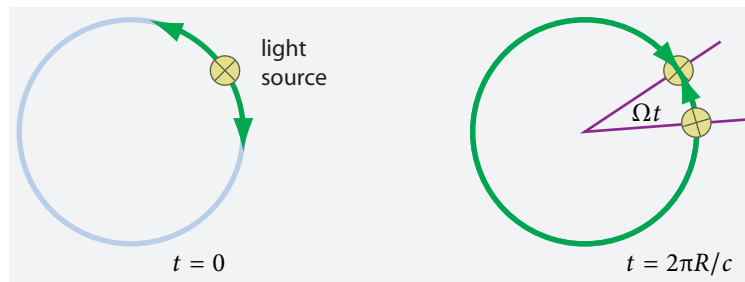


FIGURE 239 Deducing the expression for the Sagnac effect.

**Challenge 220**, page 118: The Coriolis acceleration is the reason for the deviation from the straight line. The Coriolis acceleration is due to the change of speed with distance from the rotation axis. Now think about a pendulum, located in Paris, swinging in the North-South direction with amplitude  $A$ . At the Southern end of the swing, the pendulum is further from the axis by  $A \sin \varphi$ , where  $\varphi$  is the latitude. At that end of the swing, the central support point overtakes the pendulum bob with a relative horizontal speed given by  $v = 2\pi A \sin \varphi / 23 \text{ h}56 \text{ min}$ . The period of precession is given by  $T_F = v / 2\pi A$ , where  $2\pi A$  is the circumference  $2\pi A$  of the envelope of the pendulum's path (relative to the Earth). This yields  $T_F = 23 \text{ h}56 \text{ min} / \sin \varphi$ . Why is the value that appears in the formula not 24 h, but 23 h56 min?

**Challenge 221**, page 118: The axis stays fixed with respect to distant stars, not with respect to absolute space (which is an entity that cannot be observed at all).

**Challenge 222**, page 118: Rotation leads to a small frequency and thus colour changes of the circulating light.

**Challenge 223**, page 118: The weight changes when going east or when moving west due to the Coriolis acceleration. If the rotation speed is tuned to the oscillation frequency of the balance, the effect is increased by resonance. This trick was also used by Eötvös.

**Challenge 224**, page 118: The Coriolis acceleration makes the bar turn, as every moving body is deflected to the side, and the two deflections add up in this case. The direction of the deflection depends on whether the experiment is performed on the northern or the southern hemisphere.

**Challenge 225**, page 118: When rotated by  $\pi$  around an east-west axis, the Coriolis force produces a drift velocity of the liquid around the tube. It has the value

$$v = 2\omega r \sin \theta, \quad (132)$$

as long as friction is negligible. Here  $\omega$  is the angular velocity of the Earth,  $\theta$  the latitude and  $r$  the (larger) radius of the torus. For a tube with 1 m diameter in continental Europe, this gives a speed of about  $6.3 \cdot 10^{-5} \text{ m/s}$ .

The measurement can be made easier if the tube is restricted in diameter at one spot, so that the velocity is increased there. A restriction by an area factor of 100 increases the speed by the same factor. When the experiment is performed, one has to carefully avoid any other effects that lead to moving water, such as temperature gradients across the system.

**Challenge 226**, page 120: Imagine a circular light path (for example, inside a circular glass fibre) and two beams moving in opposite directions along it, as shown in Figure 239. If the fibre path rotates with rotation frequency  $\Omega$ , we can deduce that, after one turn, the difference  $\Delta L$  in path length is

$$\Delta L = 2R\Omega t = \frac{4\pi R^2 \Omega}{c}. \quad (133)$$



The phase difference is thus

$$\Delta\varphi = \frac{8\pi^2 R^2}{c\lambda} \Omega \quad (134)$$

if the refractive index is 1. This is the required formula for the main case of the Sagnac effect.

It is regularly suggested that the Sagnac effect can only be understood with help of general relativity; this is wrong. As just done, the effect is easily deduced from the invariance of the speed of light  $c$ . The effect is a consequence of special relativity.

**Challenge 227**, page 121: The metal rod is slightly longer on one side of the axis. When the wire keeping it up is burned with a candle, its moment of inertia decreases by a factor of  $10^4$ ; thus it starts to rotate with (ideally)  $10^4$  times the rotation rate of the Earth, a rate which is easily visible by shining a light beam on the mirror and observing how its reflection moves on the wall.

**Challenge 228**, page 125: The original result by Bessel was  $0.3136''$ , or 657.7 thousand orbital radii, which he thought to be 10.3 light years or 97.5 Pm.

**Challenge 230**, page 129: The galaxy forms a stripe in the sky. The galaxy is thus a flattened structure. This is even clearer in the infrared, as shown more clearly in [Figure 81](#) on [page 193](#). From the flattening (and its circular symmetry) we can deduce that the galaxy must be rotating. Thus other matter must exist in the universe.

**Challenge 232**, page 132: If the Earth changed its rotation speed ever so slightly we would walk inclined, the water of the oceans would flow north, the atmosphere would be filled with storms and earthquakes would appear due to the change in Earth's shape.

**Challenge 234**, page 132: The scale reacts to your heartbeat. The weight is almost constant over time, except when the heart beats: for a short duration of time, the weight is somewhat lowered at each beat. Apparently it is due to the blood hitting the aortic arch when the heart pumps it upwards. The speed of the blood is about 0.3 m/s at the maximum contraction of the left ventricle. The distance to the aortic arch is a few centimetres. The time between the contraction and the reversal of direction is about 15 ms.

**Challenge 235**, page 132: Use [Figure 81](#) on [page 116](#) for the second half of the trajectory, and think carefully about the first half.

**Challenge 236**, page 132: Hint: starting rockets at the Equator saves a lot of energy, thus of fuel and of weight.

**Challenge 237**, page 133: The flame leans towards the inside.

**Challenge 238**, page 133: The ball leans in the direction it is accelerated to. As a result, one could imagine that the ball in a glass at rest pulls upwards because the floor is accelerated upwards. We will come back to this issue in the section of general relativity.

**Challenge 240**, page 133: For your exam it is better to say that centrifugal force does not exist. But since in each stationary system there is a force balance, the discussion is somewhat a red herring.

**Challenge 242**, page 133: Place the tea in cups on a board and attach the board to four long ropes that you keep in your hand.

**Challenge 243**, page 134: The friction of the tides on Earth are the main cause.

**Challenge 244**, page 134: An earthquake with Richter magnitude of 12 is 1000 times the energy of the 1960 Chile quake with magnitude 10; the latter was due to a crack throughout the full 40 km of the Earth's crust along a length of 1000 km in which both sides slipped by 10 m with respect to each other. Only the impact of a meteorite could lead to larger values than 12.

**Challenge 245**, page 134: This is not easy; a combination of friction and torques play a role. See for example the article J. SAUER, E. SCHÖRNER & C. LENNERZ, Real-time rigid body simula-

tion of some classical mechanical toys, 10th European Simulation and Symposium and Exhibition (ESS '98) 1998, pp. 93–98, or [http://www.lennerz.de/paper\\_ess98.pdf](http://www.lennerz.de/paper_ess98.pdf).

**Challenge 247**, page 135: If a wedding ring rotates on an axis that is not a principal one, angular momentum and velocity are not parallel.

**Challenge 248**, page 135: Yes; it happens twice a year. To minimize the damage, dishes should be dark in colour.

**Challenge 249**, page 135: A rocket fired from the back would be a perfect defence against planes attacking from behind. However, when released, the rocket is effectively flying backwards with respect to the air, thus turns around and then becomes a danger to the plane that launched it. Engineers who did not think about this effect almost killed a pilot during the first such tests.

**Challenge 250**, page 135: Whatever the ape does, whether it climbs up or down or even lets himself fall, it remains at the same height as the mass. Now, what happens if there is friction at the wheel?

**Challenge 251**, page 135: Yes, if he moves at a large enough angle to the direction of the boat's motion.

**Challenge 253**, page 135: The moment of inertia is  $\Theta = \frac{2}{5}mr^2$ .

**Challenge 254**, page 136: The moments of inertia are equal also for the cube, but the values are  $\Theta = \frac{1}{6}ml^2$ . The efforts required to put a sphere and a cube into rotation are thus different.

**Challenge 255**, page 136: See the article by C. UCKE & H. -J. SCHLICHTING, Faszinierendes Dynabee, *Physik in unserer Zeit* 33, pp. 230–231, 2002.

**Challenge 256**, page 136: See the article by C. UCKE & H. -J. SCHLICHTING, Die kreisende Büroklammer, *Physik in unserer Zeit* 36, pp. 33–35, 2005.

**Challenge 257**, page 136: Yes. Can you imagine what happens for an observer on the Equator?

**Challenge 258**, page 137: A straight line at the zenith, and circles getting smaller at both sides. See an example on the website [antwrrp.gsfc.nasa.gov/apod/ap021115.html](http://antwrrp.gsfc.nasa.gov/apod/ap021115.html).

**Challenge 260**, page 137: The plane is described in the websites cited; for a standing human the plane is the vertical plane containing the two eyes.

**Challenge 261**, page 138: As said before, legs are simpler than wheels to grow, to maintain and to repair; in addition, legs do not require flat surfaces (so-called 'streets') to work.

**Challenge 262**, page 139: The staircase formula is an empirical result found by experiment, used by engineers world-wide. Its origin and explanation seems to be lost in history.

**Challenge 263**, page 139: Classical or everyday nature is right-left symmetric and thus requires an even number of legs. Walking on two-dimensional surfaces naturally leads to a minimum of four legs.

**Challenge 265**, page 141: The length of the day changes with latitude. So does the length of a shadow or the elevation of stars at night, facts that are easily checked by telephoning a friend. Ships appear at the horizon first by showing only their masts. These arguments, together with the round shadow of the earth during a lunar eclipse and the observation that everything falls downwards everywhere, were all given already by Aristotle, in his text *On the Heavens*. It is now known that everybody in the last 2500 years knew that the Earth is a sphere. The myth that many people used to believe in a flat Earth was put into the world – as rhetorical polemic – by Copernicus. The story then continued to be exaggerated more and more during the following centuries, because a new device for spreading lies had just been invented: book printing. Fact is that for 2500 years the vast majority of people knew that the Earth is a sphere.

**Challenge 266**, page 141: Robert Peary had forgotten that on the date he claimed to be at the North Pole, 6th of April 1909, the Sun is very low on the horizon, casting very long shadows,

about ten times the height of objects. But on his photograph the shadows are much shorter. (In fact, the picture is taken in such a way to hide all shadows as carefully as possible.) Interestingly, he had even convinced the US congress to officially declare him the first man on the North Pole in 1911. (A rival crook had claimed to have reached it before Peary, but his photograph has the same mistake.) Peary also cheated on the travelled distances of the last few days; he also failed to mention that the last days he was pulled by his partner, Matthew Henson, because he was not able to walk any more. In fact Matthew Henson deserves more credit for that adventure than Peary. Henson, however, did not know that Peary cheated on the position they had reached.

**Challenge 267**, page 141: Yes, the effect has been measured for skyscrapers. Can you estimate the values?

**Challenge 268**, page 143: The tip of the velocity arrow, when drawn over time, produces a circle around the centre of motion.

**Challenge 269**, page 143: Draw a figure of the situation.

**Challenge 270**, page 143: Again, draw a figure of the situation.

**Challenge 271**, page 143: The value of the product  $GM$  for the Earth is  $4.0 \cdot 10^{14} \text{ m}^3/\text{s}^2$ .

**Challenge 272**, page 144: All points can be reached for general inclinations; but when shooting horizontally in one given direction, only points on the first half of the circumference can be reached.

**Challenge 274**, page 145: On the moon, the gravitational acceleration is  $1.6 \text{ m/s}^2$ , about one sixth of the value on Earth. The surface values for the gravitational acceleration for the planets can be found on many internet sites.

**Challenge 275**, page 145: The Atwood machine is the answer: two almost equal masses  $m_1$  and  $m_2$  connected by a string hanging from a well-oiled wheel of negligible mass. The heavier one falls very slowly. Can show that the acceleration  $a$  of this ‘unfree’ fall is given by  $a = g(m_1 - m_2)/(m_1 + m_2)$ ? In other words, the smaller the mass difference is, the slower the fall is.

**Challenge 276**, page 146: You should absolutely try to understand the origin of this expression. It allows understanding many important concepts of mechanics. The idea is that for small amplitudes, the acceleration of a pendulum of length  $l$  is due to gravity. Drawing a force diagram for a pendulum at a general angle  $\alpha$  shows that

$$\begin{aligned} ma &= -mg \sin \alpha \\ ml \frac{d^2\alpha}{dt^2} &= -mg \sin \alpha \\ l \frac{d^2\alpha}{dt^2} &= -g \sin \alpha . \end{aligned} \quad (135)$$

For the mentioned small amplitudes (below  $15^\circ$ ) we can approximate this to

$$l \frac{d^2\alpha}{dt^2} = -g\alpha . \quad (136)$$

This is the equation for a harmonic oscillation (i.e., a sinusoidal oscillation). The resulting motion is:

$$\alpha(t) = A \sin(\omega t + \varphi) . \quad (137)$$

The amplitude  $A$  and the phase  $\varphi$  depend on the initial conditions; however, the oscillation frequency is given by the length of the pendulum and the acceleration of gravity (check it!):

$$\omega = \sqrt{\frac{l}{g}} . \quad (138)$$

(For arbitrary amplitudes, the formula is much more complex; see the internet or special mechanics books for more details.)

**Challenge 277**, page 146: Walking speed is proportional to  $l/T$ , which makes it proportional to  $l^{1/2}$ . The relation is also true for animals in general. Indeed, measurements show that the maximum walking speed (thus not the running speed) across all animals is given by

$$v_{\text{maxwalking}} = (2.2 \pm 0.2) \text{ m}^{1/2}/\text{s} \sqrt{l}. \quad (139)$$

**Challenge 280**, page 147: The acceleration due to gravity is  $a = Gm/r^2 \approx 5 \text{ nm/s}^2$  for a mass of 75 kg. For a fly with mass  $m_{\text{fly}} = 0.1 \text{ g}$  landing on a person with a speed of  $v_{\text{fly}} = 1 \text{ cm/s}$  and deforming the skin (without energy loss) by  $d = 0.3 \text{ mm}$ , a person would be accelerated by  $a = (v^2/d)(m_{\text{fly}}/m) = 0.4 \mu\text{m/s}^2$ . The energy loss of the inelastic collision reduces this value at least by a factor of ten.

**Challenge 284**, page 151: The easiest way to see this is to picture gravity as a flux emanating from a sphere. This gives a  $1/r^{d-1}$  dependence for the force and thus a  $1/r^{d-2}$  dependence of the potential.

**Challenge 286**, page 152: Since the paths of free fall are ellipses, which are curves lying in a plane, this is obvious.

**Challenge 287**, page 154: The vector  $OF$  can be calculated by using  $OS = -(GmM/E)OP/OP$  and then translating the construction given in the figure into formulae. This exercise yields

$$OF = \frac{K}{mE} \quad (140)$$

where

$$K = \mathbf{p} \times \mathbf{L} - GMm\mathbf{x}/x \quad (141)$$

is the so-called Runge–Lenz vector. (We have used  $\mathbf{x} = \mathbf{OP}$  for the position of the orbiting body,  $\mathbf{p}$  for its momentum and  $\mathbf{L}$  for its angular momentum. The Runge–Lenz vector  $\mathbf{K}$  is constant along the orbit of a body, thus has the same value for any position  $\mathbf{x}$  on the orbit. (Prove it by starting from  $\mathbf{x}\mathbf{K} = xK \cos \theta$ .) The Runge–Lenz vector is thus a conserved quantity in universal gravity. As a result, the vector  $OF$  is also constant in time. The Runge–Lenz vector is also often used in quantum mechanics, when calculating the energy levels of a hydrogen atom, as it appears in all problems with a  $1/r$  potential. (In fact, the incorrect name ‘Runge–Lenz vector’ is due to Wolfgang Pauli; the discoverer of the vector was, in 1710, Jakob Hermann.)

**Challenge 288**, page 154: See page 157.

**Challenge 290**, page 155: The low gravitational acceleration of the Moon,  $1.6 \text{ m/s}^2$ , implies that gas molecules at usual temperatures can escape its attraction.

**Challenge 292**, page 156: A flash of light is sent to the Moon, where several Cat’s-eyes have been deposited by the Lunokhod and Apollo missions. The measurement precision of the time a flash take to go and come back is sufficient to measure the Moon’s distance change. For more details, see challenge 8.

**Challenge 297**, page 159: The Lagrangian points L4 and L5 are on the orbit,  $60^\circ$  before and behind the orbiting body. They are stable if the mass ratio of the central and the orbiting body is sufficiently large (above 24.9)

**Challenge 298**, page 159: The Lagrangian point L3 is located on the orbit, but precisely on the other side of the central body. The Lagrangian point L1 is located on the line connecting the planet with the central body, whereas L2 lies outside the orbit, on the same line. If  $R$  is the radius of the orbit, the distance between the orbiting body and the L1 and L2 point is  $\sqrt[3]{m/3M} R$ , giving around



**FIGURE 240** The famous ‘vomit comet’, a KC-135, performing a parabolic flight (NASA).

4 times the distance of the Moon for the Sun-Earth system. L1, L2 and L3 are saddle points, but effectively stable orbits exist around them. Many satellites make use of these properties, including the famous WMAP satellite that measured the ripples of the big bang, which is located at L2.

**Challenge 299**, page 160: This is a resonance effect, in the same way that a small vibration of a string can lead to large oscillation of the air and sound box in a guitar.

**Challenge 301**, page 162: The expression for the strength of tides, namely  $2GM/d^3$ , can be rewritten as  $(8/3)\pi G\rho(R/d)^3$ . Now,  $R/d$  is roughly the same for Sun and Moon, as every eclipse shows. So the density  $\rho$  must be much larger for the Moon. In fact, the ratio of the strengths (height) of the tides of Moon and Sun is roughly 7 : 3. This is also the ratio between the mass densities of the two bodies.

**Challenge 302**, page 163: The total angular momentum of the Earth and the Moon must remain constant.

**Challenge 306**, page 165: Unfortunately, the myth of ‘passive gravitational mass’ is spread by many books. Careful investigation shows that it is measured in exactly the same way as inertial mass. The two concepts are identical.

**Challenge 307**, page 166: Either they fell on inclined snowy mountain sides, or they fell into high trees, or other soft structures. The record was over 7 km of survived free fall. A recent case made the news in 2007 and is told in [www.bbc.co.uk/jersey/content/articles/2006/12/20/michael\\_holmes\\_fall\\_feature.shtml](http://www.bbc.co.uk/jersey/content/articles/2006/12/20/michael_holmes_fall_feature.shtml).

**Challenge 309**, page 167: For a few thousand Euros, you can experience zero-gravity in a parabolic flight, such as the one shown in [Figure 240](#). (Many ‘photographs’ of parabolic flights found on the internet are in fact computer graphics. What about this one?)

How does zero-gravity *feel*? It feels similar to floating under water, but without the resistance of the water.

**Challenge 310**, page 167: The centre of mass of a broom falls with the usual acceleration; the end thus falls faster.

**Challenge 311**, page 167: Just use energy conservation for the two masses of the jumper and the string. For more details, including the comparison of experimental measurements and theory, see N. DUBELAAR & R. BRANTJES, De valversnelling bij bungee-jumping, *Nederlands tijdschrift voor natuurkunde* 69, pp. 316–318, October 2003.

**Challenge 312**, page 167: About 1 ton.

**Challenge 313**, page 167: About 5 g.

**Challenge 314**, page 167: Your weight is roughly constant; thus the Earth must be round. On a flat Earth, the weight would change from place to place, depending on your distance from the border.

**Challenge 315**, page 168: Nobody ever claimed that the centre of mass is the same as the centre of gravity! The attraction of the Moon is negligible on the surface of the Earth.

**Challenge 317**, page 169: That is the mass of the Earth. Just turn the table on its head.

**Challenge 319**, page 169: The Moon will be about 1.25 times as far as it is now. The Sun then will slow down the Earth–Moon system rotation, this time due to the much smaller tidal friction from the Sun's deformation. As a result, the Moon will return to smaller and smaller distances to Earth. However, the Sun will have become a red giant by then, after having swallowed both the Earth and the Moon.

**Challenge 321**, page 169: As Galileo determined, for a swing (half a period) the ratio is  $\sqrt{2}/\pi$ . (See challenge 276). But not more than two, maybe three decimals of  $\pi$  can be determined in this way.

**Challenge 322**, page 170: Momentum conservation is not a hindrance, as any tennis racket has the same effect on the tennis ball.

**Challenge 323**, page 170: In fact, in velocity space, elliptic, parabolic and hyperbolic motions are all described by circles. In all cases, the hodograph is a circle.

Ref. 143

**Challenge 324**, page 170: This question is old (it was already asked in Newton's times) and deep. One reason is that stars are kept apart by rotation around the galaxy. The other is that galaxies are kept apart by the momentum they got in the big bang. Without the big bang, all stars would have collapsed together. In this sense, the big bang can be deduced from the attraction of gravitation and the immobile sky at night. We shall find out later that the darkness of the night sky gives a second argument for the big bang.

**Challenge 325**, page 171: The choice is clear once you notice that there is no section of the orbit which is concave towards the Sun. Can you show this?

**Challenge 326**, page 172: It would be a black hole; no light could escape. Black holes are discussed in detail in the chapter on general relativity.

Vol. II, page 237

**Challenge 327**, page 172: A handle of two bodies.

**Challenge 330**, page 172: Using a maximal jumping height of  $h = 0.5$  m on Earth and an estimated asteroid density of  $\rho = 3 \text{ Mg/m}^3$ , we get a maximum radius of  $R^2 = 3gh/4\pi G\rho$ , or  $R \approx 2.4$  km.

**Challenge 331**, page 173: The shape of an analemma at local noon is shown in **Figure 241**. The vertical extension of the analemma is due to the obliquity, i.e., the tilt of the Earth's axis (it is twice  $23.45^\circ$ ). The horizontal extension is due to the combination of the obliquity and of the ellipticity of the orbit around the Sun. Both effects change the speed of the Earth along its orbit, leading to changes of the position of the Sun at local noon during the course of the year. The asymmetrical position of the central crossing point The shape of the analemma is also built into the shadow pole of precision sundials.

**Challenge 332**, page 173: Capture of a fluid body is possible if it is split by tidal forces.

**Challenge 333**, page 174: The tunnel would be an elongated ellipse in the plane of the Equator, reaching from one point of the Equator to the point at the antipodes. The time of revolution would not change, compared to a non-rotating Earth. See A. J. SIMONSON, Falling down a hole through the Earth, *Mathematics Magazine* 77, pp. 171–188, June 2004.





**FIGURE 241** The analemma photographed, at local noon, from January to December 2002, at the Parthenon on Athen's Acropolis, and a precision sundial (© Anthony Ayiomamitis, Stefan Pietrzik).

**Challenge 335**, page 175: The centre of mass of the solar system can be as far as twice the radius from the centre of the Sun; it thus can be outside the Sun.

**Challenge 336**, page 175: First, during northern summer time the Earth moves faster around the Sun than during northern winter time. Second, shallow Sun's orbits on the sky give longer days because of light from when the Sun is below the horizon.

**Challenge 337**, page 175: Apart from the visibility of the Moon, no effect on humans has ever been detected. Gravitational effects – including tidal effects – electrical effects, magnetic effects and changes in cosmic rays are all swamped by other effects. Indeed the gravity of passing trucks, factory electromagnetic fields, the weather and solar activity changes have larger influences on humans than the Moon. The locking of the menstrual cycle to the moon phase is a visual effect.

**Challenge 338**, page 175: Distances were difficult to measure. It is easy to observe a planet that is before the Sun, but it is hard to check whether a planet is behind the Sun.

**Challenge 339**, page 175: See the mentioned reference.

**Challenge 340**, page 175: True.

**Challenge 341**, page 175: For each pair of opposite shell elements (drawn in yellow), the two attractions compensate.

**Challenge 342**, page 176: There is no practical way; if the masses on the shell could move, along the surface (in the same way that charges can move in a metal) this might be possible, provided that enough mass is available.

**Challenge 345**, page 176: Yes, one could, and this has been thought of many times, including by Jules Verne. The necessary speed depends on the direction of the shot with respect of the rotation of the Earth.

**Challenge 346**, page 176: Never. The Moon points always towards the Earth. The Earth changes position a bit, due to the ellipticity of the Moon's orbit. Obviously, the Earth shows phases.

**Challenge 348**, page 177: What counts is *local* verticality; with respect to it, the river always flows downhill.

**Challenge 349**, page 177: There are no such bodies, as the chapter of general relativity will show.

**Challenge 351**, page 179: The oscillation is a purely sinusoidal, or harmonic oscillation, as the restoring force increases linearly with distance from the centre of the Earth. The period  $T$  for a homogeneous Earth is  $T = 2\pi\sqrt{R^3/GM} = 84 \text{ min.}$



**Challenge 352**, page 179: The period is the same for all such tunnels and thus in particular it is the same as the 84 min valid also for the pole to pole tunnel. See for example, R. H. ROMER, The answer is forty-two – many mechanics problems, only one answer, *Physics Teacher* 41, pp. 286–290, May 2003.

**Challenge 353**, page 179: There is no simple answer: the speed depends on the latitude and on other parameters.

**Challenge 354**, page 179: The centrifugal force must be equal to the gravitational force. Call the constant linear mass density  $d$  and the unknown length  $l$ . Then we have  $G M d \int_R^{R+l} dr/r^2 = \omega^2 d \int_R^{R+l} r dr$ . This gives  $G M d l / (R^2 + R l) = (2 R l + l^2) \omega^2 d / 2$ , yielding  $l = 0.14 \text{ Gm}$ .

**Challenge 356**, page 180: The inner rings must rotate faster than the outer rings. If the rings were solid, they would be torn apart. But this reasoning is true only if the rings are inside a certain limit, the so-called *Roche limit*. The Roche limit is that radius at which gravitational force  $F_g$  and tidal force  $F_t$  cancel on the surface of the satellite. For a satellite with mass  $m$  and radius  $r$ , orbiting a central mass  $M$  at distance  $d$ , we look at the forces on a small mass  $\mu$  on its surface. We get the condition  $G m \mu / r^2 = 2 G M \mu r / d^3$ . With a bit of algebra, one gets the Roche limit

$$d_{\text{Roche}} = R \left( 2 \frac{\rho_M}{\rho_m} \right)^{1/3}. \quad (142)$$

Below that distance from a central mass  $M$ , fluid satellites cannot exist. The calculation shown here is only an approximation; the actual Roche limit is about two times that value.

**Challenge 361**, page 184: In reality muscles keep an object above ground by continuously lifting and dropping it; that requires energy and work.

**Challenge 362**, page 184: The electricity consumption of a rising escalator indeed increases when the person on it walks upwards. By how much?

**Challenge 363**, page 184: Knowledge is power. Time is money. Now, power is defined as work per time. Inserting the previous equations and transforming them yields

$$\text{money} = \frac{\text{work}}{\text{knowledge}}, \quad (143)$$

which shows that the less you know, the more money you make. That is why scientists have low salaries.

**Challenge 366**, page 185: Yes, because side wind increases the effective speed  $v$  in air due to vector addition, and because air resistance is (roughly) proportional to  $v^2$ .

**Challenge 367**, page 187: The lack of static friction would avoid that the fluid stays attached to the body; the so-called boundary layer would not exist. One then would have to wing effect.

**Challenge 369**, page 188: True?

**Challenge 371**, page 188: From  $dv/dt = g - v^2(1/2c_w A \rho / m)$  and using the abbreviation  $c = 1/2c_w A \rho$ , we can solve for  $v(t)$  by putting all terms containing the variable  $v$  on one side, all terms with  $t$  on the other, and integrating on both sides. We get  $v(t) = \sqrt{gm/c} \tanh \sqrt{cg/m} t$ .

**Challenge 372**, page 190: For extended deformable bodies, the intrinsic properties are given by the mass density – thus a function of space and time – and the state is described by the density of kinetic energy, linear and angular momentum, as well as by its stress and strain distributions.

**Challenge 373**, page 190: The phase space has  $3N$  position coordinates and  $3N$  momentum coordinates.

**Challenge 374**, page 190: The light mill is an example.

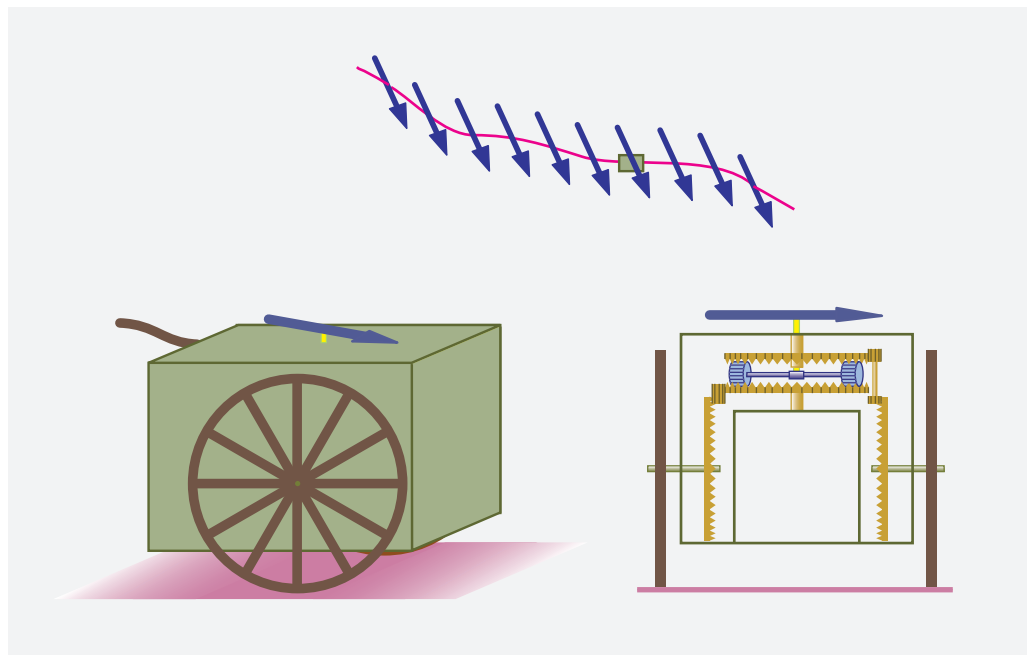


FIGURE 242 The mechanism inside the south-pointing carriage.

**Challenge 375**, page 190: Electric charge.

**Challenge 376**, page 191: If you have found reasons to answer yes, you overlooked something. Just go into more details and check whether the concepts you used apply to the universe. Also define carefully what you mean by ‘universe’.

**Challenge 378**, page 192: A system showing energy or matter motion faster than light would imply that for such systems there are observers for which the order between cause and effect are reversed. A space-time diagram (and a bit of exercise from the section on special relativity) shows this.

**Challenge 379**, page 193: If reproducibility would not exist, we would have difficulties in checking observations; also reading the clock is an observation. The connection between reproducibility and time shall become important in the final part of our adventure.

**Challenge 380**, page 194: Even if surprises were only rare, each surprise would make it impossible to define time just before and just after it.

**Challenge 383**, page 194: Of course; moral laws are summaries of what others think or will do about personal actions.

**Challenge 384**, page 195: The fastest glide path between two points, the *brachistochrone*, turns out to be the *cycloid*, the curve generated by a point on a wheel that is rolling along a horizontal plane.

The proof can be found in many ways. The simplest is by Johann Bernoulli and is given on [en.wikipedia.org/wiki/Brachistochrone\\_problem](https://en.wikipedia.org/wiki/Brachistochrone_problem).

**Challenge 387**, page 196: Figure 242 shows the most credible reconstruction of a south-pointing carriage.

**Challenge 388**, page 197: The water is drawn up along the sides of the spinning egg. The fastest way to empty a bottle of water is to spin the water while emptying it.

**Challenge 390**, page 197: The right way is the one where the chimney falls like a V, not like an inverted V. See challenge 310 on falling brooms for inspiration on how to deduce the answer. It turns out that the chimney breaks (if it is not fastened to the base) at a height between half or two thirds of the total, depending at the angle at which this happens. For a complete solution of the problem, see the excellent paper G. VARESCHI & K. KAMIYA, Toy models for the falling chimney, *American Journal of Physics* 71, pp. 1025–1031, 2003.

**Challenge 398**, page 206: In one dimension, the expression  $F = ma$  can be written as  $-dV/dx = md^2x/dt^2$ . This can be rewritten as  $d(-V)/dx - d/dt[d/dx(\frac{1}{2}m\dot{x}^2)] = 0$ . This can be expanded to  $\partial/\partial x(\frac{1}{2}m\dot{x}^2 - V(x)) - d/dt[\partial/\partial \dot{x}(\frac{1}{2}m\dot{x}^2 - V(x))] = 0$ , which is Lagrange's equation for this case.

**Challenge 400**, page 206: Do not despair. Up to now, nobody has been able to imagine a universe (that is not necessarily the same as a 'world') different from the one we know. So far, such attempts have always led to logical inconsistencies.

**Challenge 402**, page 207: The two are equivalent since the equations of motion follow from the principle of minimum action and at the same time the principle of minimum action follows from the equations of motion.

**Challenge 404**, page 208: For gravity, all three systems exist: rotation in galaxies, pressure in planets and the Pauli pressure in stars. Against the strong interaction, the Pauli principle acts in nuclei and neutron stars; in neutron stars maybe also rotation and pressure complement the Pauli pressure. But for the electromagnetic interaction there are no composites other than our everyday matter, which is organized by the Pauli principle alone.

**Challenge 406**, page 211: Angular momentum is the change with respect to angle, whereas rotational energy is again the change with respect to time, as all energy is.

**Challenge 407**, page 211: Not in this way. A small change can have a large effect, as every switch shows. But a small change in the brain must be communicated outside, and that will happen roughly with a  $1/r^2$  dependence. That makes the effects so small, that even with the most sensitive switches – which for thoughts do not exist anyway – no effects can be realized.

**Challenge 410**, page 213: The relation is

$$\frac{c_1}{c_2} = \frac{\sin \alpha_1}{\sin \alpha_2} . \quad (144)$$

The particular speed ratio between air (or vacuum, which is almost the same) and a material gives the *index of refraction*  $n$ :

$$n = \frac{c_1}{c_0} = \frac{\sin \alpha_1}{\sin \alpha_0} \quad (145)$$

**Challenge 411**, page 213: Gases are mainly made of vacuum. Their index of refraction is near to one.

**Challenge 412**, page 213: Diamonds also sparkle because they work as prisms; different colours have different indices of refraction. Thus their sparkle is also due to their dispersion; therefore it is a mix of all colours of the rainbow.

**Challenge 413**, page 213: The principle for the growth of trees is simply the minimum of potential energy, since the kinetic energy is negligible. The growth of vessels inside animal bodies is minimized for transport energy; that is again a minimum principle. The refraction of light is the path of shortest time; thus it minimizes change as well, if we imagine light as moving entities moving without any potential energy involved.

**Challenge 414**, page 213: Special relativity requires that an invariant measure of the action exist. It is presented later in the walk.

**Challenge 415**, page 214: The universe is not a physical system. This issue will be discussed in detail later on.

Vol. VI, page 97

**Challenge 416**, page 214: Use either the substitution  $u = \tan t/2$  or use the historical trick

$$\sec \varphi = \frac{1}{2} \left( \frac{\cos \varphi}{1 + \sin \varphi} + \frac{\cos \varphi}{1 - \sin \varphi} \right). \quad (146)$$

**Challenge 417**, page 214: A skateboarder in a cycloid has the same oscillation time independently of the oscillation amplitude. But a half-pipe needs to have vertical ends, in order to avoid jumping outside it. A cycloid never has a vertical end.

**Challenge 418**, page 215: We talk to a person because we know that somebody understands us. Thus we assume that she somehow sees the same things we do. That means that observation is partly viewpoint-independent. Thus nature is symmetric.

**Challenge 419**, page 219: Memory works because we recognize situations. This is possible because situations over time are similar. Memory would not have evolved without this reproducibility.

**Challenge 420**, page 220: Taste differences are not fundamental, but due to different viewpoints and – mainly – to different experiences of the observers. The same holds for feelings and judgments, as every psychologist will confirm.

**Challenge 421**, page 221: The integers under addition form a group. Does a painter's set of oil colours with the operation of mixing form a group?

**Challenge 422**, page 221: There is only one symmetry operation: a rotation about  $\pi$  around the central point. That is the reason that later on the group  $D_4$  is only called the approximate symmetry group of [Figure 156](#).

**Challenge 428**, page 225: Scalar is the magnitude of any vector; thus the speed, defined as  $v = |\boldsymbol{v}|$ , is a scalar, whereas the velocity  $\boldsymbol{v}$  is not. Thus the length of any vector (or pseudovector), such as force, acceleration, magnetic field, or electric field, is a scalar, whereas the vector itself is not a scalar.

**Challenge 431**, page 226: The charge distribution of an extended body can be seen as a sum of a charge, a charge dipole, a charge quadrupole, a charge octupole, etc. The quadrupole is described by a tensor.

Compare: The inertia against motion of an extended body can be seen as sum of a mass, a mass dipole, a mass quadrupole, a mass octupole, etc. The mass quadrupole is described by the moment of inertia.

**Challenge 435**, page 228: The conserved charge for rotation invariance is angular momentum.

**Challenge 438**, page 231: An oscillation has a period in time, i.e., a discrete time translation symmetry. A wave has both discrete time and discrete space translation symmetry.

**Challenge 439**, page 231: Motion reversal is a symmetry for any closed system; despite the observations of daily life, the statements of thermodynamics and the opinion of several famous physicists (who form a minority though) all ideally closed systems are reversible.

**Challenge 451**, page 240: The potential energy is due to the 'bending' of the medium; a simple displacement produces no bending and thus contains no energy. Only the gradient captures the bending idea.

**Challenge 453**, page 240: The phase changes by  $\pi$ .

**Challenge 455**, page 241: Waves can be damped to extremely low intensities. If this is not possible, the observation is not a wave.

**Challenge 456**, page 242: The way to observe diffraction and interference with your naked fingers is told on page 87.

**Challenge 463**, page 253: Skiers scrape snow from the lower side of each bump towards the upper side of the next bump. This leads to an upward motion of ski bumps.

**Challenge 464**, page 253: If the distances to the loudspeaker is a few metres, and the distance to the orchestra is 20 m, as for people with enough money, the listener at home hears it first.

**Challenge 466**, page 253: In general, the body moves along an ellipse (as for planets around the Sun) but with the fixed point as centre. In contrast to planets, where the Sun is in a *focus* of the ellipse and there is a perihelium and an aphelium, such a body moves *symmetrically* around the *centre* of the ellipse. In special cases, the body moves back and forward along a straight segment.

**Challenge 469**, page 254: The sound of thunder or of car traffic gets lower and lower in frequency with increasing distance.

**Challenge 471**, page 254: Neither; both possibilities are against the properties of water: in surface waves, the water molecules move in circles.

**Challenge 472**, page 255: Swimmers are able to cover 100 m in 48 s, or slightly better than 2 m/s. (Swimmer with fins achieve just over 3 m/s.) With a body length of about 1.9 m, the critical speed is 1.7 m/s. That is why short distance swimming depends on training; for longer distances the technique plays a larger role, as the critical speed has not been attained yet. The formula also predicts that on the 1500 m distance, a 2 m tall swimmer has a potential advantage of over 45 s on one with body height of 1.8 m. In addition, longer swimmers have an additional advantage: they swim shorter distances in pools (why?). It is thus predicted that successful long-distance swimmers will get taller and taller over time. This is a pity for a sport that so far could claim to have had champions of all sizes and body shapes, in contrast to many other sports.

**Challenge 474**, page 256: To reduce noise reflection and thus hall effects. They effectively diffuse the arriving wave fronts.

**Challenge 476**, page 256: Waves in a river are never elliptical; they remain circular.

**Challenge 477**, page 256: The lens is a cushion of material that is 'transparent' to sound. The speed of sound is faster in the cushion than in the air, in contrast to a glass lens, where the speed of light is slower in the glass. The shape is thus different: the cushion must look like a biconcave lens.

**Challenge 478**, page 256: Experiments show that the sound does not depend on air flows (find out how), but does depend on external sound being present. The sound is due to the selective amplification by the resonances resulting from the geometry of the shell shape.

**Challenge 479**, page 256: The Sun is always at a different position than the one we observe it to be. What is the difference, measured in angular diameters of the Sun?

**Challenge 480**, page 257: The  $3 \times 3 \times 3$  cube has a rigid system of three perpendicular axes, on which a square can rotate at each of the 6 ends. The other squares are attached to pieces moving around these axes. The  $4 \times 4 \times 4$  cube is different though; just find out. The limit on the segment number seems to be 6, so far. A  $7 \times 7 \times 7$  cube requires varying shapes for the segments. But more than  $5 \times 5 \times 5$  is not found in shops. On the other hand, the website [www.oinkleburger.com/Cube/applet](http://www.oinkleburger.com/Cube/applet) allows playing with virtual cubes up to  $100 \times 100 \times 100$ , and more.

**Challenge 482**, page 258: An overview of systems being tested at present can be found in K. - U. GRAW, Energiereservoir Ozean, *Physik in unserer Zeit* 33, pp. 82–88, Februar 2002. See also Oceans of electricity – new technologies convert the motion of waves into watts, *Science News* 159, pp. 234–236, April 2001.

**Challenge 483**, page 258: In everyday life, the assumption is usually justified, since each spot can be approximately represented by an atom, and atoms can be followed. The assumption is

questionable in situations such as turbulence, where not all spots can be assigned to atoms, and most of all, in the case of motion of the vacuum itself. In other words, for gravity waves, and in particular for the quantum theory of gravity waves, the assumption is not justified.

**Challenge 487**, page 263: There are many. One would be that the transmission and thus reflection coefficient for waves would almost be independent of wavelength.

**Challenge 488**, page 264: A drop with a diameter of 3 mm would cover a surface of  $7.1 \text{ m}^2$  with a 2 nm film.

**Challenge 490**, page 268: The critical height for a column of material is given by  $h_{\text{crit}}^4 = \frac{\beta}{4\pi g} m \frac{E}{\rho^2}$ , where  $\beta \approx 1.9$  is the constant determined by the calculation when a column buckles under its own weight.

**Challenge 493**, page 271: One possibility is to describe particles as clouds; another is given in the last part of the text.

**Challenge 495**, page 275: The constant  $k$  follows from the conservation of energy and that of mass:  $k = \sqrt{2/(\rho(A_1^2/A_2^2 - 1))}$ . The cross sections are denoted by  $A$  and the subscript 1 refers to any point far from the constriction, and the subscript 2 to the constriction.

**Challenge 496**, page 277: Some people notice that in some cases friction is too high, and start sucking at one end of the tube to get the flow started; while doing so, they can inhale or swallow gasoline, which is poisonous.

**Challenge 502**, page 278: The blood pressure in the feet of a standing human is about 27 kPa, double the pressure at the heart.

**Challenge 503**, page 278: Calculation gives  $N = J/j = 0.0001 \text{ m}^3/\text{s}/(7 \mu\text{m}^2 \cdot 0.0005 \text{ m/s})$ , or about  $6 \cdot 10^9$ ; in reality, the number is much larger, as most capillaries are closed at a given instant. The reddening of the face shows what happens when all small blood vessels are opened at the same time.

**Challenge 504**, page 278: Throwing the stone makes the level fall, throwing the water or the piece of wood leaves it unchanged.

**Challenge 505**, page 278: The ship rises higher into the sky. (Why?)

**Challenge 509**, page 279: The pumps worked in suction; but air pressure only allows 10 m of height difference for such systems.

**Challenge 510**, page 279: This argument is comprehensible only when one remembers that 'twice the amount' means 'twice as many molecules'.

**Challenge 511**, page 279: The alcohol is frozen and the chocolate is put around it.

**Challenge 512**, page 279: The author suggested in an old edition that a machine should be based on the same machines that throw the clay pigeons used in the sports of trap shooting and skeet. In the meantime, Lydéric Bocquet and Christophe Clanet have built such a machine, but using a different design; a picture can be found on the website [lpmcn.univ-lyon1.fr/%7Elbocquet](http://lpmcn.univ-lyon1.fr/%7Elbocquet).

**Challenge 513**, page 280: The third component of *air* is the noble gas argon, making up about 1%. A longer list of components is given in Table 57.

**Challenge 514**, page 280: The pleural cavity between the lungs and the thorax is permanently below atmospheric pressure. A hole in it, formed for example by a bullet, a sword or an accident, leads to the collapse of the lung – the so-called *pneumothorax* – and often to death. Open chest operations on people have become possible only after the surgeon Ferdinand Sauerbruch learned in 1904 how to cope with the problem. Nowadays, surgeons keep the lung under higher than atmospheric pressure until everything is sealed again.

**Challenge 515**, page 280: It uses the air pressure created by the water flowing downwards.

TABLE 57 Gaseous composition of dry air, at present time<sup>a</sup> (sources: NASA, IPCC).

G A S	S Y M B O L	V O L U M E P A R T <sup>b</sup>
Nitrogen	N <sub>2</sub>	78.084 %
Oxygen	O <sub>2</sub>	20.946 %
Argon	Ar	0.934 %
Carbon dioxide (in large part due to human pollution)	CO <sub>2</sub>	387 ppm
Neon	Ne	18.18 ppm
Helium	He	5.24 ppm
Methane (mostly due to human pollution)	CH <sub>4</sub>	1.79 ppm
Krypton	Kr	1.14 ppm
Hydrogen	H <sub>2</sub>	0.55 ppm
Nitrous oxide (mostly due to human pollution)	N <sub>2</sub> O 0.3 ppm	
Carbon monoxide (partly due to human pollution)	CO	0.1 ppm
Xenon	Xe	0.087 ppm
Ozone (strongly influenced by human pollution)	O <sub>3</sub>	0 to 0.07 ppm
Nitrogen dioxide (mostly due to human pollution)	NO <sub>2</sub>	0.02 ppm
Iodine	I <sub>2</sub>	0.01 ppm
Ammonia (mostly due to human pollution)	NH <sub>3</sub>	traces
Radon	Ra	traces
Halocarbons and other fluorine compounds (all being humans pollutants)	20 types	0.0012 ppm
Mercury, other metals, sulfur compounds, other organic compounds (all being human pollutants)	numerous	concentration varies

a. Wet air can contain up to 4% water vapour, depending on the weather. *Apart from gases*, air can contain water droplets, ice, sand, dust, pollen, spores, volcanic ash, forest fire ash, fuel ash, smoke particles, meteoroids and cosmic ray particles. *During the history* of the Earth, the gaseous composition varied strongly.

b. The abbreviation *ppm* means 'part per million'.

**Challenge 516**, page 280: Yes. The bulb will not resist two such cars though.

**Challenge 517**, page 280: Radon is about 8 times as heavy as air; it is the densest gas known. In comparison, Ni(CO) is 6 times, SiCl<sub>4</sub> 4 times heavier than air. Mercury vapour (obviously also a gas) is 7 times heavier than air. In comparison, bromine vapour is 5.5 times heavier than air.

**Challenge 519**, page 281: None.

**Challenge 521**, page 281: He brought the ropes into the cabin by passing them through liquid mercury.

**Challenge 522**, page 281: The pressure destroys the lung.

**Challenge 524**, page 281: There are no official solutions for these questions; just check your assumptions and calculations carefully. The internet is full of such calculations.

**Challenge 525**, page 282: The soap flows down the bulb, making it thicker at the bottom and thinner at the top, until it bursts.



**Challenge 527**, page 282: For this to happen, friction would have to exist on the microscopic scale and energy would have to disappear.

**Challenge 526**, page 282: The temperature leads to evaporation of the involved liquid, and the vapour prevents the direct contact between the two non-gaseous bodies.

**Challenge 528**, page 282: The longer funnel is empty before the short one. (If you do not believe it, try it out.) In the case that the amount of water in the funnel outlet can be neglected, one can use energy conservation for the fluid motion. This yields the famous Bernoulli equation  $p/\rho + gh + v^2/2 = \text{const}$ , where  $p$  is pressure,  $\rho$  the density of water, and  $g$  is  $9.81 \text{ m/s}^2$ . Therefore, the speed  $v$  is higher for greater lengths  $h$  of the thin, straight part of the funnel: the longer funnel empties first.

But this is strange: the formula gives a simple free fall relation, as the *air* pressure is the same above and below and disappears from the calculation. The expression for the speed is thus independent of whether a tube is present or not. The real reason for the faster emptying of the tube is thus that a tube forces more water to flow out than the lack of a tube. Without tube, the diameter of the water flow *diminishes* during fall. With tube, it stays *constant*. This difference leads to the faster emptying for longer tubes.

Alternatively, you can look at the *water* pressure value *inside* the funnel. You will discover that the water pressure is lowest at the start of the exit tube. This internal water pressure is lower for longer tubes and sucks out the water faster in those cases.

**Challenge 529**, page 282: The eyes of fish are positioned in such a way that the pressure reduction by the flow is compensated by the pressure increase of the stall. By the way, their heart is positioned in such a way that it is helped by the underpressure.

**Challenge 531**, page 283: This feat has been achieved for lower mountains, such as the Monte Bianco in the Alps. At present however, there is no way to safely hover at the high altitudes of the Himalayas.

**Challenge 533**, page 283: Press the handkerchief in the glass, and lower the glass into the water with the opening first, while keeping the opening horizontal. This method is also used to lower people below the sea. The paper ball in the bottle will fly towards you. Blowing into a funnel will keep the ping-pong ball tightly into place, and the more so the stronger you blow. Blowing through a funnel towards a candle will make it lean towards you.

**Challenge 538**, page 285: Glass shatters, glass is elastic, glass shows transverse sound waves, glass does not flow (in contrast to what many books state), not even on scale of centuries, glass molecules are fixed in space, glass is crystalline at small distances, a glass pane supported at the ends does not hang through.

**Challenge 539**, page 285: No metal wire allows building such a long wire. Only the idea of carbon nanotubes has raised the hope again; some dream of wire material based on them, stronger than any material known so far. However, no such material is known yet. The system faces many dangers, such as fabrication defects, lightning, storms, meteorites and space debris. All would lead to the breaking of the wires – if such wires will ever exist. But the biggest of all dangers is the lack of cash to build it.

**Challenge 541**, page 286: A medium-large earthquake would be generated.

**Challenge 542**, page 286: A stalactite contains a thin channel along its axis through which the water flows, whereas a stalagmite is massive throughout.

**Challenge 543**, page 286: About 1 part in a thousand.

**Challenge 544**, page 286: Even though the iron core of the Earth formed by collecting the iron from colliding asteroids which then sunk into the centre of the Earth, the scheme will not work today: in its youth, the Earth was much more liquid than today. The iron will most probably not

sink. In addition, there is no known way to build a measurement probe that can send strong enough sound waves for this scheme. The temperature resistance is also an issue, but this may be solvable.

**Challenge 546**, page 288: Atoms are not infinitely hard, as quantum theory shows. Atoms are more similar to deformable clouds.

Vol. IV, page 66

**Challenge 550**, page 296: In 5000 million years, the present method will stop, and the Sun will become a red giant. But it will burn for many more years after that.

**Challenge 551**, page 298: The possibility of motion inversion for all observed phenomena is indeed a fundamental property of nature. It has been confirmed for all interactions and all experiments every performed. Independent of this is the fact, that realizing the inversion might be extremely hard, because inverting the motion of many atoms is often not feasible.

**Challenge 555**, page 301: We will find out later that the universe is not a physical system; thus the concept of entropy does not apply to it. Thus the universe is neither isolated nor closed.

Vol. VI, page 97

**Challenge 558**, page 302: The answer depends on the size of the balloons, as the pressure is not a monotonous function of the size. If the smaller balloon is not too small, the smaller balloon wins.

**Challenge 560**, page 302: Measure the area of contact between tires and street (all four) and then multiply by 200 kPa, the usual tire pressure. You get the weight of the car.

**Challenge 565**, page 304: If the average square displacement is proportional to time, the liquid is made of smallest particles. This was confirmed by the experiments of Jean Perrin. The next step is to deduce the number of these particles from the proportionality constant. This constant, defined by  $\langle d^2 \rangle = 4Dt$ , is called the diffusion constant (the factor 4 is valid for random motion in two dimensions). The diffusion constant can be determined by watching the motion of a particle under the microscope.

We study a Brownian particle of radius  $a$ . In two dimensions, its square displacement is given by

$$\langle d^2 \rangle = \frac{4kT}{\mu} t, \quad (147)$$

where  $k$  is the Boltzmann constant and  $T$  the temperature. The relation is deduced by studying the motion of a particle with drag force  $-\mu v$  that is subject to random hits. The linear drag coefficient  $\mu$  of a sphere of radius  $a$  is given by

$$\mu = 6\pi\eta a. \quad (148)$$

In other words, one has

$$k = \frac{6\pi\eta a}{4T} \frac{\langle d^2 \rangle}{t}. \quad (149)$$

All quantities on the right can be measured, thus allowing to determine the Boltzmann constant  $k$ . Since the ideal gas relation shows that the ideal gas constant  $R$  is related to the Boltzmann constant by  $R = N_A k$ , the Avogadro constant  $N_A$  that gives the number of molecules in a mole is also found in this way.

**Challenge 573**, page 311: Egg white starts to harden at lower temperature than yolk, but for complete hardening, the opposite is true. White hardens *completely* at 80°C, egg yolk hardens considerably at 66 to 68°C. Cook an egg at the latter temperature, and the feat is possible; the white remains runny, but does not remain transparent, though. Note again that the cooking time plays no role, only the precise temperature value.

**Challenge 575**, page 311: Yes, the effect is easily noticeable.

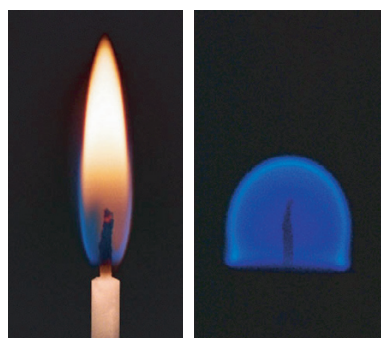


FIGURE 243 A candle on Earth and in microgravity (NASA).

**Challenge 577**, page 312: Hot air is less dense and thus wants to rise.

**Challenge 578**, page 312: Keep the paper wet.

**Challenge 580**, page 312: The air had to be dry.

**Challenge 581**, page 312: In general, it is impossible to draw a line through three points. Since absolute zero and the triple point of water are fixed in magnitude, it was practically a sure bet that the boiling point would not be at precisely  $100^{\circ}\text{C}$ .

**Challenge 582**, page 312: No, as a water molecule is heavier than that. However, if the water is allowed to be dirty, it is possible. What happens if the quantum of action is taken into account?

**Challenge 583**, page 312: The danger is not due to the amount of energy, but due to the time in which it is available.

**Challenge 584**, page 313: The internet is full of solutions.

**Challenge 586**, page 313: Only if it is a closed system. Is the universe closed? Is it a system? This is discussed in the final part of the mountain ascent.

**Challenge 589**, page 314: For such small animals the body temperature would fall too low. They could not eat fast enough to get the energy needed to keep themselves warm.

**Challenge 598**, page 315: It is about  $10^{-9}$  that of the Earth.

**Challenge 600**, page 315: The thickness of the folds in the brain, the bubbles in the lung, the density of blood vessels and the size of biological cells.

**Challenge 601**, page 315: The mercury vapour above the liquid gets saturated.

**Challenge 602**, page 315: A dedicated NASA project studied this question. [Figure 243](#) gives an example comparison. You can find more details on their website.

**Challenge 603**, page 316: The risks due to storms and the financial risks are too high.

**Challenge 604**, page 316: The vortex inside the tube is cold near its axis and hot in the regions away from the axis. Through the membrane in the middle of the tube (shown in [Figure 211](#) on [page 316](#)) the air from the axis region is sent to one end and the air from the outside region to the other end. The heating of the outside region is due to the work that the air rotating inside has to do on the air outside to get a rotation that consumes angular momentum. For a detailed explanation, see the beautiful text by MARK P. SILVERMAN, *And Yet it Moves: Strange Systems and Subtle Questions in Physics*, Cambridge University Press, 1993, p. 221.

**Challenge 608**, page 317: In the case of water, a few turns mixes the ink, and turning backwards increases the mixing. In the case of glycerine, a few turns *seems* to mix the ink, and turning backwards undoes the mixing.

**Challenge 610**, page 317: Negative temperatures are a conceptual crutch definable only for systems with a few discrete states; they are not real temperatures, because they do not describe equilibrium states, and indeed never apply to systems with a continuum of states.

**Challenge 611**, page 318: This is also true for the shape human bodies, the brain control of human motion, the growth of flowers, the waves of the sea, the formation of clouds, the processes leading to volcano eruptions, etc.

**Challenge 613**, page 321: See the puzzle about the motion of ski moguls.

**Challenge 617**, page 324: First, there are many more butterflies than tornadoes. Second, tornadoes do not rely on small initial disturbances for their appearance. Third, the belief in the butterfly 'effect' completely neglects an aspect of nature that is essential for self-organization: friction and dissipation. The butterfly 'effect', assumed that it existed, would require that dissipation in the air should have completely unrealistic properties. This is not the case in the atmosphere. But most important of all, there is no experimental basis for the 'effect': it has never been observed. Thus it does not exist.

**Challenge 628**, page 333: All three statements are hogwash. A drag coefficient implies that the cross area of the car is known to the same precision. This is actually extremely difficult to measure and to keep constant. In fact, the value 0.375 for the Ford Escort was a cheat, as many other measurements showed. The fuel consumption is even more ridiculous, as it implies that fuel volumes and distances can be measured to that same precision. Opinion polls are taken by phoning at most 2000 people; due to the difficulties in selecting the right representative sample, that gives a precision of at most 3 %.

**Challenge 629**, page 333: No. Nature does not allow more than about 20 digits of precision, as we will discover later in our walk. That is not sufficient for a standard book. The question whether such a number can be part of its own book thus disappears.

**Challenge 631**, page 334: Space-time is defined using matter; matter is defined using space-time.

**Challenge 632**, page 334: Fact is that physics has been based on a circular definition for hundreds of years. Thus it is possible to build even an exact science on sand. Nevertheless, the elimination of the circularity is an important aim.

**Challenge 633**, page 335: Every measurement is a comparison with a standard; every comparison requires light or some other electromagnetic field. This is also the case for time measurements.

**Challenge 634**, page 335: Every mass measurement is a comparison with a standard; every comparison requires light or some other electromagnetic field.

**Challenge 635**, page 335: Angle measurements have the same properties as length or time measurements.

**Challenge 640**, page 351: About 10  $\mu\text{g}$ .

**Challenge 641**, page 351: Since the temperature of the triple point of water is fixed, the temperature of the boiling point is fixed as well. Historically, the value of the triple point has not been well chosen.

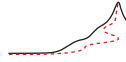
**Challenge 642**, page 352: Probably the quantity with the biggest variation is mass, where a prefix for  $1 \text{ eV}/c^2$  would be useful, as would be one for the total mass in the universe, which is about  $10^{90}$  times larger.

**Challenge 643**, page 352: The formula with  $n - 1$  is a better fit. Why?

**Challenge 647**, page 357: No, only properties of parts of the universe are listed. The universe itself has no properties, as shown in the last volume..

**Challenge 646**, page 357: The slowdown goes *quadratically* with time, because every new slowdown adds to the old one!

**Challenge 648**, page 408: For example, speed inside materials is slowed, but between atoms, light still travels with vacuum speed.





# BIBLIOGRAPHY

“ Aiunt enim multum legendum esse, non multa. ”  
Plinius, *Epistulae*.\*

- 1 For a history of science in antiquity, see LUCIO RUSSO, *La rivoluzione dimenticata*, Feltrinelli 1996, also available in several other languages. Cited on page 14.
- 2 If you want to catch up secondary school physics, the clearest and shortest introduction world-wide is a free school text, available in English and many other languages, written by a researcher who has dedicated all his life to the teaching of physics in secondary school, together with his university team: FRIEDRICH HERRMANN, *The Karlsruhe Physics Course*, free to download in English, Spanish, Russian and Italian at [www.physikdidaktik.uni-karlsruhe.de](http://www.physikdidaktik.uni-karlsruhe.de). It is one of the few secondary school texts that captivates, surprises and challenges even professional physicists. This can be said even more of the wonderfully daring companion book FRIEDRICH HERRMANN & GEORG JOB, *Atlanten der Physik*, Aulis Verlag Deubner, 2002, whose content is available for free, in German, on the same site.

A beautiful book explaining physics and its many applications in nature and technology vividly and thoroughly is PAUL G. HEWITT, JOHN SUCHOCKI & LESLIE A. HEWITT, *Conceptual Physical Science*, Benjamin/Cummings, 1999.

A book famous for its passion for curiosity is RICHARD P. FEYNMAN, ROBERT B. LEIGHTON & MATTHEW SANDS, *The Feynman Lectures on Physics*, Addison Wesley, 1977.

A lot can be learned about motion from quiz books. One of the best is the well-structured collection of beautiful problems that require no mathematics, written by JEAN-MARC LÉVY-LEBLOND, *La physique en questions – mécanique*, Vuibert, 1998.

Another excellent quiz collection is YAKOV PERELMAN, *Oh, la physique*, Dunod, 2000, a translation from the Russian original.

A good problem book is W. G. REES, *Physics by Example: 200 Problems and Solutions*, Cambridge University Press, 1994.

A good history of physical ideas is given in the excellent text by DAVID PARK, *The How and the Why*, Princeton University Press, 1988.

An excellent introduction into physics is ROBERT POHL, *Pohl's Einführung in die Physik*, Klaus Lüders & Robert O. Pohl editors, Springer, 2004, in two volumes with CDs. It is a new edition of a book that is over 70 years old; but the didactic quality, in particular of the experimental side of physics, is unsurpassed.

---

\* 'Read much, but not anything' Ep. 7, 9, 15. Gaius Plinius Secundus (b. 23/4 Novum Comum, d. 79 Vesuvius eruption), Roman writer, especially famous for his large, mainly scientific work *Historia naturalis*, which has been translated and read for almost 2000 years.

Another excellent Russian physics problem book, the so-called *Saraeva*, seems to exist only as Portuguese translation: B. B. BÚJOVTSEV, V. D. KRÍVCHENKOV, G. YA. MIÁK-ISHEV & I. M. SARÁEVA *Problemas seleccionados de física elemental*, Mir, 1979.

Another good physics problem book is GIOVANNI TONZIG, *Cento errori di fisica pronti per l'uso*, Sansoni, third edition, 2006. See also his [www.giovannitonzig.it](http://www.giovannitonzig.it) website. Cited on pages 14, 105, 176, and 256.

- 3 An overview of motion illusions can be found on the excellent website [www.michaelbach.de/ot](http://www.michaelbach.de/ot). The complex motion illusion figure is found on [www.michaelbach.de/ot/mot\\_rotsnake/index.html](http://www.michaelbach.de/ot/mot_rotsnake/index.html); it is a slight variation of the original by Kitaoka Akiyoshi at [www.ritsumei.ac.jp/~akitaoka/rotsnake.gif](http://www.ritsumei.ac.jp/~akitaoka/rotsnake.gif), published as A. KITAOKA & H. ASHIDA, Phenomenal characteristics of the peripheral drift illusion, *Vision* 15, pp. 261–262, 2003. A famous scam is to pretend that the illusion is due to or depends on stress. Cited on page 15.
- 4 These and other fantastic illusions are also found in AKIYOSHI KITAOKA, *Trick Eyes*, Barnes & Noble, 2005. Cited on page 15.
- 5 A well-known principle in the social sciences states that, given a question, for every possible answer, however weird it may seem, there is somebody – and often a whole group – who holds it as his opinion. One just has to go through literature (or the internet) to confirm this.  
About group behaviour in general, see R. AXELROD, *The Evolution of Cooperation*, Harper Collins, 1984. The propagation and acceptance of ideas, such as those of physics, are also an example of human cooperation, with all its potential dangers and weaknesses. Cited on page 15.
- 6 All the known texts by Parmenides and Heraclitus can be found in JEAN-PAUL DUMONT, *Les écoles présocratiques*, Folio-Gallimard, 1988. Views about the non-existence of motion have also been put forward by much more modern and much more contemptible authors, such as in 1710 by Berkeley. Cited on page 16.
- 7 An example of people worried by Zeno is given by WILLIAM MCLAUGHLIN, Resolving Zeno's paradoxes, *Scientific American* pp. 66–71, November 1994. The actual argument was not about a hand slapping a face, but about an arrow hitting the target. See also Ref. 59. Cited on page 16.
- 8 The full text of *La Beauté* and the other poems from *Les fleurs du mal*, one of the finest books of poetry ever written, can be found at the [hypermedia.univ-paris8.fr/bibliotheque/Baudelaire/Spleen.html](http://hypermedia.univ-paris8.fr/bibliotheque/Baudelaire/Spleen.html) website. Cited on page 17.
- 9 The most famous text is JEARL WALKER, *The Flying Circus of Physics*, Wiley, 1975. For more interesting physical effects in everyday life, see ERWEIN FLACHSEL, *Hundertfünfzig Physikrätsel*, Ernst Klett Verlag, 1985. The book also covers several clock puzzles, in puzzle numbers 126 to 128. Cited on page 18.
- 10 A concise and informative introduction into the history of classical physics is given in the first chapter of the book by FLOYD KARKER RICHTMYER, EARLE HESSE KENNARD & JOHN N. COOPER, *Introduction to Modern Physics*, McGraw-Hill, 1969. Cited on page 19.
- 11 An introduction into perception research is BRUCE GOLDSTEIN, *Perception*, Books/Cole, 5th edition, 1998. Cited on pages 20 and 24.
- 12 A good overview over the arguments used to prove the existence of god from motion is given by MICHAEL BUCKLEY, *Motion and Motion's God*, Princeton University Press, 1971. The intensity of the battles waged around these failed attempts is one of the tragicomic chapters of history. Cited on page 20.



- 13 THOMAS AQUINAS, *Summa Theologiae* or *Summa Theologica*, 1265–1273, online in Latin at [www.newadvent.org/summa](http://www.newadvent.org/summa), in English on several other servers. Cited on page 20.
- 14 For an exploration of ‘inner’ motions, see the beautiful text by RICHARD SCHWARTZ, *Internal Family Systems Therapy*, The Guilford Press, 1995. Cited on page 20.
- 15 For an authoritative description of proper motion development in babies and about how it leads to a healthy character see EMMI PIKLER, *Laßt mir Zeit - Die selbstständige Bewegungsentwicklung des Kindes bis zum freien Gehen*, Pflaum Verlag, 2001, and her other books. See also the website [www.pikler.org](http://www.pikler.org). Cited on page 20.
- 16 See e.g. the fascinating text by DAVID G. CHANDLER, *The Campaigns of Napoleon – The Mind and Method of History’s Greatest Soldier*, Macmillan, 1966. Cited on page 20.
- 17 RICHARD MARCUS, *American Roulette*, St Martin’s Press, 2003, a thriller and a true story. Cited on page 20.
- 18 A good and funny book on behaviour change is the well-known text by R. BANDLER, *Using Your Brain for a Change*, Real People Press, 1985. See also RICHARD BANDLER & JOHN GRINDER, *Frogs into princes – Neuro Linguistic Programming*, Eden Grove Editions, 1990. Cited on pages 20 and 30.
- 19 A beautiful book about the mechanisms of human growth from the original cell to full size is LEWIS WOLPERT, *The Triumph of the Embryo*, Oxford University Press, 1991. Cited on page 20.
- 20 On the topic of grace and poise, see e.g. the numerous books on the Alexander technique, such as M. GELB, *Body Learning – An Introduction to the Alexander Technique*, Aurum Press, 1981, and RICHARD BRENNAN, *Introduction to the Alexander Technique*, Little Brown and Company, 1996. Among others, the idea of the Alexander technique is to return to the situation that the muscle groups for sustainment and those for motion are used only for their respective function, and not vice versa. Any unnecessary muscle tension, such as neck stiffness, is a waste of energy due to the use of sustainment muscles for movement and of motion muscles for sustainment. The technique teaches the way to return to the natural use of muscles.
- Motion of animals was discussed extensively already in the seventeenth century by G. BORELLI, *De motu animalium*, 1680. An example of a more modern approach is J. J. COLLINS & I. STEWART, Hexapodal gaits and coupled nonlinear oscillator models, *Biological Cybernetics* 68, pp. 287–298, 1993. See also I. STEWART & M. GOLUBITSKY, *Fearful Symmetry*, Blackwell, 1992. Cited on pages 21 and 106.
- 21 The results on the development of children mentioned here and in the following have been drawn mainly from the studies initiated by Jean Piaget; for more details on child development, see an upcoming chapter, on page 177. At [www.piaget.org](http://www.piaget.org) you can find the website maintained by the Jean Piaget Society. Cited on pages 23, 38, and 39.
- 22 The reptilian brain (eat? flee? ignore?), also called the R-complex, includes the brain stem, the cerebellum, the basal ganglia and the thalamus; the old mammalian (emotions) brain, also called the limbic system, contains the amygdala, the hypothalamus and the hippocampus; the human (and primate) (rational) brain, called the neocortex, consists of the famous grey matter. For images of the brain, see the atlas by JOHN NOLTE, *The Human Brain: An Introduction to its Functional Anatomy*, Mosby, fourth edition, 1999. Cited on page 24.
- 23 The lower left corner film can be reproduced on a computer after typing the following lines in the Mathematica software package: Cited on page 24.

« Graphics’Animation’  
Nxpixels=72; Nypixels=54; Nframes=Nxpixels 4/3;

```

Nxwind=Round[Nxpixels/4]; Nywind=Round[Nypixels/3];
front=Table[Round[Random[]],{y,1,Nypixels},{x,1,Nxpixels}];
back =Table[Round[Random[]],{y,1,Nypixels},{x,1,Nxpixels}];
frame=Table[front,{nf,1,Nframes}];
Do[ If[ x>n-Nxwind && x<n && y>Nywind && y<2Nywind,
      frame[[n,y,x]]=back[[y,x-n]] ],
    {x,1,Nxpixels}, {y,1,Nypixels}, {n,1,Nframes}];
film=Table[ListDensityPlot[frame[[nf]], Mesh-> False,
      Frame-> False, AspectRatio-> N[Nypixels/Nxpixels],
      DisplayFunction-> Identity], {nf,1,Nframes}]
ShowAnimation[film]

```

But our motion detection system is much more powerful than the example shown in the lower left corners. The following, different film makes the point.

```

« Graphics'Animation'
Nxpixels=72; Nypixels=54; Nframes=Nxpixels 4/3;
Nxwind=Round[Nxpixels/4]; Nywind=Round[Nypixels/3];
front=Table[Round[Random[]],{y,1,Nypixels},{x,1,Nxpixels}];
back =Table[Round[Random[]],{y,1,Nypixels},{x,1,Nxpixels}];
frame=Table[front,{nf,1,Nframes}];
Do[ If[ x>n-Nxwind && x<n && y>Nywind && y<2Nywind,
      frame[[n,y,x]]=back[[y,x]] ],
    {x,1,Nxpixels}, {y,1,Nypixels}, {n,1,Nframes}];
film=Table[ListDensityPlot[frame[[nf]], Mesh-> False,
      Frame-> False, AspectRatio-> N[Nypixels/Nxpixels],
      DisplayFunction-> Identity], {nf,1,Nframes}]
ShowAnimation[film]

```

Similar experiments, e.g. using randomly changing random patterns, show that the eye perceives motion even in cases where all Fourier components of the image are practically zero; such image motion is called *drift-balanced* or *non-Fourier* motion. Several examples are presented in J. ZANKER, Modelling human motion perception I: Classical stimuli, *Naturwissenschaften* 81, pp. 156–163, 1994, and J. ZANKER, Modelling human motion perception II: Beyond Fourier motion stimuli, *Naturwissenschaften* 81, pp. 200–209, 1994.

- 24 All fragments from Heraclitus are from JOHN MANSLEY ROBINSON, *An Introduction to Early Greek Philosophy*, Houghton Muffin 1968, chapter 5. Cited on page 25.
- 25 An introduction to Newton the alchemist are the two books by BETTY JO TEETER DOBBS, *The Foundations of Newton's Alchemy*, Cambridge University Press, 1983, and *The Janus Face of Genius*, Cambridge University Press, 1992. Newton is found to be a sort of highly intellectual magician, desperately looking for examples of processes where gods interact with the material world. An intense but tragic tale. A good overview is provided by R. G. KEESING, Essay Review: Newton's Alchemy, *Contemporary Physics* 36, pp. 117–119, 1995.  
Newton's infantile theology, typical for god seekers who grew up without a father, can be found in the many books summarizing the letter exchanges between Clarke, his secretary, and Leibniz, Newton's rival for fame. Cited on page 32.
- 26 An introduction to the story of classical mechanics, which also destroys a few of the myths surrounding it – such as the idea that Newton could solve differential equations or that he introduced the expression  $F = ma$  – is given by CLIFFORD A. TRUESDELL, *Essays in the History of Mechanics*, Springer, 1968. Cited on pages 32, 154, and 183.

- 27 C. LIU, Z. DUTTON, C. H. BEHROOZI & L. VESTERGAARD HAU, Observation of coherent optical information storage in an atomic medium using halted light pulses, *Nature* 409, pp. 490–493, 2001. There is also a comment on the paper by E. A. CORNELL, Stopping light in its track, 409, pp. 461–462, 2001. However, despite the claim, the light pulses of course have *not* been halted. Can you give at least two reasons without even reading the paper, and maybe a third after reading it?
- Challenge 648 s
- The work was an improvement on the previous experiment where a group velocity of light of 17 m/s had been achieved, in an ultracold gas of sodium atoms, at nanokelvin temperatures. This was reported by L. VESTERGAARD HAU, S. E. HARRIS, Z. DUTTON & C. H. BEHROOZI, Light speed reduction to 17 meters per second in an ultracold atomic gas, *Nature* 397, pp. 594–598, 1999. Cited on page 34.
- 28 RAINER FLINDT, *Biologie in Zahlen – Eine Datensammlung in Tabellen mit über 10.000 Einzelwerten*, Spektrum Akademischer Verlag, 2000. Cited on page 34.
- 29 Two jets with that speed have been observed by I. F. MIRABEL & L. F. RODRÍGUEZ, A superluminal source in the Galaxy, *Nature* 371, pp. 46–48, 1994, as well as the comments on p. 18. Cited on page 34.
- 30 A beautiful introduction to the slowest motions in nature, the changes in landscapes, is DETLEV BUSCHE, JÜRGEN KEMPF & INGRID STENGEL, *Landschaftsformen der Erde – Bildatlas der Geomorphologie*, Primus Verlag, 2005. Cited on page 35.
- 31 To build your own sundial, see the pretty and short ARNOLD ZENKERT, *Faszination Sonnenuhr*, VEB Verlag Technik, 1984. See also the excellent and complete introduction into this somewhat strange world at the [www.sundials.co.uk](http://www.sundials.co.uk) website. Cited on page 40.
- 32 An introduction to the sense of time as a result of clocks in the brain is found in R. B. IVRY & R. SPENCER, The neural representation of time, *Current Opinion in Neurobiology* 14, pp. 225–232, 2004. The chemical clocks in our body are described in JOHN D. PALMER, *The Living Clock*, Oxford University Press, 2002, or in A. AHLGREN & F. HALBERG, *Cycles of Nature: An Introduction to Biological Rhythms*, National Science Teachers Association, 1990. See also the [www.msi.umn.edu/~halberg/introd](http://www.msi.umn.edu/~halberg/introd) website. Cited on page 40.
- 33 This has been shown among others by the work of Anna Wierzbicka that is discussed in more detail in one of the subsequent volumes. The passionate best seller by the Chomskian author STEVEN PINKER, *The Language Instinct – How the Mind Creates Language*, Harper Perennial, 1994, also discusses issues related to this matter, refuting amongst others on page 63 the often repeated false statement that the *Hopi* language is an exception. Cited on page 41.
- Vol. III, page 191
- 34 For more information, see the excellent and freely downloadable books on biological clocks by Wolfgang Engelmann on the website [www.uni-tuebingen.de/plantphys/bioclox](http://www.uni-tuebingen.de/plantphys/bioclox). Cited on page 41.
- 35 B. GÜNTHER & E. MORGADO, Allometric scaling of biological rhythms in mammals, *Biological Research* 38, pp. 207–212, 2005. Cited on page 43.
- 36 Aristotle rejects the idea of the flow of time in chapter IV of his *Physics*. See the full text on the [classics.mit.edu/Aristotle/physics.4.iv.html](http://classics.mit.edu/Aristotle/physics.4.iv.html) website. Cited on page 45.
- 37 Perhaps the most informative of the books about the ‘arrow of time’ is HANS DIETER ZEH, *The Physical Basis of the Direction of Time*, Springer Verlag, 4th edition, 2001. It is still the best book on the topic. Most other texts exist – have a look on the internet – but lack clarity of ideas.
- A typical conference proceeding is J. J. HALLIWELL, J. PÉREZ-MERCADER & WOJCIECH H. ZUREK, *Physical Origins of Time Asymmetry*, Cambridge University Press, 1994. Cited on page 45.

- 38 On the issue of absolute and relative motion there are many books about few issues. Examples are JULIAN BARBOUR, *Absolute or Relative Motion? Vol. 1: A Study from the Machian Point of View of the Discovery and the Structure of Spacetime Theories*, Cambridge University Press, 1989, JULIAN BARBOUR, *Absolute or Relative Motion? Vol. 2: The Deep Structure of General Relativity*, Oxford University Press, 2005, or JOHN EARMAN, *World Enough and Spacetime: Absolute vs Relational Theories of Spacetime*, MIT Press, 1989. Cited on page 49.
- 39 Coastlines and other fractals are beautifully presented in HEINZ-OTTO PEITGEN, HARTMUT JÜRGENS & DIETMAR SAUPE, *Fractals for the Classroom*, Springer Verlag, 1992, pp. 232–245. It is also available in several other languages. Cited on page 51.
- 40 R. DOUGHERTY & M. FOREMAN, Banach–Tarski decompositions using sets with the property of Baire, *Journal of the American Mathematical Society* 7, pp. 75–124, 1994. See also ALAN L. T. PATERSON, *Amenability*, American Mathematical Society, 1998, and ROBERT M. FRENCH, The Banach–Tarski theorem, *The Mathematical Intelligencer* 10, pp. 21–28, 1998. Finally, there are the books by BERNARD R. GELBAUM & JOHN M. H. OLMSTED, *counter-examples in Analysis*, Holden–Day, 1964, and their *Theorems and counter-examples in Mathematics*, Springer, 1993. Cited on page 53.
- 41 The beautiful but not easy text is STAN WAGON, *The Banach Tarski Paradox*, Cambridge University Press, 1993. Cited on pages 54 and 369.
- 42 About the shapes of salt water bacteria, see the corresponding section in the interesting book by BERNARD DIXON, *Power Unseen – How Microbes Rule the World*, W.H. Freeman, 1994. The book has about 80 sections, in which as many microorganisms are vividly presented. Cited on page 54.
- 43 OLAF MEDENBACH & HARRY WILK, *Zauberwelt der Mineralien*, Sigloch Edition, 1977. It combines beautiful photographs with an introduction into the science of crystals, minerals and stones. About the largest crystals, see P. C. RICKWOOD, The largest crystals, 66, pp. 885–908, 1981, also available on [www.minsocam.org/MSA/collectors\\_corner/arc/large\\_crystals.htm](http://www.minsocam.org/MSA/collectors_corner/arc/large_crystals.htm). For an impressive example, the Naica cave in Mexico, see [www.naica.com.mx/ingles/index.htm](http://www.naica.com.mx/ingles/index.htm) Cited on page 54.
- 44 See the websites [www.weltbildfrage.de/3frame.htm](http://www.weltbildfrage.de/3frame.htm) and [www.lhup.edu/~dsimanek/hollow/morrow.htm](http://www.lhup.edu/~dsimanek/hollow/morrow.htm). Cited on page 55.
- 45 The smallest distances are probed in particle accelerators; the distance can be determined from the energy of the particle beam. In 1996, the value of  $10^{-19}$  m (for the upper limit of the size of quarks) was taken from the experiments described in F. ABE & al., Measurement of dijet angular distributions by the collider detector at Fermilab, *Physical Review Letters* 77, pp. 5336–5341, 1996. Cited on page 60.
- 46 These puzzles are taken from the puzzle collection at [www.mathematische-basteleien.de](http://www.mathematische-basteleien.de). Cited on page 65.
- 47 ALEXANDER K. DEWDNEY, *The Planiverse – Computer Contact with a Two-dimensional World*, Poseidon Books/Simon & Schuster, 1984. See also EDWIN A. ABBOTT, *Flatland: A romance of many dimensions*, 1884. Several other fiction authors had explored the option of a two-dimensional universe before, always answering, incorrectly, in the affirmative. Cited on page 66.
- 48 P. PIERANSKI, S. PRZYBYL & A. STASIAK, Tight open knots, *European Physical Journal E* 6, pp. 123–128, 2001, preprint at [arxiv.org/abs/physics/0103016](http://arxiv.org/abs/physics/0103016). Cited on page 66.
- 49 On the world of fireworks, see the frequently asked questions list of the usenet group rec.pyrotechnics, or search the web. A simple introduction is the article by

- J. A. CONKLING, Pyrotechnics, *Scientific American* pp. 66–73, July 1990. Cited on page 68.
- 50 There is a whole story behind the variations of  $g$ . It can be discovered in CHUJI TSUBOI, *Gravity*, Allen & Unwin, 1979, or in WOLFGANG TORGE, *Gravimetry*, de Gruyter, 1989, or in MILAN BURŠA & KAREL PĚČ, *The Gravity Field and the Dynamics of the Earth*, Springer, 1993. The variation of the height of the soil by up to 0.3 m due to the Moon is one of the interesting effects found by these investigations. Cited on pages 69 and 161.
- 51 STILLMAN DRAKE, *Galileo: A Very Short Introduction*, Oxford University Press, 2001. Cited on page 69.
- 52 ANDREA FROVA, *La fisica sotto il naso – 44 pezzi facili*, Biblioteca Universale Rizzoli, Milano, 2001. Cited on page 69.
- 53 On the other hands, other sciences enjoy studying usual paths in all detail. See, for example, HEINI HEDIGER, editor, *Die Straßen der Tiere*, Vieweg & Sohn, 1967. Cited on page 70.
- 54 H. K. ERIKSEN, J. R. KRISTIANSEN, Ø. LANGANGEN & I. K. WEHUS, How fast could Usain Bolt have run? A dynamical study, *American Journal of Physics* 77, pp. 224–228, 2009. Cited on page 71.
- 55 This was discussed in the *Frankfurter Allgemeine Zeitung*, 2nd of August, 1997, at the time of the world athletics championship. The values are for the fastest part of the race of a 100 m sprinter; the exact values cited were called the running speed world records in 1997, and were given as  $12.048 \text{ m/s} = 43.372 \text{ km/h}$  by Ben Johnson for men, and  $10.99 \text{ m/s} = 39.56 \text{ km/h}$  for women. Cited on page 71.
- 56 Long jump data and literature can be found in three articles all entitled Is a good long jumper a good high jumper?, in the *American Journal of Physics* 69, pp. 104–105, 2001. In particular, world class long jumpers run at  $9.35 \pm 0.15 \text{ m/s}$ , with vertical take-off speeds of  $3.35 \pm 0.15 \text{ m/s}$ , giving take-off angles of about (only)  $20^\circ$ . A new technique for achieving higher take-off angles would allow the world long jump record to increase dramatically. Cited on page 71.
- 57 The study of shooting faeces (i.e., shit) and its mechanisms is a part of modern biology. The reason that caterpillars do this was determined by M. WEISS, Good housekeeping: why do shelter-dwelling caterpillars fling their frass?, *Ecology Letters* 6, pp. 361–370, 2003, who also gives the present record of 1.5 m for the 24 mg pellets of *Epargyreus clarus*. The picture of the flying frass is from S. CAVENEY, H. MCLEAN & D. SURRY, Faecal firing in a skipper caterpillar is pressure-driven, *The Journal of Experimental Biology* 201, pp. 121–133, 1998. Cited on page 71.
- 58 H. C. BENNET-CLARK, Scale effects in jumping animals, pp. 185–201, in T. J. PEDLEY, editor, *Scale Effects in Animal Locomotion*, Academic Press, 1977. Cited on page 73.
- 59 The arguments of Zeno can be found in ARISTOTLE, *Physics*, VI, 9. It can be found translated in almost any language. The [classics.mit.edu/Aristotle/physics.6.vi.html](http://classics.mit.edu/Aristotle/physics.6.vi.html) website provides an online version in English. Cited on pages 76 and 405.
- 60 See, for exaple, K. V. KUMAR & W. T. NORFLEET, Issues of human acceleration tolerance after long-duration space flights, *NASA Technical Memorandum* 104753, pp. 1–55, 1992, available at [ntrs.nasa.gov](http://ntrs.nasa.gov). Cited on page 76.
- 61 Etymology can be a fascinating topic, e.g. when research discovers the origin of the German word ‘Weib’ (‘woman’, related to English ‘wife’). It was discovered, via a few texts in Tocharian – an extinct Indo-European language from a region inside modern China – to mean originally ‘shame’. It was used for the female genital region in an expression meaning ‘place of shame’. With time, this expression became to mean ‘woman’ in general, while being



shortened to the second term only. This connection was discovered by the German linguist Klaus T. Schmidt; it explains in particular why the word is not feminine but neutral, i.e., why it uses the article 'das' instead of 'die'. Julia Simon, private communication.

Etymology can also be simple and plain fun, for example when one discovers in the *Oxford English Dictionary* that 'testimony' and 'testicle' have the same origin; indeed in Latin the same word 'testis' was used for both concepts. Cited on pages 79 and 89.

- 62 An overview of the latest developments is given by J. T. ARMSTRONG, D. J. HUNTER, K. J. JOHNSTON & D. MOZURKEWICH, Stellar optical interferometry in the 1990s, *Physics Today* pp. 42–49, May 1995. More than 100 stellar diameters were known already in 1995. Several dedicated powerful instruments are being planned. Cited on page 80.
- 63 A good biology textbook on growth is ARTHUR F. HOPPER & NATHAN H. HART, *Foundations of Animal Development*, Oxford University Press, 2006. Cited on page 80.
- 64 This is discussed for example in C. L. STONG, The amateur scientist – how to supply electric power to something which is turning, *Scientific American* pp. 120–125, December 1975. It also discusses how to make a still picture of something rotating simply by using a few prisms, the so-called *Dove prisms*. Other examples of attaching something to a rotating body are given by E. RIEFLIN, Some mechanisms related to Dirac's strings, *American Journal of Physics* 47, pp. 379–381, 1979. Cited on page 81.
- 65 JAMES A. YOUNG, Tumbleweed, *Scientific American* 264, pp. 82–87, March 1991. The tumbleweed is in fact quite rare, except in Hollywood westerns, where all directors feel obliged to give it a special appearance. Cited on page 81.
- 66 About *N. decemspinosa*, see R. L. CALDWELL, A unique form of locomotion in a stomatopod – backward somersaulting, *Nature* 282, pp. 71–73, 1979, and R. FULL, K. EARLS, M. WONG & R. CALDWELL, Locomotion like a wheel?, *Nature* 365, p. 495, 1993. About rolling caterpillars, see J. BRACKENBURY, Caterpillar kinematics, *Nature* 330, p. 453, 1997, and J. BRACKENBURY, Fast locomotion in caterpillars, *Journal of Insect Physiology* 45, pp. 525–533, 1999. More images around legs can be found on [rjf9.biol.berkeley.edu/twiki/bin/view/PolyPEDAL/LabPhotographs](http://rjf9.biol.berkeley.edu/twiki/bin/view/PolyPEDAL/LabPhotographs). Cited on page 81.
- 67 This spider, of the genus *Cerebrennus*, has been described by Ingo Rechenberg from Berlin. Cited on page 81.
- 68 The first experiments to prove the rotation of the flagella were by M. SILVERMAN & M. I. SIMON, Flagellar rotation and the mechanism of bacterial motility, *Nature* 249, pp. 73–74, 1974. For some pretty pictures of the molecules involved, see K. NAMBA, A biological molecular machine: bacterial flagellar motor and filament, *Wear* 168, pp. 189–193, 1993, or the website [www.nanonet.go.jp/english/mailmag/2004/011a.html](http://www.nanonet.go.jp/english/mailmag/2004/011a.html). The present record speed of rotation, 1700 rotations per second, is reported by Y. MAGARIYAMA, S. SUGIYAMA, K. MURAMOTO, Y. MAEKAWA, I. KAWAGISHI, Y. IMAE & S. KUDO, Very fast flagellar rotation, *Nature* 371, p. 752, 1994.
- More on bacteria can be learned from DAVID DUSENBERY, *Life at a Small Scale*, Scientific American Library, 1996. Cited on page 82.
- 69 M. P. BRENNER, S. HILGENFELDT & D. LOHSE, Single bubble sonoluminescence, *Reviews of Modern Physics* 74, pp. 425–484, 2002. Cited on page 84.
- 70 K. R. WENINGER, B. P. BARBER & S. J. PUTTERMAN, Pulsed Mie scattering measurements of the collapse of a sonoluminescing bubble, *Physical Review Letters* 78, pp. 1799–1802, 1997. Cited on page 84.
- 71 On shadows, see the agreeable popular text by ROBERTO CASATI, *Alla scoperta dell'ombra – Da Platone a Galileo la storia di un enigma che ha affascinato le grandi menti dell'umanità*,

- Oscar Mondadori, 2000, and his websites located at [www.shadowmill.com](http://www.shadowmill.com) and [roberto.casati.free.fr/casati/roberto.htm](http://roberto.casati.free.fr/casati/roberto.htm). Cited on page 86.
- 72** There is also the beautiful book by PENELOPE FARRANT, *Colour in Nature*, Blandford, 1997. Cited on page 86.
- 73** The ‘laws’ of cartoon physics can easily be found using any search engine on the internet. Cited on page 86.
- 74** For the curious, an overview of the illusions used in the cinema and in television, which lead to some of the strange behaviour of images mentioned above, is given in BERNARD WILKIE, *The Technique of Special Effects in Television*, Focal Press, 1993, and his other books, or in the *Cinefex* magazine. On digital cinema techniques, see PETER C. SLANSKY, editor, *Digitaler film – digitale Kino*, UVK Verlag, 2004. Cited on page 87.
- 75** AETIUS, Opinions, I, XXIII, 3. See JEAN-PAUL DUMONT, *Les écoles présocratiques*, Folio Essais, Gallimard, p. 426, 1991. Cited on page 87.
- 76** GIUSEPPE FUMAGALLI, *Chi l’ha detto?*, Hoepli, 1983. Cited on pages 88 and 190.
- 77** See [www.straightdope.com/classics/a5\\_262.html](http://www.straightdope.com/classics/a5_262.html) and the more dubious [en.wikipedia.org/wiki/Guillotine](http://en.wikipedia.org/wiki/Guillotine). Cited on page 89.
- 78** For the role and chemistry of adenosine triphosphate (ATP) in cells and in living beings, see any chemistry book, or search the internet. The uncovering of the mechanisms around ATP has led to Nobel Prizes in Chemistry in 1978 and in 1997. Cited on page 96.
- 79** A picture of this unique clock can be found in the article by A. GARRETT, Perpetual motion – a delicious delirium, *Physics World* pp. 23–26, December 1990. Cited on page 96.
- 80** A Shell study estimated the world’s total energy consumption in 2000 to be 500 EJ. The US Department of Energy estimated it to be around 416 EJ. We took the lower value here. A discussion and a breakdown into electricity usage (14 EJ) and other energy forms, with variations per country, can be found in S. BENKA, The energy challenge, *Physics Today* 55, pp. 38–39, April 2002, and in E. J. MONITZ & M. A. KENDERDINE, Meeting energy challenges: technology and policy, *Physics Today* 55, pp. 40–46, April 2002. Cited on pages 99 and 100.
- 81** For an overview, see the paper by J. F. MULLIGAN & H. G. HERTZ, An unpublished lecture by Heinrich Hertz: ‘On the energy balance of the Earth’, *American Journal of Physics* 65, pp. 36–45, 1997. Cited on page 100.
- 82** For a beautiful photograph of this feline feat, see the cover of the journal and the article of J. DARIUS, A tale of a falling cat, *Nature* 308, p. 109, 1984. Cited on page 105.
- 83** NATTHI L. SHARMA, A new observation about rolling motion, *European Journal of Physics* 17, pp. 353–356, 1996. Cited on page 105.
- 84** C. SINGH, When physical intuition fails, *American Journal of Physics* 70, pp. 1103–1109, 2002. Cited on page 106.
- 85** SERGE GRACOVETSKY, *The Spinal Engine*, Springer Verlag, 1990. It is now also known that human gait is chaotic. This is explained by M. PERC, The dynamics of human gait, *European Journal of Physics* 26, pp. 525–534, 2005. Cited on page 106.
- 86** M. LLOBERA & T. J. SLUCKIN, Zigzagging: theoretical insights on climbing strategies, *Journal of Theoretical Biology* 249, pp. 206–217, 2007. Cited on page 107.
- 87** DUNCAN MACDOUGALL, Hypothesis concerning soul substance together with experimental evidence of the existence of such substance, *American Medicine* 2, pp. 240–243,



- April 1907, and DUNCAN MACDOUGALL, Hypothesis concerning soul substance, *American Medicine* 2, pp. 395–397, July 1907. Reading the papers shows that the author has little practice in performing reliable weight and time measurements. Cited on page 108.
- 88 A good roulette prediction story from the 1970s is told by THOMAS A. BASS, *The Eu-daemonic Pie* also published under the title *The Newtonian Casino*, Backinprint, 2000. An overview up to 1998 is given in the paper EDWARD O. THORP, The invention of the first wearable computer, *Proceedings of the Second International Symposium on Wearable Computers* (ISWC 1998), 19–20 October 1998, Pittsburgh, Pennsylvania, USA (IEEE Computer Society), pp. 4–8, 1998, downloadable at [csdl.computer.org/comp/proceedings/iswc/1998/9074/00/9074toc.htm](http://csdl.computer.org/comp/proceedings/iswc/1998/9074/00/9074toc.htm). Cited on page 108.
- 89 This and many other physics surprises are described in the beautiful lecture script by JOSEF ZWECK, *Physik im Alltag*, the notes of his lectures held in 1999/2000 at the Universität Regensburg. Cited on pages 109 and 134.
- 90 The equilibrium of ships, so important in car ferries, is an interesting part of shipbuilding; an introduction was already given by LEONHARD EULER, *Scientia navalis*, 1749. Cited on page 110.
- 91 THOMAS HEATH, *Aristarchus of Samos – the Ancient Copernicus*, Dover, 1981, reprinted from the original 1913 edition. Aristarchos' treaty is given in Greek and English. Aristarchos was the first proposer of the heliocentric system. Aristarchus had measured the length of the day (in fact, by determining the number of days per year) to the astonishing precision of less than one second. This excellent book also gives an overview of Greek astronomy before Aristarchus, explained in detail for each Greek thinker. Aristarchus' text is also reprinted in ARISTARCHUS, *On the sizes and the distances of the Sun and the Moon, c. 280 BCE* in MICHAEL J. CROWE, *Theories of the World From Antiquity to the Copernican Revolution*, Dover, 1990, especially on pp. 27–29. Cited on page 114.
- 92 See for example the videos on the Coriolis effect at [techtv.mit.edu/videos/3722](http://techtv.mit.edu/videos/3722) and [techtv.mit.edu/videos/3714](http://techtv.mit.edu/videos/3714), or search for videos on [youtube.com](http://youtube.com). Cited on page 116.
- 93 The influence of the Coriolis effect on icebergs was studied most thoroughly by the Swedish physicist turned oceanographer Walfrid Ekman (1874–1954); the topic was suggested by the great explorer Fridtjof Nansen, who also made the first observations. In his honour, one speaks of the Ekman layer, Ekman transport and Ekman spirals. Any text on oceanography or physical geography will give more details about them. Cited on page 116.
- 94 An overview of the effects of the Coriolis acceleration  $\mathbf{a} = -2\boldsymbol{\omega} \times \mathbf{v}$  in the rotating frame is given by EDWARD A. DESLOGE, *Classical Mechanics*, Volume 1, John Wiley & Sons, 1982. Even the so-called *Gulf Stream*, the current of warm water flowing from the Caribbean to the North Sea, is influenced by it. Cited on page 117.
- 95 The original publication is by A. H. SHAPIRO, Bath-tub vortex, *Nature* 196, pp. 1080–1081, 1962. He also produced two films of the experiment. The experiment has been repeated many times in the northern and in the southern hemisphere, where the water drains clockwise; the first southern hemisphere test was L.M. TREFETHEN & al., The bath-tub vortex in the southern hemisphere, *Nature* 201, pp. 1084–1085, 1965. A complete literature list is found in the letters to the editor of the *American Journal of Physics* 62, p. 1063, 1994. Cited on page 117.
- 96 The tricks are explained by RICHARD CRANE, Short Foucault pendulum: a way to eliminate the precession due to ellipticity, *American Journal of Physics* 49, pp. 1004–1006, 1981, and particularly in RICHARD CRANE, Foucault pendulum wall clock, *American Journal of Physics* 63, pp. 33–39, 1993. The Foucault pendulum was also the topic of the thesis of

- HEIKE KAMERLING ONNES, *Nieuwe bewijzen der aswenteling der aarde*, Universiteit Groningen, 1879. Cited on page 117.
- 97 The reference is J. G. HAGEN, *La rotation de la terre : ses preuves mécaniques anciennes et nouvelles*, *Sp. Astr. Vaticana Second. App.* Rome, 1910. His other experiment is published as J. G. HAGEN, How Atwood's machine shows the rotation of the Earth even quantitatively, International Congress of Mathematics, Aug. 1912. Cited on page 118.
- 98 The original papers are A. H. COMPTON, A laboratory method of demonstrating the Earth's rotation, *Science* 37, pp. 803–806, 1913, A. H. COMPTON, Watching the Earth revolve, *Scientific American Supplement* no. 2047, pp. 196–197, 1915, and A. H. COMPTON, A determination of latitude, azimuth and the length of the day independent of astronomical observations, *Physical Review* (second series) 5, pp. 109–117, 1915. Cited on page 118.
- 99 R. ANDERSON, H. R. BILGER & G. E. STEDMAN, The Sagnac-effect: a century of Earth-rotated interferometers, *American Journal of Physics* 62, pp. 975–985, 1994.  
See also the clear and extensive paper by G. E. STEDMAN, Ring laser tests of fundamental physics and geophysics, *Reports on Progress in Physics* 60, pp. 615–688, 1997. Cited on page 120.
- 100 About the length of the day, see the [maia.usno.navy.mil](http://maia.usno.navy.mil) website, or the books by K. LAMBECK, *The Earth's Variable Rotation: Geophysical Causes and Consequences*, Cambridge University Press, 1980, and by W. H. MUNK & G. J. F. MACDONALD, *The Rotation of the Earth*, Cambridge University Press, 1960. About a modern ring laser set-up, see [www.wettzell.ifag.de](http://www.wettzell.ifag.de). Cited on pages 120 and 163.
- 101 H. BUCKA, Zwei einfache Vorlesungsversuche zum Nachweis der Erddrehung, *Zeitschrift für Physik* 126, pp. 98–105, 1949, and H. BUCKA, Zwei einfache Vorlesungsversuche zum Nachweis der Erddrehung. II. Teil, *Zeitschrift für Physik* 128, pp. 104–107, 1950. Cited on page 121.
- 102 One example of data is by C. P. SONETT, E. P. KVALE, A. ZAKHARIAN, M. A. CHAN & T. M. DEMKO, Late proterozoic and paleozoic tides, retreat of the moon, and rotation of the Earth, *Science* 273, pp. 100–104, 5 July 1996. They deduce from tidal sediment analysis that days were only 18 to 19 hours long in the Proterozoic, i.e., 900 million years ago; they assume that the year was 31 million seconds long from then to today. See also C. P. SONETT & M. A. CHAN, Neoproterozoic Earth-Moon dynamics – rework of the 900 MA Big Cottonwood canyon tidal laminae, *Geophysical Research Letters* 25, pp. 539–542, 1998. Another determination was by G. E. WILLIAMS, Precambrian tidal and glacial clastic deposits: implications for precambrian Earth–Moon dynamics and palaeoclimate, *Sedimentary Geology* 120, pp. 55–74, 1998. Using a geological formation called *tidal rhythmites*, he deduced that about 600 million years ago there were 13 months per year and a day had 22 hours. Cited on page 121.
- 103 The story of this combination of history and astronomy is told in RICHARD STEPHENSON, *Historical Eclipses and Earth's Rotation*, Cambridge University Press, 1996. Cited on page 121.
- 104 B. F. CHAO, Earth Rotational Variations excited by geophysical fluids, IVS 2004 General Meeting proceedings/ pages 38–46. Cited on page 122.
- 105 On the rotation and history of the solar system, see S. BRUSH, Theories of the origin of the solar system 1956–1985, *Reviews of Modern Physics* 62, pp. 43–112, 1990. Cited on page 122.
- 106 The website [hpiers.obspm.fr/eop-pc](http://hpiers.obspm.fr/eop-pc) shows the motion of the Earth's axis over the last ten years. The International Latitude Service founded by Küstner is now part of the International Earth Rotation Service; more information can be found on the [www.iers.org](http://www.iers.org) website.

- The latest idea is that two-thirds of the circular component of the polar motion, which in the USA is called ‘Chandler wobble’ after the person who attributed to himself the discovery by Küstner, is due to fluctuations of the ocean pressure at the bottom of the oceans and one-third is due to pressure changes in the atmosphere of the Earth. This is explained by R. S. GROSS, The excitation of the Chandler wobble, *Geophysical Physics Letters* 27, pp. 2329–2332, 2000. Cited on page 124.
- 107** S. B. LAMBERT, C. BIZOUARD & V. DEHANT, Rapid variations in polar motion during the 2005–2006 winter season, *Geophysical Research Letters* 33, p. L13303, 2006. Cited on page 124.
- 108** For more information about Alfred Wegener, see the (simple) text by KLAUS ROHRBACH, *Alfred Wegener – Erforscher der wandernden Kontinente*, Verlag Freies Geistesleben, 1993; about plate tectonics, see the [www.scotese.com](http://www.scotese.com) website. About earthquakes, see the [www.geo.ed.ac.uk/quakexe/quakes](http://www.geo.ed.ac.uk/quakexe/quakes) and the [www.iris.edu/seismon](http://www.iris.edu/seismon) website. See the [vulcan.wr.usgs.gov](http://vulcan.wr.usgs.gov) and the [www.dartmouth.edu/~volcano](http://www.dartmouth.edu/~volcano) websites for information about volcanoes. Cited on page 125.
- 109** J. JOUZEL & al., Orbital and millennial Antarctic climate variability over the past 800,000 years, *Science* 317, pp. 793–796, 2007, takes the data from isotope concentrations in ice cores. In contrast, J. D. HAYS, J. IMBRIE & N. J. SHACKLETON, Variations in the Earth’s orbit: pacemaker of the ice ages, *Science* 194, pp. 1121–1132, 1976, confirmed the connection with orbital parameters by literally digging in the mud that covers the ocean floor in certain places. Note that the web is full of information on the ice ages. Just look up ‘Milankovitch’ in a search engine. Cited on pages 128 and 129.
- 110** R. HUMPHREYS & J. LARSEN, The sun’s distance above the galactic plane, *Astronomical Journal* 110, pp. 2183–2188, November 1995. Cited on page 128.
- 111** C. L. BENNET, M. S. TURNER & M. WHITE, The cosmic rosetta stone, *Physics Today* 50, pp. 32–38, November 1997. Cited on page 130.
- 112** On [www.sff.net/people/geoffrey.landis/vacuum.html](http://www.sff.net/people/geoffrey.landis/vacuum.html) you can read a description of what happened. See also the [www.sff.net/people/geoffrey.landis/ebullism.html](http://www.sff.net/people/geoffrey.landis/ebullism.html) and [imagine.gsfc.nasa.gov/docs/ask\\_astro/answers/970603.html](http://imagine.gsfc.nasa.gov/docs/ask_astro/answers/970603.html) websites. They all give details on the effects of vacuum on humans. Cited on page 132.
- 113** R. MCN. ALEXANDER, Leg design and jumping technique for humans, other vertebrates and insects, *Philosophical Transactions of the Royal Society in London B* 347, pp. 235–249, 1995. Cited on page 137.
- 114** J. W. GLASHEEN & T. A. MCMAHON, A hydrodynamic model of locomotion in the basilisk lizard, *Nature* 380, pp. 340–342, For pictures, see also *New Scientist*, p. 18, 30 March 1996, or *Scientific American*, pp. 48–49, September 1997, or the website by the author at [rjf2.biol.berkeley.edu/Full\\_Lab/FL\\_Personnel/J\\_Glasheen/J\\_Glasheen.html](http://rjf2.biol.berkeley.edu/Full_Lab/FL_Personnel/J_Glasheen/J_Glasheen.html).  
Several shore birds also have the ability to run over water, using the same mechanism. Cited on page 138.
- 115** A. FERNANDEZ-NIEVES & F. J. DE LAS NIEVES, About the propulsion system of a kayak and of *Basiliscus basiliscus*, *European Journal of Physics* 19, pp. 425–429, 1998. Cited on page 138.
- 116** Y. S. SONG, S. H. SUHR & M. SITTI, Modeling of the supporting legs for designing biomimetic water strider robot, Proceedings of the IEEE International Conference on Robotics and Automation, Orlando, USA, 2006. S. H. SUHR, Y. S. SONG, S. J. LEE & M. SITTI, Biologically inspired miniature water strider robot, Proceedings of the Robotics: Science and Systems I, Boston, USA, 2005. See also the website [www.me.cmu.edu/faculty1/sitti/nano/projects/waterstrider](http://www.me.cmu.edu/faculty1/sitti/nano/projects/waterstrider). Cited on page 139.

- 117** M. WITTLINGER, R. WEHNER & H. WOLF, The ant odometer: stepping on stilts and stumps, *Science* 312, pp. 1965–1967, 2006. Cited on page 139.
- 118** P. G. WEYAND, D. B. STERNLIGHT, M. J. BELLIZZI & S. WRIGHT, Faster top running speeds are achieved with greater ground forces not more rapid leg movements, *Journal of Applied Physiology* 89, pp. 1991–1999, 2000. Cited on page 139.
- 119** The material on the shadow discussion is from the book by ROBERT M. PRYCE, *Cook and Peary*, Stackpole Books, 1997. See also the details of Peary’s forgeries in WALLY HERBERT, *The Noose of Laurels*, Doubleday 1989. The sad story of Robert Peary is also told in the centenary number of *National Geographic*, September 1988. Since the National Geographic Society had financed Peary in his attempt and had supported him until the US Congress had declared him the first man at the Pole, the (partial) retraction is noteworthy. (The magazine then changed its mind again later on, to sell more copies, and now again claims that Peary reached the North Pole.) By the way, the photographs of Cook, who claimed to have been at the North Pole even before Peary, have the same problem with the shadow length. Both men have a history of cheating about their ‘exploits’. As a result, the first man at the North Pole was probably Roald Amundsen, who arrived there a few years later, and who was also the first man at the South Pole. Cited on page 141.
- 120** The story is told in M. NAUENBERG, Hooke, orbital motion, and Newton’s Principia, *American Journal of Physics* 62, 1994, pp. 331–350. Cited on page 142.
- 121** More details are given by D. RAWLINS, in Doubling your sunsets or how anyone can measure the Earth’s size with wristwatch and meter stick, *American Journal of Physics* 47, 1979, pp. 126–128. Another simple measurement of the Earth radius, using only a sextant, is given by R. O’KEEFE & B. GHAVIMI-ALAGHA, in The World Trade Centre and the distance to the world’s centre, *American Journal of Physics* 60, pp. 183–185, 1992. Cited on page 143.
- 122** More details on astronomical distance measurements can be found in the beautiful little book by A. VAN HELDEN, *Measuring the Universe*, University of Chicago Press, 1985, and in NIGEL HENBEST & HEATHER COOPER, *The Guide to the Galaxy*, Cambridge University Press, 1994. Cited on page 143.
- 123** A lot of details can be found in M. JAMMER, *Concepts of Mass in Classical and Modern Physics*, reprinted by Dover, 1997, and in *Concepts of Force, a Study in the Foundations of Mechanics*, Harvard University Press, 1957. These eclectic and thoroughly researched texts provide numerous details and explain various philosophical viewpoints, but lack clear statements and conclusions on the accurate description of nature; thus are not of help on fundamental issues.  
Jean Buridan (c. 1295 to c. 1366) criticizes the distinction of sublunar and translunar motion in his book *De Caelo*, one of his numerous works. Cited on page 143.
- 124** D. TOPPER & D. E. VINCENT, An analysis of Newton’s projectile diagram, *European Journal of Physics* 20, pp. 59–66, 1999. Cited on page 144.
- 125** The absurd story of the metre is told in the historical novel by KEN ALDER, *The Measure of All Things : The Seven-Year Odyssey and Hidden Error that Transformed the World*, The Free Press, 2003. Cited on page 146.
- 126** About the measurement of spatial dimensions via gravity – and the failure to find any hint for a number different from three – see the review by E. G. ADELBERGER, B. R. HECKEL & A. E. NELSON, Tests of the gravitational inverse-square law, *Annual Review of Nuclear and Particle Science* 53, pp. 77–121, 2003, also [arxiv.org/abs/hep-ph/0307284](https://arxiv.org/abs/hep-ph/0307284), or the review by J. A. HEWETT & M. SPIROPULU, Particle physics probes of extra spacetime dimensions, *Annual Review of Nuclear and Particle Science* 52, pp. 397–424, 2002, [arxiv.org/abs/hep-ph/0205106](https://arxiv.org/abs/hep-ph/0205106). Cited on page 151.

- 127** There are many books explaining the origin of the precise shape of the Earth, such as the pocket book S. ANDERS, *Weil die Erde rotiert*, Verlag Harri Deutsch, 1985. Cited on page [151](#).
- 128** The shape of the Earth is described most precisely with the World Geodetic System. For an extensive presentation, see the [www.eurocontrol.be/projects/eatchip/wgs84/start.html](http://www.eurocontrol.be/projects/eatchip/wgs84/start.html) website. See also the website of the *International Earth Rotation Service* at [hpiers.obspm.fr](http://hpiers.obspm.fr). Cited on page [151](#).
- 129** G. HECKMAN & M. VAN HAANDEL, De vele bewijzen van Kepler's wet over ellipsenbanen: een nieuwe voor 'het Boek?', *Nederlands Tijdschrift voor Natuurkunde* 73, pp. 366–368, November 2007. Cited on page [153](#).
- 130** W. K. HARTMAN, R. J. PHILLIPS & G. J. TAYLOR, editors, *Origin of the Moon*, Lunar and Planetary Institute, 1986. Cited on page [156](#).
- 131** If you want to read about the motion of the Moon in all its fascinating details, have a look at MARTIN C. GUTZWILLER, Moon–Earth–Sun: the oldest three body problem, *Reviews of Modern Physics* 70, pp. 589–639, 1998. Cited on page [156](#).
- 132** DIETRICH NEUMANN, Physiologische Uhren von Insekten – Zur Ökophysiologie lunarperiodisch kontrollierter Fortpflanzungszeiten, *Naturwissenschaften* 82, pp. 310–320, 1995. Cited on page [156](#).
- 133** The origin of the duration of the menstrual cycle is not yet settled; however, there are explanations on how it becomes synchronized with other cycles. For a general explanation see ARKADY PIKOVSKY, MICHAEL ROSENBLUM & JÜRGEN KURTHS, *Synchronization: A Universal Concept in Nonlinear Science*, Cambridge University Press, 2002. Cited on page [157](#).
- 134** J. LASKKAR, F. JOUTEL & P. ROBUTEL, Stability of the Earth's obliquity by the moon, *Nature* 361, pp. 615–617, 1993. However, the question is not completely settled, and other opinions exist. Cited on page [157](#).
- 135** NEIL F. COMINS, *What if the Moon Did not Exist? – Voyages to Earths that Might Have Been*, Harper Collins, 1993. Cited on page [157](#).
- 136** PAUL A. WIEGERT, KIMMO A. INNANEN & SEPPO MIKKOLA, An asteroidal companion to the Earth, *Nature* 387, pp. 685–686, 12 June 1997, together with the comment on pp. 651–652. Details on the orbit and on the fact that Lagrangian points do not always form equilateral triangles can be found in F. NAMOUNI, A. A. CHRISTOU & C. D. MURRAY, Coorbital dynamics at large eccentricity and inclination, *Physical Review Letters* 83, pp. 2506–2509, 1999. Cited on page [159](#).
- 137** SIMON NEWCOMB, *Astronomical Papers of the American Ephemeris* 1, p. 472, 1882. Cited on page [160](#).
- 138** For an animation of the tides, have a look at [www.jason.oceanobs.com/html/applications/marees/m2\\_atlantique\\_fr.html](http://www.jason.oceanobs.com/html/applications/marees/m2_atlantique_fr.html). Cited on page [160](#).
- 139** A beautiful introduction is the classic G. FALK & W. RUPPEL, *Mechanik, Relativität, Gravitation – ein Lehrbuch*, Springer Verlag, Dritte Auflage, 1983. Cited on page [161](#).
- 140** J. SOLDNER, *Berliner Astronomisches Jahrbuch auf das Jahr 1804*, 1801, p. 161. Cited on page [164](#).
- 141** The equality was first tested with precision by R. VON EÖTVÖS, *Annalen der Physik & Chemie* 59, p. 354, 1896, and by R. VON EÖTVÖS, V. PEKÁR, E. FEKETE, Beiträge zum Gesetz der Proportionalität von Trägheit und Gravität, *Annalen der Physik* 4, Leipzig 68, pp. 11–66, 1922. He found agreement to 5 parts in  $10^9$ . More experiments were performed



- by P. G. ROLL, R. KROTKOW & R. H. DICKE, The equivalence of inertial and passive gravitational mass, *Annals of Physics (NY)* 26, pp. 442–517, 1964, one of the most interesting and entertaining research articles in experimental physics, and by V. B. BRAGINSKY & V. I. PANOV, *Soviet Physics – JETP* 34, pp. 463–466, 1971. Modern results, with errors less than one part in  $10^{12}$ , are by Y. SU & al., New tests of the universality of free fall, *Physical Review D* 50, pp. 3614–3636, 1994. Several experiments have been proposed to test the equality in space to less than one part in  $10^{16}$ . Cited on page 165.
- 142** H. EDELMANN, R. NAPIWOTZKI, U. HEBER, N. CHRISTLIEB & D. REIMERS, HE 0437-5439: an unbound hyper-velocity B-type star, *The Astrophysical Journal* 634, pp. L181–L184, 2005. Cited on page 170.
- 143** This is explained for example by D.K. FIRPIĆ & I.V. ANIÇIN, The planets, after all, may run only in perfect circles – but in the velocity space!, *European Journal of Physics* 14, pp. 255–258, 1993. Cited on pages 170 and 390.
- 144** See L. HODGES, Gravitational field strength inside the Earth, *American Journal of Physics* 59, pp. 954–956, 1991. Cited on page 171.
- 145** P. MOHAZZABI & M. C. JAMES, Plumb line and the shape of the Earth, *American Journal of Physics* 68, pp. 1038–1041, 2000. Cited on page 172.
- 146** From NEIL DE GASSE TYSON, *The Universe Down to Earth*, Columbia University Press, 1994. Cited on page 173.
- 147** G. D. QUINLAN, Planet X: a myth exposed, *Nature* 363, pp. 18–19, 1993. Cited on page 173.
- 148** See [en.wikipedia.org/wiki/90377\\_Sedna](http://en.wikipedia.org/wiki/90377_Sedna). Cited on page 173.
- 149** See R. MATTHEWS, Not a snowball's chance ..., *New Scientist* 12 July 1997, pp. 24–27. The original claim is by LOUIS A. FRANK, J. B. SIGWARTH & J. D. CRAVEN, On the influx of small comets into the Earth's upper atmosphere, parts I and II, *Geophysical Research Letters* 13, pp. 303–306, pp. 307–310, 1986. The latest observations have disproved the claim. Cited on page 173.
- 150** The ray form is beautifully explained by J. EVANS, The ray form of Newton's law of motion, *American Journal of Physics* 61, pp. 347–350, 1993. Cited on page 175.
- 151** This is a small example from the beautiful text by MARK P. SILVERMAN, *And Yet It Moves: Strange Systems and Subtle Questions in Physics*, Cambridge University Press, 1993. It is a treasure chest for anybody interested in the details of physics. Cited on page 175.
- 152** G. -L. LESAGE, Lucrèce Newtonien, *Nouveaux mémoires de l'Académie Royale des Sciences et Belles Lettres* pp. 404–431, 1747, or [www3.bbaw.de/bibliothek/digital/struktur/03-nouv/1782/jpg-0600/00000495.htm](http://www3.bbaw.de/bibliothek/digital/struktur/03-nouv/1782/jpg-0600/00000495.htm). See also [en.wikipedia.org/wiki/Le\\_Sage's\\_theory\\_of\\_gravitation](http://en.wikipedia.org/wiki/Le_Sage's_theory_of_gravitation). In fact, the first to propose the idea of gravitation as a result of small particles pushing masses around was Nicolas Fatio de Duillier in 1688. Cited on page 176.
- 153** J. LASKAR, A numerical experiment on the chaotic behaviour of the solar system, *Nature* 338, pp. 237–238, 1989, and J. LASKAR, The chaotic motion of the solar system - A numerical estimate of the size of the chaotic zones, *Icarus* 88, pp. 266–291, 1990. The work by Laskar was later expanded by Jack Wisdom, using specially built computers, following only the planets, without taking into account the smaller objects. For more details, see G. J. SUSSMAN & J. WISDOM, Chaotic Evolution of the Solar System, *Science* 257, pp. 56–62, 1992. Today, such calculations can be performed on your home PC with computer code freely available on the internet. Cited on page 177.
- 154** B. DUBRULLE & F. GRANER, Titius-Bode laws in the solar system. 1: Scale invariance explains everything, *Astronomy and Astrophysics* 282, pp. 262–268, 1994, and Titius-Bode laws

- in the solar system. 2: Build your own law from disk models, *Astronomy and Astrophysics* 282, pp. 269--276, 1994. Cited on page 177.
- 155 M. LECAR, Bode's Law, *Nature* 242, pp. 318–319, 1973, and M. HENON, A comment on "The resonant structure of the solar system" by A.M. Molchanov, *Icarus* 11, pp. 93–94, 1969. Cited on page 177.
- 156 CASSIUS DIO, *Historia Romana*, c. 220, book 37, 18. For an English translation, see the site [penelope.uchicago.edu/Thayer/E/Roman/Texts/Cassius\\_Dio/37\\*.html](http://penelope.uchicago.edu/Thayer/E/Roman/Texts/Cassius_Dio/37*.html). Cited on page 178.
- 157 M. BEVIS, D. ALSDORF, E. KENDRICK, L. P. FORTES, B. FORSBERG, R. MALLEY & J. BECKER, Seasonal fluctuations in the mass of the Amazon River system and Earth's elastic response, *Geophysical Research Letters* 32, p. L16308, 2005. Cited on page 179.
- 158 D. HESTENES, M. WELLS & G. SWACKHAMER, Force concept inventory, *Physics Teacher* 30, pp. 141–158, 1982. The authors developed tests to check the understanding of the concept of physical force in students; the work has attracted a lot of attention in the field of physics teaching. Cited on page 184.
- 159 For a general overview on friction, from physics to economics, architecture and organizational theory, see N. ÅKERMAN, editor, *The Necessity of Friction – Nineteen Essays on a Vital Force*, Springer Verlag, 1993. Cited on page 187.
- 160 See M. HIRANO, K. SHINJO, R. KANECKO & Y. MURATA, Observation of superlubricity by scanning tunneling microscopy, *Physical Review Letters* 78, pp. 1448–1451, 1997. See also the discussion of their results by SERGE FAYEULLE, Superlubricity: when friction stops, *Physics World* pp. 29–30, May 1997. Cited on page 187.
- 161 DONALD AHRENS, *Meteorology Today: An Introduction to the Weather, Climate, and the Environment*, West Publishing Company, 1991. Cited on page 188.
- 162 This topic is discussed with lucidity by J. R. MUREIKA, What really are the best 100 m performances?, *Athletics: Canada's National Track and Field Running Magazine*, July 1997. It can also be found as [arxiv.org/abs/physics/9705004](http://arxiv.org/abs/physics/9705004), together with other papers on similar topics by the same author. Cited on page 188.
- 163 F. P. BOWDEN & D. TABOR, *The Friction and Lubrication of Solids*, Oxford University Press, Part I, revised edition, 1954, and part II, 1964. Cited on page 189.
- 164 A powerful book on human violence is JAMES GILLIGAN, *Violence – Our Deadly Epidemic and its Causes*, Grosset/Putnam, 1992. Cited on page 189.
- 165 The main tests of randomness of number series – among them the gorilla test – can be found in the authoritative paper by G. MARSAGLIA & W. W. TSANG, Some difficult-to-pass tests of randomness, *Journal of Statistical Software* 7, p. 8, 2002. It can also be downloaded from the [www.jstatsoft.org/v07/i03/tufstests.pdf](http://www.jstatsoft.org/v07/i03/tufstests.pdf) website. Cited on page 192.
- 166 For one aspect of the issue, see for example the captivating book by BERT HELLINGER, *Zweierlei Glück*, Carl Auer Systeme Verlag, 1997. The author explains how to live serenely and with the highest possible responsibility for one's actions, by reducing entanglements with the destiny of others. He describes a powerful technique to realise this goal.  
A completely different viewpoint is given by AUNG SAN SUU KYI, *Freedom from Fear*, Penguin, 1991. One of the bravest women on Earth, she won the Nobel Peace Prize in 1991. Cited on page 194.
- 167 HENRIK WALTER, *Neurophilosophie der Willensfreiheit*, Mentis Verlag, Paderborn 1999. Also available in English translation. Cited on page 194.
- 168 GIUSEPPE FUMAGALLI, *Chi l'ha detto?*, Hoepli, 1983. Cited on page 194.



- 169** See the tutorial on the Peaucellier-Lipkin linkage by D.W. Henderson and D. Taimina found on [kmoddl.library.cornell.edu/tutorials/11/index.php](http://kmoddl.library.cornell.edu/tutorials/11/index.php). The internet contains many other pages on the topic. Cited on page 196.
- 170** The beautiful story of the south-pointing carriage is told in Appendix B of JAMES FOSTER & J. D. NIGHTINGALE, *A Short Course in General Relativity*, Springer Verlag, 2nd edition, 1998. Such carriages have existed in China, as told by the great sinologist Joseph Needham, but their construction is unknown. The carriage described by Foster and Nightingale is the one reconstructed in 1947 by George Lancaster, a British engineer. Cited on page 196.
- 171** See for example Z. GHAHRAMANI, Building blocks of movement, *Nature* 407, pp. 682–683, 2000. Researchers in robot control are also interested in such topics. Cited on page 196.
- 172** G. GUTIERREZ, C. FEHR, A. CALZADILLA & D. FIGUEROA, Fluid flow up the wall of a spinning egg, *American Journal of Physics* 66, pp. 442–445, 1998. Cited on page 197.
- 173** A historical account is given in WOLFGANG YOURGRAY & STANLEY MANDELSTAM, *Variational Principles in Dynamics and Quantum Theory*, Dover, 1968. Cited on pages 199 and 207.
- 174** C. G. GRAY & E. F. TAYLOR, When action is not least, *American Journal of Physics* 75, pp. 434–458, 2007. Cited on page 204.
- 175** MAX PÄSLER, *Prinzipie der Mechanik*, Walter de Gruyter & Co., 1968. Cited on page 205.
- 176** The relations between possible Lagrangians are explained by HERBERT GOLDSTEIN, *Classical Mechanics*, 2nd edition, Addison-Wesley, 1980. Cited on page 205.
- 177** C. G. GRAY, G. KARL & V. A. NOVIKOV, From Maupertius to Schrödinger. Quantization of classical variational principles, *American Journal of Physics* 67, pp. 959–961, 1999. Cited on page 207.
- 178** The Hemingway statement is quoted by Marlene Dietrich in AARON E. HOTCHNER, *Papa Hemingway*, Random House, 1966, in part I, chapter I. Cited on page 206.
- 179** J. A. MOORE, An innovation in physics instruction for nonscience majors, *American Journal of Physics* 46, pp. 607–612, 1978. Cited on page 208.
- 180** See e.g. ALAN P. BOSS, Extrasolar planets, *Physics Today* 49, pp. 32–38. September 1996. The most recent information can be found at the ‘Extrasolar Planet Encyclopaedia’ maintained at [www.obspm.fr/planets](http://www.obspm.fr/planets) by Jean Schneider at the Observatoire de Paris. Cited on page 211.
- 181** A good review article is by DAVID W. HUGHES, Comets and Asteroids, *Contemporary Physics* 35, pp. 75–93, 1994. Cited on page 211.
- 182** G. B. WEST, J. H. BROWN & B. J. ENQUIST, A general model for the origin of allometric scaling laws in biology, *Science* 276, pp. 122–126, 4 April 1997, with a comment on page 34 of the same issue. The rules governing branching properties of blood vessels, of lymph systems and of vessel systems in plants are explained. For more about plants, see also the paper G. B. WEST, J. H. BROWN & B. J. ENQUIST, A general model for the structure and allometry of plant vascular systems, *Nature* 400, pp. 664–667, 1999. Cited on page 212.
- 183** J. R. BANAVAR, A. MARTIN & A. RINALDO, Size and form in efficient transportation networks, *Nature* 399, pp. 130–132, 1999. Cited on page 212.
- 184** N. MOREIRA, New striders - new humanoids with efficient gaits change the robotics landscape, *Science News Online* 6th of August, 2005. Cited on page 214.
- 185** JOHN MANSLEY ROBINSON, *An Introduction to Early Greek Philosophy*, Houghton Mifflin 1968, chapter 5. Cited on page 216.

- 186** See e.g. B. BOWER, A child's theory of mind, *Science News* 144, pp. 40–41. Cited on page 220.
- 187** The most beautiful book on this topic is the text by BRANKO GRÜNBAUM & G. C. SHEPHARD, *Tilings and Patterns*, W.H. Freeman and Company, New York, 1987. It has been translated into several languages and republished several times. Cited on page 221.
- 188** U. NIEDERER, The maximal kinematical invariance group of the free Schrödinger equation, *Helvetica Physica Acta* 45, pp. 802–810, 1972. See also the introduction by O. JAHN & V. V. SREEDHAR, The maximal invariance group of Newton's equations for a free point particle, [arxiv.org/abs/math-ph/0102011](https://arxiv.org/abs/math-ph/0102011). Cited on page 226.
- 189** The story is told in the interesting biography of Einstein by A. PAIS, 'Subtle is the Lord...' – *The Science and the Life of Albert Einstein*, Oxford University Press, 1982. Cited on page 227.
- 190** WERNER HEISENBERG, *Der Teil und das Ganze*, Piper, 1969. Cited on page 215.
- 191** See the clear presentation by E. H. LOCKWOOD & R. H. MACMILLAN, *Geometric Symmetry*, Cambridge University Press, 1978. Cited on page 215.
- 192** W. ZÜRN & R. WIDMER-SCHNIDRIG, Globale Eigenschwingungen der Erde, *Physik Journal* 1, pp. 49–55, 2002. Cited on page 235.
- 193** N. GAUTHIER, What happens to energy and momentum when two oppositely-moving wave pulses overlap?, *American Journal of Physics* 71, pp. 787–790, 2003. Cited on page 240.
- 194** An informative and modern summary of present research about the ear and the details of its function is [www.physicsweb.org/article/world/15/5/8](http://www.physicsweb.org/article/world/15/5/8). Cited on page 243.
- 195** S. ADACHI, Principles of sound production in wind instruments, *Acoustical Science and Technology* 25, pp. 400–404, 2004. Cited on page 246.
- 196** The literature on tones and their effects is vast. For example, people have explored the differences and effects of various intonations in great detail. Several websites, such as [bellsouthpwp.net/j/d/jdelaub/jstudio.htm](http://bellsouthpwp.net/j/d/jdelaub/jstudio.htm), allow listening to music played with different intonations. People have even researched whether animals use just or chromatic intonation. (See, for example, K. LEUTWYLER, Exploring the musical brain, *Scientific American* January 2001.) There are also studies of the effects of low frequencies, of beat notes, and of many other effects on humans. However, many studies mix serious and non-serious arguments. It is easy to get lost in them. Cited on page 247.
- 197** M. FATEMI, P. L. OGBURN & J. F. GREENLEAF, Fetal stimulation by pulsed diagnostic ultrasound, *Journal of Ultrasound in Medicine* 20, pp. 883–889, 2001. See also M. FATEMI, A. ALIZAD & J. F. GREENLEAF, Characteristics of the audio sound generated by ultrasound imaging systems, *Journal of the Acoustical Society of America* 117, pp. 1448–1455, 2005. Cited on pages 247 and 248.
- 198** I know a female gynecologist who, during her own pregnancy, imaged her child *every day* with her ultrasound machine. The baby was born with strong hearing problems that did not go away. Cited on page 248.
- 199** R. MOLE, Possible hazards of imaging and Doppler ultrasound in obstetrics, *Birth Issues in Perinatal Care* 13, pp. 29–37, 2007. Cited on page 248.
- 200** A. L. HODGKIN & A. F. HUXLEY, A quantitative description of membrane current and its application to conduction and excitation in nerve, *Journal of Physiology* 117, pp. 500–544, 1952. This famous paper of theoretical biology earned the authors the Nobel Prize in Medicine in 1963. Cited on page 250.

- 201** T. FILIPPOV, *The Versatile Soliton*, Springer Verlag, 2000. See also J. S. RUSSEL, Report of the Fourteenth Meeting of the British Association for the Advancement of Science, Murray, London, 1844, pp. 311–390. Cited on pages [250](#) and [252](#).
- 202** R. S. WARD, Solitons and other extended field configurations, preprint at [arxiv.org/abs/hep-th/0505135](http://arxiv.org/abs/hep-th/0505135). Cited on page [252](#).
- 203** D. B. BAHR, W. T. PFEFFER & R. C. BROWNING, The surprising motion of ski moguls, *Physics Today* **62**, pp. 68–69, November 2009. Cited on page [253](#).
- 204** N. J. ZABUSKY & M. D. KRUSKAL, Interaction of solitons in a collisionless plasma and the recurrence of initial states, *Physical Review Letters* **15**, pp. 240–243, 1965. Cited on page [252](#).
- 205** O. MUSKENS, De kortste knal ter wereld, *Nederlands tijdschrift voor natuurkunde* pp. 70–73, 2005. Cited on page [252](#).
- 206** E. HELLER, Freak waves: just bad luck, or avoidable?, *Europhysics News* pp. 159–161, September/October 2005, downloadable at [www.europhysicsnews.org](http://www.europhysicsnews.org). Cited on page [254](#).
- 207** For more about the ocean sound channel, see the novel by TOM CLANCY, *The Hunt for Red October*. See also the physics script by R. A. MULLER, Government secrets of the oceans, atmosphere, and UFOs, [web.archive.org/web/\\*/muller.lbl.gov/teaching/Physics10/chapters/9-SecretsofUFOs.html](http://web.archive.org/web/*/muller.lbl.gov/teaching/Physics10/chapters/9-SecretsofUFOs.html) 2001. Cited on page [256](#).
- 208** B. WILSON, R. S. BATTY & L. M. DILL, Pacific and Atlantic herring produce burst pulse sounds, *Biology Letters* **271**, number S3, 7 February 2004. Cited on page [256](#).
- 209** See for example the article by G. FRITSCH, Infraschall, *Physik in unserer Zeit* **13**, pp. 104–110, 1982. Cited on page [257](#).
- 210** Wavelet transformations were developed by the French mathematicians Alex Grossmann, Jean Morlet and Thierry Paul. The basic paper is A. GROSSMANN, J. MORLET & T. PAUL, Integral transforms associated to square integrable representations, *Journal of Mathematical Physics* **26**, pp. 2473–2479, 1985. For a modern introduction, see STÉPHANE MALLAT, *A Wavelet Tour of Signal Processing*, Academic Press, 1999. Cited on page [258](#).
- 211** P. MANOGG, Knall und Superknall beim Überschallflug, *Der mathematische und naturwissenschaftliche Unterricht* **35**, pp. 26–33, 1982. Cited on page [258](#).
- 212** See the excellent introduction by L. ELLERBROEK & VAN DEN HOORN, In het kielzog van Kelvin, *nederlands tijdschrift voor natuurkunde* **73**, pp. 310–313, 2007. Cited on page [259](#).
- 213** JAY INGRAM, *The Velocity of Honey - And More Science of Everyday Life*, Viking, 2003. See also W. W. L. AU & J. A. SIMMONS, Echolocation in dolphins and bats, *Physics Today* **60**, pp. 40–45, 2007. Cited on page [260](#).
- 214** M. BOITI, J. -P. LEON, L. MARTINA & F. PEMPINELLI, Scattering of localized solitons in the plane, *Physics Letters A* **132**, pp. 432–439, 1988, A. S. FOKAS & P. M. SANTINI, Coherent structures in multidimensions, *Physics Review Letters* **63**, pp. 1329–1333, 1989, J. HIETARINTA & R. HIROTA, Multidromion solutions to the Davey–Stewartson equation, *Physics Letters A* **145**, pp. 237–244, 1990. Cited on page [260](#).
- 215** The sound frequency change with bottle volume is explained on [hyperphysics.phy-astr.gsu.edu/Hbase/Waves/cavity.html](http://hyperphysics.phy-astr.gsu.edu/Hbase/Waves/cavity.html). Cited on page [261](#).
- 216** A passionate introduction is NEVILLE H. FLETCHER & THOMAS D. ROSSING, *The Physics of Musical Instruments*, second edition, Springer 2000. Cited on page [262](#).
- 217** M. AUSLOOS & D. H. BERMAN, Multivariate Weierstrass–Mandelbrot function, *Proceedings of the Royal Society in London A* **400**, pp. 331–350, 1985. Cited on page [263](#).

- 218** Catechism of the Catholic Church, Part Two, Section Two, Chapter One, Article 3, statements 1376, 1377 and 1413, found at [www.vatican.va/archive/ENG0015/\\_\\_\\_P41.HTM](http://www.vatican.va/archive/ENG0015/___P41.HTM) or [www.vatican.va/archive/ITA0014/\\_\\_\\_P40.HTM](http://www.vatican.va/archive/ITA0014/___P40.HTM) with their official explanations on [www.vatican.va/archive/compendium\\_ccc/documents/archive\\_2005\\_compendium-ccc\\_en.html](http://www.vatican.va/archive/compendium_ccc/documents/archive_2005_compendium-ccc_en.html) and [www.vatican.va/archive/compendium\\_ccc/documents/archive\\_2005\\_compendium-ccc\\_it.html](http://www.vatican.va/archive/compendium_ccc/documents/archive_2005_compendium-ccc_it.html). Cited on page 265.
- 219** The original text of the 1633 conviction of Galileo can be found on [it.wikisource.org/wiki/Sentenza\\_di\\_condanna\\_di\\_Galileo\\_Galilei](http://it.wikisource.org/wiki/Sentenza_di_condanna_di_Galileo_Galilei). Cited on page 266.
- 220** The retraction that Galileo was forced to sign in 1633 can be found on [it.wikisource.org/wiki/Abiura\\_di\\_Galileo\\_Galilei](http://it.wikisource.org/wiki/Abiura_di_Galileo_Galilei). Cited on page 266.
- 221** M. Artigas/ Un nuovo documento sul caso Galileo: EE 291, *Acta Philosophica* 10, pp. 199–214, 2001. Cited on page 266.
- 222** Most of these points are made, directly or indirectly, in the book by ANNIBALE FANTOLI, *Galileo: For Copernicanism and for the Church*, Vatican Observatory Publications, second edition, 1996, and by George Coyne, director of the Vatican observatory, in his speeches and publications, for example in G. COYNE, Galileo: for Copernicanism and for the church, *Zwoje* 3/36, 2003, found at [www.zwoje-scrolls.com/zwoje36/text05p.htm](http://www.zwoje-scrolls.com/zwoje36/text05p.htm). Cited on page 266.
- 223** T. A. MCMAHOB & J. TYLER BONNER, *Form und Leben – Konstruktion vom Reißbrett der Natur*, Spektrum Verlag, 1985. Cited on page 267.
- 224** G. W. KOCH, S. C. SILLETT, G. M. JENNINGS & S. D. DAVIS, The limits to tree height, *Nature* 428, pp. 851–854, 2004. Cited on page 267.
- 225** A simple article explaining the tallness of trees is A. MINEYEV, Trees worthy of Paul Bunyan, *Quantum* pp. 4–10, January–February 1994. (Paul Bunyan is a mythical giant lumberjack who is the hero of the early frontier pioneers in the United States.) Note that the transport of liquids in trees sets no limits on their height, since water is pumped up along tree stems (except in spring, when it is pumped up from the roots) by evaporation from the leaves. This works almost without limits because water columns, when nucleation is carefully avoided, can be put under tensile stresses of over 100 bar, corresponding to 1000 m. See also P. NOBEL, *Plant Physiology*, Academic Press, 2nd Edition, 1999. An artificial tree – though extremely small – using the same mechanism was built and studied by T. D. WHEELER & A. D. STROOCK, The transpiration of water at negative pressures in a synthetic tree, *Nature* 455, pp. 208–212, 2008. See also N. M. HOLBROOK & M. A. ZWIENIECKI, Transporting water to the top of trees, *Physics Today* pp. 76–77, 2008. Cited on pages 268 and 270.
- 226** Such information can be taken from the excellent overview article by M. F. ASHBY, On the engineering properties of materials, *Acta Metallurgica* 37, pp. 1273–1293, 1989. The article explains the various general criteria which determine the selection of materials, and gives numerous tables to guide the selection. Cited on page 268.
- 227** The present record for negative pressure in water was achieved by Q. ZHENG, D. J. DURBEN, G. H. WOLF & C. A. ANGELL, Liquids at large negative pressures: water at the homogeneous nucleation limit, *Science* 254, pp. 829–832, 1991. Cited on page 270.
- 228** H. MARIS & S. BALIBAR, Negative pressures and cavitation in liquid helium, *Physics Today* 53, pp. 29–34, 2000. Cited on page 270.
- 229** For a photograph of a single barium atom – named Astrid – see HANS DEHMELT, Experiments with an isolated subatomic particle at rest, *Reviews of Modern Physics* 62, pp. 525–530, 1990. For another photograph of a barium ion, see W. NEUHAUSER, M. HOHENSTATT,

- P. E. TOSCHEK & H. DEHMELT, Localized visible Ba<sup>+</sup> mono-ion oscillator, *Physical Review A* 22, pp. 1137–1140, 1980. See also the photograph on [page 273](#). Cited on page [272](#).
- 230** Holograms of atoms were first produced by HANS-WERNER FINK & al., Atomic resolution in lens-less low-energy electron holography, *Physical Review Letters* 67, pp. 1543–1546, 1991. Cited on page [272](#).
- 231** A single-atom laser was built in 1994 by K. AN, J. J. CHILDS, R. R. DASARI & M. S. FELD, Microlaser: a laser with one atom in an optical resonator, *Physical Review Letters* 73, p. 3375, 1994. Cited on page [272](#).
- 232** The photograph on [page 272](#) is the first image that showed subatomic structures (visible as shadows on the atoms). It was published by F. J. GIESSIBL, S. HEMBACHER, H. BIELEFELDT & J. MANNHART, Subatomic features on the silicon (111)-(7x7) surface observed by atomic force microscopy, *Science* 289, pp. 422 – 425, 2000. Cited on page [272](#).
- 233** See for example C. SCHILLER, A. A. KOOMANS, VAN ROOY, C. SCHÖNENBERGER & H. B. ELSWIJK, Decapitation of tungsten field emitter tips during sputter sharpening, *Surface Science Letters* 339, pp. L925–L930, 1996. Cited on page [272](#).
- 234** U. WEIERSTALL & J. C. H. SPENCE, An STM with time-of-flight analyzer for atomic species identification, MSA 2000, Philadelphia, *Microscopy and Microanalysis* 6, Supplement 2, p. 718, 2000. Cited on page [272](#).
- 235** M. J. HANCOCK & J. W. M. BUSH, Fluid pipes, *Journal of Fluid Mechanics* 466, pp. 285–304, 2002. A. E. HOSOI & J. W. M. BUSH, Evaporative instabilities in climbing films, *Journal of Fluid Mechanics* 442, pp. 217–239, 2001. J. W. M. BUSH & A. E. HASHA, On the collision of laminar jets: fluid chains and fishbones, *Journal of Fluid Mechanics* 511, pp. 285–310, 2004. Cited on page [273](#).
- 236** The present state of our understanding of turbulence is described by G. FALKOVICH & K. P. SREENIVASAN, Lessons from hydrodynamic turbulence, *Physics Today* 59, pp. 43–49, 2006. Cited on page [275](#).
- 237** K. WELTNER, A comparison of explanations of aerodynamical lifting force, *American Journal of Physics* 55, pp. 50–54, 1987, K. WELTNER, Aerodynamic lifting force, *The Physics Teacher* 28, pp. 78–82, 1990. See also the [user.uni-frankfurt.de/~weltner/Flight/PHYSIC4.htm](http://user.uni-frankfurt.de/~weltner/Flight/PHYSIC4.htm) and the [www.av8n.com/how/htm/airfoils.html](http://www.av8n.com/how/htm/airfoils.html) websites. Cited on page [276](#).
- 238** For a fascinating account of the passion and the techniques of apnoea diving, see UMBERTO PELIZZARI, *L'Homme et la mer*, Flammarion, 1994. Palizzari cites and explains the saying by Enzo Maiorca: ‘The first breath you take when you come back to the surface is like the first breath with which you enter life.’ Cited on page [277](#).
- 239** LYDÉRIC BOCQUET, The physics of stone skipping, *American Journal of Physics* 17, pp. 150–155, 2003. The present record holder is Kurt Steiner, with 40 skips. See [pastoneskipping.com/steiner.htm](http://pastoneskipping.com/steiner.htm) and [www.stoneskipping.com](http://www.stoneskipping.com). The site [www.yeeha.net/nassa/guin/g2.html](http://www.yeeha.net/nassa/guin/g2.html) is by the a previous world record holder, Jerdome Coleman-McGhee. Cited on page [279](#).
- 240** S. F. KISTLER & L. E. SCRIVEN, The teapot effect: sheetforming flows with deflection, wetting, and hysteresis, *Journal of Fluid Mechanics* 263, pp. 19–62, 1994. Cited on page [281](#).
- 241** J. WALKER, Boiling and the Leidenfrost effect, a chapter from DAVID HALLIDAY, ROBERT RESNICK & JEARL WALKER, *Fundamentals of Physics*, Wiley, 2007. The chapter can also be found on the internet as pdf file. Cited on page [282](#).
- 242** E. HOLLANDER, Over trechters en zo ..., *Nederlands tijdschrift voor natuurkunde* 68, p. 303, 2002. Cited on page [282](#).



- 243** S. DORBOLO, H. CAPS & N. VANDEWALLE, Fluid instabilities in the birth and death of antibubbles, *New Journal of Physics* 5, p. 161, 2003. Cited on page 283.
- 244** T. T. LIM, A note on the leapfrogging between two coaxial vortex rings at low Reynolds numbers, *Physics of Fluids* 9, pp. 239–241, 1997. Cited on page 284.
- 245** P. KREHL, S. ENGEMANN & D. SCHWENKEL, The puzzle of whip cracking – uncovered by a correlation of whip-tip kinematics with shock wave emission, *Shock Waves* 8, pp. 1–9, 1998. The authors used high-speed cameras to study the motion of the whip. A new aspect has been added by A. GORIELY & T. McMILLEN, Shape of a cracking whip, *Physical Review Letters* 88, p. 244301, 2002. This article focuses on the tapered shape of the whip. However, the neglect of the tuft – a piece at the end of the whip which is required to make it crack – in the latter paper shows that there is more to be discovered still. Cited on page 287.
- 246** Z. SHENG & K. YAMAFUJI, Realization of a Human Riding a Unicycle by a Robot, *Proceedings of the 1995 IEEE International Conference on Robotics and Automation*, Vol. 2, pp. 1319–1326, 1995. Cited on page 288.
- 247** On human uncycling, see JACK WILEY, *The Complete Book of Unicycling*, Lodi, 1984, and SEBASTIAN HOEHER, *Einradfahren und die Physik*, Reinbeck, 1991. Cited on page 288.
- 248** W. THOMSON, Lecture to the Royal Society of Edinburgh, 18 February 1867, *Proceedings of the Royal Society in Edinburgh* 6, p. 94, 1869. Cited on page 288.
- 249** S. T. THORODDSEN & A. Q. SHEN, Granular jets, *Physics of Fluids* 13, pp. 4–6, 2001, and A. Q. SHEN & S. T. THORODDSEN, Granular jetting, *Physics of Fluids* 14, p. S3, 2002, Cited on page 288.
- 250** F. HERRMANN, Mengenartige Größen im Physikunterricht, *Physikalische Blätter* 54, pp. 830–832, September 1998. See also his lecture notes on general introductory physics on the website [www.physikdidaktik.uni-karlsruhe.de/skripten](http://www.physikdidaktik.uni-karlsruhe.de/skripten). Cited on pages 185, 291, and 297.
- 251** Thermostatics and thermodynamics is difficult to learn also because it was not discovered in a systematic way. See C. TRUESDELL, *The Tragicomical History of Thermodynamics 1822–1854*, Springer Verlag, 1980. An excellent advanced textbook on thermostatics and thermodynamics is LINDA REICHL, *A Modern Course in Statistical Physics*, Wiley, 2nd edition, 1998. Cited on page 292.
- 252** Gas expansion was the main method used for the definition of the official temperature scale. Only in 1990 were other methods introduced officially, such as total radiation thermometry (in the range 140 K to 373 K), noise thermometry (2 K to 4 K and 900 K to 1235 K), acoustical thermometry (around 303 K), magnetic thermometry (0.5 K to 2.6 K) and optical radiation thermometry (above 730 K). Radiation thermometry is still the central method in the range from about 3 K to about 1000 K. This is explained in detail in R. L. RUSBY, R. P. HUDSON, M. DURIEUX, J. F. SCHOOLEY, P. P. M. STEUR & C. A. SWENSON, The basis of the ITS-90, *Metrologia* 28, pp. 9–18, 1991. On the water boiling point see also Ref. 332. Cited on page 292.
- 253** Other methods to rig lottery draws made use of balls of different mass or of balls that are more polished. One example of such a scam was uncovered in 1999. Cited on page 293.
- 254** See for example the captivating text by GINO SEGRÈ, *A Matter of Degrees: What Temperature Reveals About the Past and Future of Our Species, Planet and Universe*, Viking, New York, 2002. Cited on page 294.
- 255** D. KARSTÄDT, F. PINNO, K. -P. MÖLLMANN & M. VOLLMER, Anschauliche Wärmelehre im Unterricht: ein Beitrag zur Visualisierung thermischer Vorgänge, *Praxis der*

- Naturwissenschaften Physik* 5-48, pp. 24–31, 1999, K. -P. MÖLLMANN & M. VOLLMER, Eine etwas andere, physikalische Sehweise - Visualisierung von Energieumwandlungen und Strahlungsphysik für die (Hochschul-)lehre, *Physikalische Blätter* 56, pp. 65–69, 2000, D. KARSTÄDT, K. -P. MÖLLMANN, F. PINNO & M. VOLLMER, There is more to see than eyes can detect: visualization of energy transfer processes and the laws of radiation for physics education, *The Physics Teacher* 39, pp. 371–376, 2001, K. -P. MÖLLMANN & M. VOLLMER, Infrared thermal imaging as a tool in university physics education, *European Journal of Physics* 28, pp. S37–S50, 2007. Cited on page 294.
- 256** B. POLSTER, What is the best way to lace your shoes?, *Nature* 420, p. 476, 5 December 2002. Cited on page 298.
- 257** L. BOLTZMANN, Über die mechanische Bedeutung des zweiten Hauptsatzes der Wärmetheorie, *Sitzungsberichte der königlichen Akademie der Wissenschaften in Wien* 53, pp. 155–220, 1866. Cited on page 299.
- 258** See for example the article by H. PRESTON-THOMAS, The international temperature scale of 1990 (ITS-90), *Metrologia* 27, pp. 3–10, 1990, and the errata H. PRESTON-THOMAS, The international temperature scale of 1990 (ITS-90), *Metrologia* 27, p. 107, 1990, Cited on page 302.
- 259** For an overview, see CHRISTIAN ENSS & SIEGFRIED HUNKLINGER, *Low-Temperature Physics*, Springer, 2005. Cited on page 302.
- 260** The famous paper on Brownian motion which contributed so much to Einstein's fame is A. EINSTEIN, Über die von der molekularkinetischen Theorie der Wärme geforderte Bewegung von in ruhenden Flüssigkeiten suspendierten Teilchen, *Annalen der Physik* 17, pp. 549–560, 1905. In the following years, Einstein wrote a series of further papers elaborating on this topic. For example, he published his 1905 Ph.D. thesis as A. EINSTEIN, Eine neue Bestimmung der Moleküldimensionen, *Annalen der Physik* 19, pp. 289–306, 1906, and he corrected a small mistake in A. EINSTEIN, Berichtigung zu meiner Arbeit: 'Eine neue Bestimmung der Moleküldimensionen', *Annalen der Physik* 34, pp. 591–592, 1911, where, using new data, he found the value  $6.6 \cdot 10^{23}$  for Avogadro's number. However, five years before Smoluchowski and Einstein, a much more practically-minded man had made the same calculations, but in a different domain: the mathematician Louis Bachelier did so in his PhD about stock options; this young financial analyst was thus smarter than Einstein. Cited on page 303.
- 261** The first experimental confirmation of the prediction was performed by J. PERRIN, *Comptes Rendus de l'Académie des Sciences* 147, pp. 475–476, and pp. 530–532, 1908. He masterfully sums up the whole discussion in JEAN PERRIN, *Les atomes*, Librairie Félix Alcan, Paris, 1913. Cited on page 304.
- 262** PIERRE GASPARD & al., Experimental evidence for microscopic chaos, *Nature* 394, p. 865, 27 August 1998. Cited on page 304.
- 263** These points are made clearly and forcibly, as is his style, by VAN KAMPEN, Entropie, *Nederlands tijdschrift voor natuurkunde* 62, pp. 395–396, 3 December 1996. Cited on page 305.
- 264** This is a disappointing result of all efforts so far, as Grégoire Nicolis always stresses in his university courses. Seth Lloyd has compiled a list of 31 proposed definitions of complexity, containing among others, fractal dimension, grammatical complexity, computational complexity, thermodynamic depth. See, for example, a short summary in *Scientific American* p. 77, June 1995. Cited on page 306.
- 265** Minimal entropy is discussed by L. SZILARD, Über die Entropieverminderung in einem thermodynamischen System bei Eingriffen intelligenter Wesen, *Zeitschrift für Physik* 53,



- pp. 840–856, 1929. This classic paper can also be found in English translation in his collected works. Cited on page 306.
- 266** G. COHEN-TANNOUJJI, *Les constantes universelles*, Pluriel, Hachette, 1998. See also L. BRILLOUIN, *Science and Information Theory*, Academic Press, 1962. Cited on pages 306 and 307.
- 267** H. W. ZIMMERMANN, Particle entropies and entropy quanta IV: the ideal gas, the second law of thermodynamics, and the P-t uncertainty relation, *Zeitschrift für physikalische Chemie* 217, pp. 55–78, 2003, and H. W. ZIMMERMANN, Particle entropies and entropy quanta V: the P-t uncertainty relation, *Zeitschrift für physikalische Chemie* 217, pp. 1097–1108, 2003. Cited on page 307.
- 268** See for example A. E. SHALYT-MARGOLIN & A. YA. TREGUBOVICH, Generalized uncertainty relation in thermodynamics, [arxiv.org/abs/gr-qc/0307018](https://arxiv.org/abs/gr-qc/0307018), or J. UFFINK & VAN LITH-VAN DIS, Thermodynamic uncertainty relations, *Foundations of Physics* 29, p. 655, 1999. Cited on page 307.
- 269** B. LAVENDA, *Statistical Physics: A Probabilistic Approach*, Wiley-Interscience, New York, 1991. Cited on page 307.
- 270** The quote is found in the introduction by George Wald to the text by LAWRENCE J. HENDERSON, *The Fitness of the Environment*, Macmillan, New York, 1913, reprinted 1958. Cited on page 308.
- 271** A fascinating introduction to chemistry is the text by JOHN EMSLEY, *Molecules at an Exhibition*, Oxford University Press, 1998. Cited on page 309.
- 272** An excellent introduction into the physics of heat is the book by LINDA REICHL, *A Modern Course in Statistical Physics*, Wiley, 2nd edition, 1998. Cited on page 310.
- 273** H. DE LANG, Moleculaire gastronomie, *Nederlands Tijdschrift voor Natuurkunde* 74, pp. 431–433, 2008. Cited on page 311.
- 274** EMILE BOREL, *Introduction géométrique à la physique*, Gauthier-Villars, 1912. Cited on page 311.
- 275** See V. L. TELEGGI, Enrico Fermi in America, *Physics Today* 55, pp. 38–43, June 2002. Cited on page 311.
- 276** K. SCHMIDT-NIELSEN, *Desert Animals: Physiological Problems of Heat and Water*, Oxford University Press, 1964. Cited on page 312.
- 277** Why entropy is created when information is erased, but not when it is acquired, is explained in C. H. BENNETT & R. LANDAUER, Fundamental Limits of Computation, *Scientific American* 253:1, pp. 48–56, 1985. The conclusion: we should pay to throw the newspaper away, not to buy it. Cited on page 314.
- 278** See, for example, G. SWIFT, Thermoacoustic engines and refrigerators, *Physics Today* 48, pp. 22–28, July 1995. Cited on page 316.
- 279** Quoted in D. CAMPBELL, J. CRUTCHFIELD, J. FARMER & E. JEN, Experimental mathematics: the role of computation in nonlinear science, *Communications of the Association of Computing Machinery* 28, pp. 374–384, 1985. Cited on page 318.
- 280** For more about the shapes of snowflakes, see the famous book by W. A. BENTLEY & W. J. HUMPHREYS, *Snow Crystals*, Dover Publications, New York, 1962. This second printing of the original from 1931 shows a large part of the result of Bentley's lifelong passion, namely several thousand photographs of snowflakes. Cited on page 318.
- 281** K. SCHWENK, Why snakes have forked tongues, *Science* 263, pp. 1573–1577, 1994. Cited on page 318.

- 282** E. MARTÍNEZ, C. PÉREZ-PENICHER, O. SOTOLONGO-COSTA, O. RAMOS, K. J. MÅLØY, S. DOUADY, E. ALTSHULER, Uphill solitary waves in granular flows, *Physical Review* **75**, p. 031303, 2007, and E. ALTSHULER, O. RAMOS, E. MARTÍNEZ, A. J. BATISTA-LEYVA, A. RIVERA & K. E. BASSLER, Sandpile formation by revolving rivers, *Physical Review Letters* **91**, p. 014501, 2003. Cited on page [319](#).
- 283** P. B. UMBANHOWAR, F. MELO & H. L. SWINNEY, Localized excitations in a vertically vibrated granular layer, *Nature* **382**, pp. 793–796, 29 August 1996. Cited on page [320](#).
- 284** D. K. CAMPBELL, S. FLACH & Y. S. KIVSHAR, Localizing energy through nonlinearity and discreteness, *Physics Today* **57**, pp. 43–49, January 2004. Cited on page [321](#).
- 285** B. ANDREOTTI, The song of dunes as a wave-particle mode locking, *Physical Review Letters* **92**, p. 238001, 2004. Cited on page [321](#).
- 286** D. C. MAYS & B. A. FAYBISHENKO, Washboards in unpaved highways as a complex dynamic system, *Complexity* **5**, pp. 51–60, 2000. See also N. TABERLET, S. W. MORRIS & J. N. MCELWAIN, Washboard road: the dynamics of granular ripples formed by rolling wheels, *Physical Review Letters* **99**, p. 068003, 2007. Cited on pages [321](#) and [437](#).
- 287** K. KÖTTER, E. GOLES & M. MARKUS, Shell structures with ‘magic numbers’ of spheres in a swirled disk, *Physical Review E* **60**, pp. 7182–7185, 1999. Cited on page [321](#).
- 288** A good introduction is the text by DANIEL WALGRAEF, *Spatiotemporal Pattern Formation, With Examples in Physics, Chemistry and Materials Science*, Springer 1996. Cited on page [322](#).
- 289** For an overview, see the Ph.D. thesis by JOCELINE LEGA, *Défauts topologiques associés à la brisure de l’invariance de translation dans le temps*, Université de Nice, 1989. Cited on page [323](#).
- 290** An idea of the fascinating mechanisms at the basis of the heart beat is given by A. BABLOYANTZ & A. DESTEXHE, Is the normal heart a periodic oscillator?, *Biological Cybernetics* **58**, pp. 203–211, 1989. Cited on page [324](#).
- 291** For a short, modern overview of turbulence, see L. P. KADANOFF, A model of turbulence, *Physics Today* **48**, pp. 11–13, September 1995. Cited on page [325](#).
- 292** For a clear introduction, see T. SCHMIDT & M. MAHRL, A simple mathematical model of a dripping tap, *European Journal of Physics* **18**, pp. 377–383, 1997. Cited on page [325](#).
- 293** An overview of science humour can be found in the famous anthology compiled by R. L. WEBER, edited by E. MENDOZA, *A Random Walk in Science*, Institute of Physics, 1973. It is also available in several expanded translations. Cited on page [325](#).
- 294** W. DREYBRODT, Physik von Stalagmiten, *Physik in unserer Zeit* pp. 25–30, *Physik in unserer Zeit* February 2009. Cited on page [326](#).
- 295** K. MERTENS, V. PUTKARADZE & P. VOROBIEFF, Braiding patterns on an inclined plane, *Nature* **430**, p. 165, 2004. Cited on page [327](#).
- 296** These beautifully simple experiments were published in G. MÜLLER, Starch columns: analog model for basalt columns, *Journal of Geophysical Research* **103**, pp. 15239–15253, 1998, in G. MÜLLER, Experimental simulation of basalt columns, *Journal of Volcanology and Geothermal Research* **86**, pp. 93–96, 1998, and in G. MÜLLER, Trocknungsrisse in Stärke, *Physikalische Blätter* **55**, pp. 35–37, 1999. Cited on page [327](#).
- 297** B. HOF, C. W. H. VAN DOORNE, J. WESTERWEEL, F. T. M. NIEUWSTADT, H. WEDIN, R. KERSWELL, F. WALEFFE, H. FAISST & B. ECKHARDT, Experimental observation of nonlinear traveling waves in turbulent pipe flow, *Science* **305**, pp. 1594–1598, 2004. Cited on page [328](#).

- 298** A fascinating book on the topic is KENNETH LAWS & MARTHA SWOPE, *Physics and the Art of Dance: Understanding Movement*, Oxford University Press 2002. Cited on page 329.
- 299** JOSEF H. REICHHOLF, *Eine kurze Naturgeschichte des letzten Jahrtausends*, S. Fischer Verlag, 2007. Cited on page 329.
- 300** See for example, E. F. BUNN, Evolution and the second law of thermodynamics, *American Journal of Physics* 77, pp. 922–925, 2009. Cited on page 329.
- 301** A good introduction of the physics of bird swarms is T. FEDER, Statistical physics is for the birds, *Physics Today* 60, pp. 28–30, October 2007. Cited on page 330.
- 302** J. J. LISSAUER, Chaotic motion in the solar system, *Reviews of Modern Physics* 71, pp. 835–845, 1999. Cited on page 331.
- 303** See JEAN-PAUL DUMONT, *Les écoles présocratiques*, Folio Essais, Gallimard, 1991, p. 426. Cited on page 332.
- 304** For a clear overview of the various sign conventions in general relativity, see the front cover of CHARLES W. MISNER, KIP S. THORNE & JOHN A. WHEELER, *Gravitation*, Freeman, 1973. We use the gravitational sign conventions of HANS C. OHANIAN & REMO RUFFINI, *Gravitazione e spazio-tempo*, Zanichelli, 1997. Cited on page 336.
- 305** GEORGE BIRKBECK NORMAN HILL, *Johnsonian Miscellanies*, Clarendon Press, 1897, in Seward's Biographiana/ Cited on page 336.
- 306** The first written record of the letter U seems to be LEON BATTISTA ALBERTI, *Grammatica della lingua toscana*, 1442, the first grammar of a modern (non-latin) language, written by a genius that was intellectual, architect and the father of cryptology. The first written record of the letter J seems to be ANTONIO DE NEBRIJA, *Gramática castellana*, 1492. Before writing it, Nebrija lived for ten years in Italy, so that it is possible that the I/J distinction is of Italian origin as well. Nebrija was one of the most important Spanish scholars. Cited on page 337.
- 307** For more information about the letters thorn and eth, have a look at the extensive report to be found on the website [www.everytype.com/standards/wynnyogh/thorn.html](http://www.everytype.com/standards/wynnyogh/thorn.html). Cited on page 337.
- 308** For a modern history of the English language, see DAVID CRYSTAL, *The Stories of English*, Allen Lane, 2004. Cited on page 337.
- 309** HANS JENSEN, *Die Schrift*, Berlin, 1969, translated into English as *Sign, Symbol and Script: an Account of Man's Efforts to Write*, Putnam's Sons, 1970. Cited on page 338.
- 310** DAVID R. LIDE, editor, *CRC Handbook of Chemistry and Physics*, 78th edition, CRC Press, 1997. This classic reference work appears in a new edition every year. The full Hebrew alphabet is given on page 2-90. The list of abbreviations of physical quantities for use in formulae approved by ISO, IUPAP and IUPAC can also be found there.  
However, the ISO 31 standard, which defines these abbreviations, costs around a thousand euro, is not available on the internet, and therefore can safely be ignored, like any standard that is supposed to be used in teaching but is kept inaccessible to teachers. Cited on pages 340 and 341.
- 311** See the mighty text by PETER T. DANIELS & WILLIAM BRIGHT, *The World's Writing Systems*, Oxford University Press, 1996. Cited on page 340.
- 312** The story of the development of the numbers is told most interestingly by GEORGES IFRAH, *Histoire universelle des chiffres*, Seghers, 1981, which has been translated into several languages. He sums up the genealogy of the number signs in ten beautiful tables, one for each digit, at the end of the book. However, the book itself contains factual errors on every page, as explained for example in the review found at [www.ams.org/](http://www.ams.org/)

- [notices/200201/rev-dauben.pdf](#) and [www.ams.org/notices/200202/rev-dauben.pdf](#). Cited on page 340.
- 313** See for example the fascinating book by STEVEN B. SMITH, *The Great Mental Calculators – The Psychology, Methods and Lives of the Calculating Prodigies*, Columbia University Press, 1983. The book also presents the techniques that they use, and that anybody else can use to emulate them. Cited on page 341.
- 314** See for example the article ‘Mathematical notation’ in the *Encyclopedia of Mathematics*, 10 volumes, Kluwer Academic Publishers, 1988–1993. But first all, have a look at the informative and beautiful [jeff560.tripod.com/mathsym.html](#) website. The main source for all these results is the classic and extensive research by FLORIAN CAJORI, *A History of Mathematical Notations*, 2 volumes, The Open Court Publishing Co., 1928–1929. The square root sign is used in CHRISTOFF RUDOLFF, *Die Coss*, Vuolfius Cephaleus Joanni Jung: Argentorati, 1525. (The full title was *Behend vnnd Hubsch Rechnung durch die kunstreichen regeln Algebre so gemeinlicklich die Coss genent werden. Darinnen alles so treulich an tag gegeben, das auch allein auss vleissigem lesen on allen mündtlichē vnerricht mag begriffen werden, etc.*) Cited on page 341.
- 315** J. TSCHICHOLD, *Formenwamdlungen der et-Zeichen*, Stempel AG, 1953. Cited on page 343.
- 316** MALCOLM B. PARKES, *Pause and Effect: An Introduction to the History of Punctuation in the West*, University of California Press, 1993. Cited on page 343.
- 317** This is explained by BERTHOLD LOUIS ULLMAN, *Ancient Writing and its Influence*, 1932. Cited on page 343.
- 318** PAUL LEHMANN, *Erforschung des Mittelalters – Ausgewählte Abhandlungen und Aufsätze*, Anton Hiersemann, 1961, pp. 4–21. Cited on page 343.
- 319** BERNARD BISCHOFF, *Paläographie des römischen Altertums und des abendländischen Mittelalters*, Erich Schmidt Verlag, 1979, pp. 215–219. Cited on page 343.
- 320** HUTTON WEBSTER, *Rest Days: A Study in Early Law and Morality*, MacMillan, 1916. The discovery of the unlucky day in Babylonia was made in 1869 by George Smith, who also rediscovered the famous *Epic of Gilgamesh*. Cited on page 344.
- 321** The connections between Greek roots and many French words – and thus many English ones – can be used to rapidly build up a vocabulary of ancient Greek without much study, as shown by the practical collection by J. CHAINEUX, *Quelques racines grecques*, Wetteren – De Meester, 1929. See also DONALD M. AYERS, *English Words from Latin and Greek Elements*, University of Arizona Press, 1986. Cited on page 345.
- 322** In order to write well, read WILLIAM STRUNK & E. B. WHITE, *The Elements of Style*, Macmillan, 1935, 1979, or WOLF SCHNEIDER, *Deutsch für Kenner – Die neue Stilkunde*, Gruner und Jahr, 1987. Cited on page 346.
- 323** Le Système International d’Unités, Bureau International des Poids et Mesures, Pavillon de Breteuil, Parc de Saint Cloud, 92310 Sèvres, France. All new developments concerning SI units are published in the journal *Metrologia*, edited by the same body. Showing the slow pace of an old institution, the BIPM launched a website only in 1998; it is now reachable at [www.bipm.fr](#). See also the [www.utc.fr/~tthomass/Themes/Unites/index.html](#) website; this includes the biographies of people who gave their names to various units. The site of its British equivalent, [www.npl.co.uk/npl/reference](#), is much better; it provides many details as well as the English-language version of the SI unit definitions. Cited on page 347.
- 324** The bible in the field of time measurement is the two-volume work by J. VANIER & C. AUDOIN, *The Quantum Physics of Atomic Frequency Standards*, Adam Hilge, 1989. A

popular account is TONY JONES, *Splitting the Second*, Institute of Physics Publishing, 2000.

The site [opdafl.obspm.fr/www/lexique.html](http://opdafl.obspm.fr/www/lexique.html) gives a glossary of terms used in the field. For precision *length* measurements, the tools of choice are special lasers, such as mode-locked lasers and frequency combs. There is a huge literature on these topics. Equally large is the literature on precision *electric current* measurements; there is a race going on for the best way to do this: counting charges or measuring magnetic forces. The issue is still open. On *mass* and atomic mass measurements, see the volume on relativity. On high-precision *temperature* measurements, see [page 425](#). Cited on [page 348](#).

Vol. II, page 64

- 325** The unofficial prefixes were first proposed in the 1990s by Jeff K. Aronson of the University of Oxford, and might come into general usage in the future. Cited on [page 349](#).
- 326** For more details on electromagnetic unit systems, see the standard text by JOHN DAVID JACKSON, *Classical Electrodynamics*, 3rd edition, Wiley, 1998. No citations.
- 327** G. J. STONEY, On the physical units of nature, *Philosophical Magazine* 11, pp. 381–391, 1881. No citations.
- 328** D. J. BIRD & al., Evidence for correlated changes in the spectrum and composition of cosmic rays at extremely high energies, *Physical Review Letters* 71, pp. 3401–3404, 1993. No citations.
- 329** P. J. HAKONEN, R. T. VUORINEN & J. E. MARTIKAINEN, Nuclear antiferromagnetism in rhodium metal at positive and negative nanokelvin temperatures, *Physical Review Letters* 70, pp. 2818–2821, 1993. See also his article in *Scientific American*, January 1994. No citations.
- 330** The most precise clock built in 2004, a caesium fountain clock, had a precision of one part in  $10^{15}$ . Higher precision has been predicted to be possible soon, among others by M. TAKAMOTO, F. -L. HONG, R. HIGASHI & H. KATORI, An optical lattice clock, *Nature* 435, pp. 321–324, 2005. Cited on [page 350](#).
- 331** J. BERGQUIST, ed., *Proceedings of the Fifth Symposium on Frequency Standards and Metrology*, World Scientific, 1997. Cited on [page 350](#).
- 332** Following a private communication by Richard Rusby, this is the value of 1997, whereas it was estimated as 99.975°C in 1989, as reported by GARETH JONES & RICHARD RUSBY, Official: water boils at 99.975°C, *Physics World* 2, pp. 23–24, September 1989, and R. L. RUSBY, Ironing out the standard scale, *Nature* 338, p. 1169, March 1989. For more details on temperature measurements, see [page 425](#). Cited on [pages 351](#) and [425](#).
- 333** J. SHORT, Newton's apples fall from grace, *New Scientist* 2098, p. 5, 6 September 1997. More details can be found in R. G. KEESING, The history of Newton's apple tree, *Contemporary Physics* 39, pp. 377–391, 1998. Cited on [page 352](#).
- 334** The various concepts are even the topic of a separate international standard, ISO 5725, with the title *Accuracy and precision of measurement methods and results*. A good introduction is JOHN R. TAYLOR, *An Introduction to Error Analysis: the Study of Uncertainties in Physical Measurements*, 2nd edition, University Science Books, Sausalito, 1997. Cited on [page 353](#).
- 335** P. J. MOHR & B. N. TAYLOR, CODATA recommended values of the fundamental physical constants: 1998, *Reviews of Modern Physics* 59, p. 351, 2000. This is the set of constants resulting from an international adjustment and recommended for international use by the Committee on Data for Science and Technology (CODATA), a body in the International Council of Scientific Unions, which brings together the International Union of Pure and Applied Physics (IUPAP), the International Union of Pure and Applied Chemistry (IUPAC) and other organizations. The website of IUPAC is [www.iupac.org](http://www.iupac.org). Cited on [pages 353](#) and [354](#).



- 336** Some of the stories can be found in the text by N. W. WISE, *The Values of Precision*, Princeton University Press, 1994. The field of high-precision measurements, from which the results on these pages stem, is a world on its own. A beautiful introduction to it is J. D. FAIRBANKS, B. S. DEEVER, C. W. EVERITT & P. F. MICHAELSON, eds., *Near Zero: Frontiers of Physics*, Freeman, 1988. Cited on page 353.
- 337** The details are given in the well-known astronomical reference, KENNETH SEIDELMANN, *Explanatory Supplement to the Astronomical Almanac*, 1992. Cited on page 357.
- 338** For information about the number  $\pi$ , and about some other mathematical constants, the website [oldweb.cecm.sfu.ca/pi/pi.html](http://oldweb.cecm.sfu.ca/pi/pi.html) provides the most extensive information and references. It also has a link to the many other sites on the topic, including the overview at [mathworld.wolfram.com/Pi.html](http://mathworld.wolfram.com/Pi.html). Simple formulae for  $\pi$  are

$$\pi + 3 = \sum_{n=1}^{\infty} \frac{n 2^n}{\binom{2n}{n}} \quad (150)$$

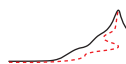
or the beautiful formula discovered in 1996 by Bailey, Borwein and Plouffe

$$\pi = \sum_{n=0}^{\infty} \frac{1}{16^n} \left( \frac{4}{8n+1} - \frac{2}{8n+4} - \frac{1}{8n+5} - \frac{1}{8n+6} \right). \quad (151)$$

The mentioned site also explains the newly discovered methods for calculating specific binary digits of  $\pi$  without having to calculate all the preceding ones. The known digits of  $\pi$  pass all tests of randomness, as the [mathworld.wolfram.com/PiDigits.html](http://mathworld.wolfram.com/PiDigits.html) website explains. However, this property, called *normality*, has never been proven; it is the biggest open question about  $\pi$ . It is possible that the theory of chaotic dynamics will lead to a solution of this puzzle in the coming years.

Another method to calculate  $\pi$  and other constants was discovered and published by D. V. CHUDNOVSKY & G. V. CHUDNOVSKY, The computation of classical constants, *Proceedings of the National Academy of Sciences (USA)* 86, pp. 8178–8182, 1989. The Chudnovsky brothers have built a supercomputer in Gregory's apartment for about 70 000 euros, and for many years held the record for calculating the largest number of digits of  $\pi$ . They have battled for decades with Kanada Yasumasa, who held the record in 2000, calculated on an industrial supercomputer. However, the record number of (consecutive) digits in 2010 was calculated in 123 days on a simple desktop PC by Fabrice Bellard, using a Chudnovsky formula. Bellard calculated over 2.7 million million digits, as told on [bellard.org](http://bellard.org). New formulae to calculate  $\pi$  are still occasionally discovered.

For the calculation of Euler's constant  $\gamma$  see also D. W. DE TEMPLE, A quicker convergence to Euler's constant, *The Mathematical Intelligencer*, pp. 468–470, May 1993. Cited on pages 332 and 359.





# CREDITS

## ACKNOWLEDGEMENTS

Many people who have kept their gift of curiosity alive have helped to make this project come true. Most of all, Saverio Pascazio has been – present or not – a constant reference for this project. Fernand Mayné, Anna Koolen, Ata Masafumi, Roberto Crespi, Serge Pahaut, Luca Bombelli, Herman Elswijk, Marcel Krijn, Marc de Jong, Martin van der Mark, Kim Jalink, my parents Peter and Isabella Schiller, Mike van Wijk, Renate Georgi, Paul Tegelaar, Barbara and Edgar Augel, M. Jamil, Ron Murdock, Carol Pritchard, Richard Hoffman, Stephan Schiller and, most of all, my wife Britta have all provided valuable advice and encouragement.

Many people have helped with the project and the collection of material. Most useful was the help of Mikael Johansson, Bruno Barberi Gnecco, Lothar Beyer, the numerous improvements by Bert Sierra, the detailed suggestions by Claudio Farinati, the many improvements by Eric Sheldon, the detailed suggestions by Andrew Young, the continuous help and advice of Jonatan Kelu, the corrections of Elmar Bartel, and in particular the extensive, passionate and conscientious help of Adrian Kubala.

Important material was provided by Bert Peeters, Anna Wierzbicka, William Beaty, Jim Carr, John Merrit, John Baez, Frank DiFilippo, Jonathan Scott, Jon Thaler, Luca Bombelli, Douglas Singleton, George McQuarry, Tilman Hausherr, Brian Oberquell, Peer Zalm, Martin van der Mark, Vladimir Surdin, Julia Simon, Antonio Fermani, Don Page, Stephen Haley, Peter Mayr, Allan Hayes, Norbert Dragon, Igor Ivanov, Doug Renselle, Wim de Muynck, Steve Carlip, Tom Bruce, Ryan Budney, Gary Ruben, Chris Hillman, Olivier Glassey, Jochen Greiner, squark, Martin Hardcastle, Mark Biggar, Pavel Kuzin, Douglas Brebner, Luciano Lombardi, Franco Bagnoli, Lukas Fabian Moser, Dejan Corovic, Paul Vannoni, John Haber, Saverio Pascazio, Klaus Finkenzeller, Leo Volin, Jeff Aronson, Roggie Boone, Lawrence Tuppen, Quentin David Jones, Arnaldo Uguzzoni, Frans van Nieuwpoort, Alan Mahoney, Britta Schiller, Petr Daneczek, Ingo Thies, Vitaliy Solomatin, Carl Offner, Nuno Proença, Elena Colazingari, Paula Henderson, Daniel Darre, Wolfgang Rankl, John Heumann, Joseph Kiss, Martha Weiss, Antonio González, Antonio Martos, André Slabber, Ferdinand Bautista, Zoltán Gácsi, Pat Furrie, Michael Reppisch, Enrico Pasi, Thomas Köppe, Martin Rivas, Herman Beeksma, Tom Helmond, John Brandes, Vlad Tarko, Nadia Murillo, Ciprian Dobra, Romano Perini, Harald van Lintel, Andrea Conti, François Belfort, Dirk Van de Moortel, Heinrich Neumaier, Jarosław Królikowski, John Dahlman, Fathi Namouni, Paul Townsend, Sergei Emelin, Freeman Dyson, S.R. Madhu Rao, David Parks, Jürgen Janek, Daniel Huber, Alfons Buchmann, William Purves, Pietro Redondi, Damoon Saghian, Frank Sweetser, plus a number of people who wanted to remain unnamed.

The software tools were refined with extensive help on fonts and typesetting by Michael Zedler and Achim Blumensath and with the repeated and valuable support of Donald Arseneau; help came also from Ulrike Fischer, Piet van Oostrum, Gerben Wierda, Klaus Böhncke, Craig Upright, Herbert Voss, Andrew Trevorrow, Danie Els, Heiko Oberdiek, Sebastian Rahtz, Don Story, Vincent Darley, Johan Linde, Joseph Hertzlinger, Rick Zacccone, John Warkentin, Ulrich Diez, Uwe



Siart, Will Robertson, Joseph Wright Enrico Gregorio, Rolf Niepraschk, Alexander Grahn and Werner Fabian.

All illustrations and animations in the text were made available by the copyright holders. A warm thank you to all of them. They are mentioned in the image and film credit sections. In particular, Lucas Barbosa and José Antonio Díaz Navas produced special animations for this text and Luca Gastaldi, Antonio Martos and Ulrich Kolberg produced special images for this text. The typesetting and book design is due to the professional consulting of Ulrich Dirr. The typography was improved with the help of Johannes Küster. The design of the book and its website owe also much to the suggestions and support of my wife Britta.

I also thank the lawmakers and the taxpayers in Germany, who, in contrast to most other countries in the world, allow residents to use the local university libraries.



Since May 2007, the electronic edition and distribution of the Motion Mountain text is generously supported by the Klaus Tschira Foundation.

### FILM CREDITS

The clear animation of a suspended spinning top, shown on [page 123](#), was made for this text by Lucas V. Barbosa. The beautiful animation of the planets and planetoids on [page 178](#) is copyright and courtesy by Hans-Christian Greier. It can be found on his wonderful website [www.parallax.at](http://www.parallax.at). The beautiful animation of the lunation on [page 155](#) was calculated from actual astronomical data and is copyright and courtesy by Martin Elsässer. It can be found on his website [www.mondatlas.de/lunation.html](http://www.mondatlas.de/lunation.html). The animation of refraction on [page 213](#) and of group velocity on [page 255](#) are copyright of the ISVR, University of Southampton, and courtesy of Steve Elliot. They can be found on the website [www.isvr.soton.ac.uk](http://www.isvr.soton.ac.uk). The film of an oscillating quartz on [page 236](#) is copyright and courtesy of Micro Crystal, part of the Swatch Group, found at [www.microcrystal.com](http://www.microcrystal.com). The films of solitons on [page 252](#) and of dromions on [page 261](#) are copyright and courtesy by Jarmo Hietarinta. They can be found on his website [users.utu.fi/hietarin](http://users.utu.fi/hietarin). The film of leapfrogging vortex rings on [page 284](#) is copyright and courtesy by Lim Tee Tai. It can be found via his fluid dynamics website [serve.me.nus.edu.sg](http://serve.me.nus.edu.sg). The film of the growing snowflake on [page 322](#) is copyright and courtesy by Kenneth Libbrecht. It can be found on his website [www.its.caltech.edu/~atomic/snowcrystals](http://www.its.caltech.edu/~atomic/snowcrystals).

### IMAGE CREDITS

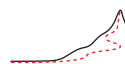
The photograph of a peak in the Himalaya on the front cover is courtesy and copyright by Dave Thompson and used to be on his website [www.daveontrek.co.uk](http://www.daveontrek.co.uk). The lightning photograph on [page 13](#) is courtesy and copyright by Harald Edens and found on the [www.lightningsafety.noaa.gov/photos.htm](http://www.lightningsafety.noaa.gov/photos.htm) and [www.weather-photography.com](http://www.weather-photography.com) websites. The motion illusion on [page 17](#) is courtesy and copyright by Michael Bach and found on his website [www.michaelbach.de/ot/mot\\_rotsnake/index.html](http://www.michaelbach.de/ot/mot_rotsnake/index.html). It is a variation of the illusion by Kitaoka Akiyoshi found on [www.ritsumei.ac.jp/~akitaoka](http://www.ritsumei.ac.jp/~akitaoka) and used here with his permission. The figures on [pages 19, 53 and 167](#) were made especially for this text and are copyright by Luca Gastaldi. The high speed photograph of a bouncing tennis ball on [page 18](#) is courtesy and copyright by the International Tennis Federation, and were provided by Janet Page. The figure of Etna on [pages 21 and 135](#) is copyright and courtesy of Marco Fulle and taken from the wonderful website [www.stromboli.net](http://www.stromboli.net). The famous photograph of the Les Poulains and its lighthouse by Philip Plisson on [page 22](#) is courtesy and copyright by Pêcheurs d'Images; see the websites [www.plisson.com](http://www.plisson.com) and [www.pecheurs-d-images.com](http://www.pecheurs-d-images.com). It is also found in Plisson's magnum opus *La Mer*, a stunning book of photographs of the sea. The picture on [page 22](#) of Alexander Tsukanov jumping from one ulti-

mate wheel to another is copyright and courtesy of the Moscow State Circus. The photograph of a deer on page 24 is copyright and courtesy of Tony Rodgers and taken from his website [www.flickr.com/photos/moonm](http://www.flickr.com/photos/moonm). The graph on page 36 is redrawn and translated from the wonderful book by HENK TENNEKES, *De wetten van de vliegkunst - Over stijgen, dalen, vliegen en zweven*, Aramith Uitgevers, 1993. The photographs of the ping-pong ball on page 38 and of the dripping water tap on page 274 are copyright and courtesy of Andrew Davidhazy and found on his website [www.rit.edu/~andpph](http://www.rit.edu/~andpph). The photograph of the bouncing water droplet on page 38 are copyright and courtesy of Max Groenendijk and found on the website [www.lightmotif.nl](http://www.lightmotif.nl). The photograph of the precision sundial on page 42 is copyright and courtesy of Stefan Pietrzik and found at [commons.wikimedia.org/wiki/Image:Präzissions-Sonnenuhr\\_mit\\_Sommerwalze.jpg](http://commons.wikimedia.org/wiki/Image:Präzissions-Sonnenuhr_mit_Sommerwalze.jpg). The graph on the scaling of biological rhythms on page 44 is courtesy and copyright of Enrique Morgado. The illustrations of the vernier caliper and the micrometer screw on page 50 and 59 are copyright of Medien Werkstatt, courtesy of Stephan Bogusch, and taken from their instruction course found on their website [www.medien-werkstatt.de](http://www.medien-werkstatt.de). The photo of the tiger on page 50 is copyright of Naples zoo (in Florida, not in Italy), and courtesy of Tim Tetzlaff; see their website at [www.napleszoo.com](http://www.napleszoo.com). The other length measurement devices on page 50 are courtesy and copyright of Keyence and Leica Geosystems, found at [www.leica-geosystems.com](http://www.leica-geosystems.com). The curvimeter photograph on page 51 is copyright and courtesy of Frank Müller and found on the [www.wikimedia.org](http://www.wikimedia.org) website. The crystal photograph on the left of page 54 is copyright and courtesy of Stephan Wolfsried and found on the [www.mindat.org](http://www.mindat.org) website. The crystal photograph on the right of page 54 is courtesy of Tullio Bernabei, copyright of Arch. Speleoresearch & Films/La Venta and found on the [www.laventa.it](http://www.laventa.it) and [www.naica.com.mx](http://www.naica.com.mx) websites. The hollow Earth figure on pages 56 and 259 is courtesy of Helmut Diel and was drawn by Isolde Diel. The wonderful photographs on page 64, page 128, page 142, page 158, page 172 and page 391 are courtesy and copyright by Anthony Ayiomamitis; the story of the photographs is told on his beautiful website at [www.perseus.gr](http://www.perseus.gr). The anticrepuscular photograph on page 65 is courtesy and copyright by Peggy Peterson. The image of the tight knot on page 66 is courtesy and copyright by Piotr Pieranski. The firing caterpillar figure of page 71 is courtesy and copyright of Stanley Caveney. The photograph of an airbag sensor on page 78 is courtesy and copyright of Bosch; the accelerometer picture is courtesy and copyright of Rieker Electronics; the three drawings of the human ear are copyright of Northwestern University and courtesy of Tim Hain and found on his website [www.dizziness-and-balance.com/disorders/bppv/otoliths.html](http://www.dizziness-and-balance.com/disorders/bppv/otoliths.html). The photograph of Orion on page 79 is courtesy and copyright by Matthew Spinelli. The photograph of *N. decemspinosa* on page 82 is courtesy and copyright of Robert Full, and found on his website [rjf9.biol.berkeley.edu/twiki/bin/view/PolyPEDAL/LabPhotographs](http://rjf9.biol.berkeley.edu/twiki/bin/view/PolyPEDAL/LabPhotographs). The photograph of *P. ruralis* on page 82 is courtesy and copyright of John Brackenbury, and part of his wonderful collection on the website [www.sciencephoto.co.uk](http://www.sciencephoto.co.uk). The millipede photograph on page 82 is courtesy and copyright of David Parks, and found on his website [www.mobot.org/mobot/madagascar/image.asp?relation=A71](http://www.mobot.org/mobot/madagascar/image.asp?relation=A71). The photograph of the Gekko climbing the bus window on page 82 is courtesy and copyright of Marcel Berendsen, and found on his website [www.flickr.com/photos/berendm](http://www.flickr.com/photos/berendm). The photograph of comet McNaught on page 83 is courtesy and copyright by its discoverer, Robert McNaught; it is taken from his website at [www.mso.anu.edu.au/~rmn](http://www.mso.anu.edu.au/~rmn) and is found also on [antwrp.gsfc.nasa.gov/apod/ap070122.html](http://antwrp.gsfc.nasa.gov/apod/ap070122.html). The photograph of the standard kilogram on page 88 is courtesy and copyright by the Bureau International des Poids et Mesures (BIPM). The photograph of Mendeleev's balance on page 94 is copyright of Thinktank Trust and courtesy of Jack Kirby; it can be found on the [www.birminghamstories.co.uk](http://www.birminghamstories.co.uk) website. The photograph of the laboratory scale on page 94 is copyright and courtesy of Mettler-Toledo. The measured graph of the walking human on page 106 is courtesy and copyright of Ray McCoy. The photograph of Foucault's gyroscope on page 119 is courtesy and copyright of the museum of the CNAM, the Conservatoire National des Arts et Métiers in

Paris, whose website is at [www.arts-et-metiers.net](http://www.arts-et-metiers.net). The photograph of the laser gyroscope on page 119 is courtesy and copyright of JAXA, the Japan Aerospace Exploration Agency, and found on their website at [jda.jaxa.jp](http://jda.jaxa.jp). The drawing of the precision laser gyroscope on page 120 is courtesy and copyright of the Bundesamt für Kartographie und Geodäsie. The photograph of the instrument is courtesy and copyright of Carl Zeiss. The machine is located at the Fundamentalstation Wettzell, and its website is found at [www.wettzell.ifag.de](http://www.wettzell.ifag.de). The graph of the temperature record on page 129 is copyright and courtesy Jean Jouzel and Science/AAAS. The sonoluminescence picture on page 84 is courtesy and copyright of Detlev Lohse. Figure 100 on page 136 is courtesy and copyright of the international Gemini project (Gemini Observatory/Association of Universities for Research in Astronomy) at [www.ausgo.unsw.edu.au](http://www.ausgo.unsw.edu.au) and [www.gemini.edu](http://www.gemini.edu). The photograph of the clock that needs no winding up is copyright Jaeger-LeCoultre and courtesy of Ralph Stieber. Its history and working are described in detail in a brochure available from the company. The company's website is [www.Jaeger-LeCoultre.com](http://www.Jaeger-LeCoultre.com). The basilisk running over water, page 138 and on the back cover, is courtesy and copyright by the Belgian group TERRA vzw and found on their website [www.terra.vzw.org](http://www.terra.vzw.org). The water strider photograph on page 138 is courtesy and copyright by Charles Lewallen. The photograph of the water robot on page 138 is courtesy and copyright by the American Institute of Physics. The photograph of the precision pendulum clock on page 144 is copyright of Erwin Sattler OHG, Sattler OHG, Erwin and courtesy of Ms. Stephanie Sattler-Rick; it can be found at the [www.erwinsattler.de](http://www.erwinsattler.de) website. The figure on the triangulation of the meridian of Paris on page 147 is copyright and courtesy of Ken Alder and found on his website [www.kenalder.com](http://www.kenalder.com). The photographs of the home version of the Cavendish experiment on page 148 are courtesy and copyright by John Walker and found on his website [www.fourmilab.ch/gravitation/foobar](http://www.fourmilab.ch/gravitation/foobar). The photographs of the precision Cavendish experiment on page 149 are courtesy and copyright of the Eöt-Wash Group at the University of Washington and found at [www.npl.washington.edu/eotwash](http://www.npl.washington.edu/eotwash). The geoid of page 151 is courtesy and copyright by the GFZ Potsdam, found at [www.gfz-potsdam.de](http://www.gfz-potsdam.de). The photograph of the Galilean satellites on page 153 is courtesy and copyright by Robin Scagell and taken from his website [www.galaxypix.com](http://www.galaxypix.com). The moon maps on page 156 are courtesy of the USGS Astrogeology Research Program, [astrogeology.usgs.gov](http://astrogeology.usgs.gov), in particular Mark Rosek and Trent Hare. The photograph of the tides on page 161 is copyright and courtesy of Gilles Régnier and found on his website [www.gillesregnier.com](http://www.gillesregnier.com); it also shows an animation of that tide over the whole day. The pictures of fast descents on snow on page 169 are copyright and courtesy of Simone Origone, [www.simoneorigone.it](http://www.simoneorigone.it), and of Éric Barone, [www.ericbarone.com](http://www.ericbarone.com). The pictures of solar eclipses on page 180 are courtesy and copyright by the Centre National d'Etudes Spatiales, at [www.cnes.fr](http://www.cnes.fr), and of Laurent Laveder, from his beautiful site at [www.PixHeaven.net](http://www.PixHeaven.net). The pictures of daisies on page 198 are copyright and courtesy of Giorgio Di Iorio, found on his website [www.flickr.com/photos/gioischia](http://www.flickr.com/photos/gioischia), and of Thomas Lüthi, found on his website [www.tiptom.ch/album/blumen/](http://www.tiptom.ch/album/blumen/). The photograph of fireworks in Chantilly on page 200 is courtesy and copyright of Christophe Blanc and taken from his beautiful website at [christopheblanc.free.fr](http://christopheblanc.free.fr). The figure of myosotis on page 216 is courtesy and copyright by Markku Savela. The image of the wallpaper groups on page 217 is copyright and courtesy of Dror Bar-Natan, and is taken from his fascinating website at [www.math.toronto.edu/~drorbn/Gallery](http://www.math.toronto.edu/~drorbn/Gallery). The images of solid symmetries on page 218 is copyright and courtesy of Jonathan Goss, and is taken from his website at [www.phys.ncl.ac.uk/staff.njpg/symmetry](http://www.phys.ncl.ac.uk/staff.njpg/symmetry). Also David Mermin and Neil Ashcroft have given their blessing to the use. The interference figures on page 242 are copyright and courtesy of Rüdiger Paschotta and found on his free laser encyclopedia at [www.rp-photonics.com](http://www.rp-photonics.com). The figure of the soliton in the water canal on page 251 is copyright and courtesy of Dugald Duncan and taken from his website at [www.ma.hw.ac.uk/solitons/soliton1.html](http://www.ma.hw.ac.uk/solitons/soliton1.html). The fractal mountain on page 264 is courtesy and copyright by Paul Martz, who explains on his website [www.gameprogrammer.com/fractal.html](http://www.gameprogrammer.com/fractal.html) how to program such images.

The photographs of silicon carbide on [page 269](#) are copyright and courtesy of Dietmar Siche. The photograph of an AFM on [page 271](#) is copyright of Nanosurf (see [www.nanosurf.ch](http://www.nanosurf.ch)) and used with kind permission of Robert Sum. The AFM image of silicon on [page 272](#) is copyright of the Universität Augsburg and is used by kind permission of German Hammerl. The figure of helium atoms on metal on [page 272](#) is copyright and courtesy of IBM. The photograph of a single barium ion on [page 273](#) is copyright and courtesy of Werner Neuhauser at the Universität Hamburg. The photographs of fluid motion on [page 274](#) are copyright and courtesy of John Bush, Massachusetts Institute of Technology, and taken from his web site [www-math.mit.edu/~bush](http://www-math.mit.edu/~bush). The photograph of the smoke ring at Etna on [page 284](#) is courtesy and copyright by Daniela Szczepanski and found at her extensive websites [www.vulkanarchiv.de](http://www.vulkanarchiv.de) and [www.vulkane.net](http://www.vulkane.net). The photograph of the Atomium on [page 288](#) is courtesy and copyright by the Asbl Atomium Vzw and used with their permission, in cooperation with SABAM in Belgium. Both the picture and the Atomium itself are under copyright. The photographs of the granular jet on [page 289](#) in sand are copyright and courtesy of Amy Shen, who discovered the phenomenon together with Sigurdur Thoroddsen. The photograph of the bucket-wheel excavator on [page 291](#) is copyright and courtesy of RWE and can be found on their website [www.rwe.com](http://www.rwe.com). The thermographic images of a braking bicycle on [page 293](#) are copyright Klaus-Peter Möllmann and Michael Vollmer, Fachhochschule Brandenburg/Germany, and courtesy of Michael Vollmer and Frank Pinno. The balloon photograph on [page 301](#) is copyright Johan de Jong and courtesy of the Dutch Balloon Register found at [www.dutchballoonregister.nl.ballonregister](http://www.dutchballoonregister.nl.ballonregister), nederlands The scanning tunnelling microscope picture of gold on [page 309](#) is courtesy of Sylvie Rousset and copyright by CNRS in France. The photographs and figure on [page 319](#) are copyright and courtesy of Ernesto Altshuler, Claro Noda and coworkers, and found on their website [www.complexperiments.net](http://www.complexperiments.net). The road corrugation photo is courtesy of David Mays and taken from his paper [Ref. 286](#). The oscillon picture on [page 321](#) is courtesy and copyright by Paul Umbanhowar. The drawing of swirled spheres on [page 321](#) is courtesy and copyright by Karsten Kötter. The pendulum fractal on [page 324](#) is courtesy and copyright by Paul Nylander and found on his website [bugman123.com](http://bugman123.com).

The fluid flowing over an inclined plate on [page 326](#) is courtesy and copyright by Vakhtang Putkaradze. The photograph of the Belousov-Zhabotinski reaction on [page 327](#) is courtesy and copyright of Yamaguchi University and found on their picture gallery at [www.sci.yamaguchi-u.ac.jp/sw/sw2006/](http://www.sci.yamaguchi-u.ac.jp/sw/sw2006/). The photographs of starch columns on [page 328](#) are copyright of Gerhard Müller (1940–2002), and are courtesy of Ingrid Hörnchen. The other photographs on the same page are courtesy and copyright of Raphael Kessler, from his website [www.raphaelk.co.uk](http://www.raphaelk.co.uk), of Bob Pohlrad, from his website [www.ferrum.edu/bpohlrad](http://www.ferrum.edu/bpohlrad), and of Cédric Hüslér. The photograph of a swarm of starlings on [page 330](#) is copyright and courtesy of Andrea Cavagna and Physics Today. The photograph of sunbeams on [page 368](#) is copyright and courtesy by Fritz Bieri and Heinz Rieder and found on their website [www.beatenbergbilder.ch](http://www.beatenbergbilder.ch). The drawing on [page 373](#) is courtesy and copyright of Daniel Hawkins. The photograph of a slide rule on [page 376](#) is courtesy and copyright of Jörn Lütjens, and found on his website [www.joernluetjens.de](http://www.joernluetjens.de). The photograph of the bursting soap bubble on [page 366](#) is copyright and courtesy by Peter Wienerroither and found on his website [homepage.univie.ac.at/Peter.Wienerroither](http://homepage.univie.ac.at/Peter.Wienerroither). The photograph on the back cover, of a basilisk running over water, is courtesy and copyright by the Belgian group TERRA vzw and found on their website [www.terra.vzw.org](http://www.terra.vzw.org). All drawings are copyright by Christoph Schiller. If you suspect that your copyright is not correctly given or obtained, this has not done on purpose; please contact me in this case.





# NAME INDEX

## A

ABE

### A

Abe, F. 409  
 Ackermann, Rudolph 373  
 Adachi, S. 421  
 Adelberger, E.G. 416  
 Adenauer, Konrad 166  
 Aetius 87, 412  
 Ahlgren, A. 408  
 Aigler, M. 53  
 AIP 138  
 Åkerman, N. 419  
 Alder, Ken 147, 416, 436  
 Alighieri, Dante 141  
 ALizad, A. 421  
 Alsdorf, D. 419  
 Altshuler, E. 428  
 Altshuler, Ernesto 319, 437  
 Amundsen, Roald 141, 416  
 An, K. 424  
 Anders, S. 417  
 Anderson, R. 414  
 Andreotti, B. 428  
 Angell, C.A. 423  
 Aniçin, I.V. 418  
 Anonymous 42, 198  
 Aquinas, Thomas 406  
 Archimedes  
   life 88  
 Aristarchos 413  
 Aristarchos of Samos 114, 125,  
   413  
 Aristotle 45, 143, 410  
   life 38  
 Armstrong, J.T. 411  
 Aronson, Jeff 433  
 Aronson, Jeff K. 431  
 Arseneau, Donald 433

Ashby, M.F. 423  
 Ashcroft, Neil 218, 436  
 Ashida, H. 405  
 ASML 289  
 Asterix 285  
 Ata Masafumi 433  
 Atomium 288  
 Atomium - SABAM 437  
 Au, W.W.L. 422  
 Audoin, C. 430  
 Augel, Barbara and Edgar 433  
 Ausloos, M. 422  
 Avogadro, Amadeo 271  
 Axelrod, R. 405  
 Ayiomamitis, Anthony 64,  
   128, 142, 158, 172, 391, 435

### B

Babinet, Jacques  
   life 348  
 Babloyantz, A. 428  
 Bach, Michael 17, 434  
 Bachelier, Louis 426  
 Baez, John 433  
 Bagnoli, Franco 433  
 Bahr, D.B. 422  
 Balibar, S. 423  
 ballonregister, nederlands 437  
 Banach, Stefan 53, 264  
   life 52  
 Banavar, J.R. 420  
 Bandler, R. 406  
 Bandler, Richard 193, 406  
 Bar-Natan, Dror 217, 436  
 Barber, B.P. 411  
 Barberini, Francesco 265  
 Barberi Gnecco, Bruno 433  
 Barbosa, Lucas 434  
 Barbosa, Lucas V. 123, 434  
 Barbour, Julian 409  
 Barone, Éric 169, 436  
 Bartel, Elmar 433  
 Bassler, K.E. 428  
 Batista-Leyva, A.J. 428  
 Batty, R.S. 422  
 Baudelaire, Charles  
   life 17  
 Bautista, Ferdinand 433  
 Beaty, William 433  
 Becker, J. 419  
 Beeksma, Herman 433  
 Behroozi, C.H. 408  
 Bekenstein, Jacob 316  
 Belfort, François 433  
 Bellard, Fabrice 432  
 Bellizzi, M.J. 416  
 Benka, S. 412  
 Bennet, C.L. 415  
 Bennet-Clark, H.C. 410  
 Bennett, C.H. 427  
 Bentley, W.A. 427  
 Benzenberg, Johann Friedrich  
   115  
 Berendsen, Marcel 82, 435  
 Bergquist, J. 431  
 Berman, D.H. 422  
 Bernabei, Tullio 435  
 Bernoulli, Daniel 301  
   life 273  
 Bernoulli, J. 342  
 Bernoulli, Johann 393  
 Bessel 124  
 Bessel, Friedrich Wilhelm  
   life 125



## B

## BEVIS

- Bevis, M. 419  
 Beyer, Lothar 433  
 Bielefeldt, H. 424  
 Bieri, Fritz 368, 437  
 Biggar, Mark 433  
 Bilger, H.R. 414  
 BIPM 88  
 Bird, D.J. 431  
 Bischoff, Bernard 430  
 Bizouard, C. 415  
 Bladerider International 276  
 Blagden, Charles 312  
 Blanc, Christophe 200, 436  
 Blumensath, Achim 433  
 Bocquet, Lydéric 397, 424  
 Bode, Johann Elert 177  
 Boethius 364  
 Bogusch, Stephan 435  
 Bohr, Niels 307  
 Boiti, M. 260, 422  
 Bolt, Usain 71  
 Boltzmann, L. 426  
 Boltzmann, Ludwig 205, 299  
     life 303  
 Bombelli, Luca 433  
 Boone, Roggie 433  
 Borel, Emile 311, 427  
 Borelli, G. 406  
 Born, Max 267  
 Bosch 78, 435  
 Bourbaki, N. 342  
 Bowden, F.P. 419  
 Bower, B. 421  
 Brackenbury, J. 411  
 Brackenbury, John 82, 435  
 Bradley, James 127  
     life 125  
 Braginsky, V.B. 418  
 Brahe, Tycho 141  
     life 141  
 Brahm, A. de  
     life 343  
 Brandes, John 433  
 Brantjes, R. 389  
 Brebner, Douglas 433  
 Brennan, Richard 406  
 Brenner, M.P. 411  
 Bright, William 429  
 Brillouin, L. 427  
 Brillouin, Léon 306  
 Brooks, Mel 297  
 Brouwer, Luitzen 47  
 Brown, J.H. 420  
 Brown, Robert 303  
 Browning, R.C. 422  
 Bruce, Tom 433  
 Brush, S. 414  
 Buchmann, Alfons 433  
 Bucka, H. 414  
 Bucka, Hans 121  
 Buckley, Michael 405  
 Budney, Ryan 433  
 Bújovtsev, B.B. 405  
 Bundesamt für Kartographie  
     und Geodäsie 120, 436  
 Bunn, E.F. 429  
 Bunyan, Paul 423  
 Buridan, Jean 143, 416  
 Burša, Milan 410  
 Busche, Detlev 408  
 Bush, J.W.M. 424  
 Bush, John 274, 437  
 Böhncke, Klaus 433
- C**  
 Caesar 281  
 Caizergues, Alex 34  
 Cajori, Florian 430  
 Caldwell, R. 411  
 Caldwell, R.L. 411  
 Calzadilla, A. 420  
 Campbell, D. 427  
 Campbell, D.K. 428  
 Caps, H. 425  
 Carl Zeiss 120, 436  
 Carlip, Steve 433  
 Carlyle, Thomas  
     life 107  
 Carnot, Sadi  
     life 99  
 Carr, Jim 433  
 Carroll, Lewis, or Charles  
     Lutwidge Dogson 307  
 Cartesius  
     life 48  
 Casati, Roberto 411  
 Cassius Dio 178  
 Cauchy, Augustin-Louis 221  
 Cavagna, Andrea 330, 437  
 Cavendish, Henry  
     life 146  
 Caveney, S. 410  
 Caveney, Stanley 71, 435  
 Cayley, Arthur 221  
 Ceasar, Gaius Julius 343  
 Celsius, Anders  
     life 351  
 Chaineux, J. 430  
 Chan, M.A. 414  
 Chandler, Seth 124  
 Chao, B.F. 414  
 Charlemagne 343  
 Childs, J.J. 424  
 Chomsky, Noam 408  
 Christlieb, N. 418  
 Christou, A.A. 417  
 Chudnovsky, D.V. 432  
 Chudnovsky, G.V. 432  
 Clancy, Tom 422  
 Clanet, Christophe 397  
 Clarke, S. 407  
 Clausius, Rudolph 303  
     life 297  
 Clavius, Christophonius  
     life 60  
 Cleobulus  
     life 48  
 CNAM 119, 435  
 CNES 180  
 CNRS 309, 437  
 Cohen-Tannoudji, G. 427  
 Cohen-Tannoudji, Gilles 307  
 Colazingari, Elena 433  
 Coleman-McGhee, Jerdome  
     424  
 Colladon, Daniel 281  
 Collins, J.J. 406  
 Compton, A.H. 414  
 Compton, Arthur 118  
 Conkling, J.A. 410  
 Conservatoire National des  
     Arts et Métiers 435  
 Conti, Andrea 433  
 Coolquip 316  
 Cooper, Heather 416  
 Cooper, John N. 405  
 Coriolis, Gustave-Gaspard 116



# C

---

CORNELL

life 97  
 Cornell, E.A. 408  
 Corovic, Dejan 433  
 Costabel, Pierre 265  
 Coyne, G. 423  
 Coyne, George 423  
 Craven, J.D. 418  
 Crespi, Roberto 433  
 Cross, R. 378  
 Crutchfield, J. 427  
 Crystal, David 429

## D

Dahlman, John 433  
 Danecek, Petr 433  
 Dante Alighieri 141  
 Darius, J. 412  
 Darley, Vincent 433  
 Darre, Daniel 433  
 Dasari, R.R. 424  
 Davidhazy, Andrew 38, 259,  
 274, 435  
 Davidovich, Lev 345  
 Davis, S.D. 423  
 Deaver, B.S. 432  
 Deconinck, Bernard 261  
 Dehant, V. 415  
 Dehmelt, H. 424  
 Dehmelt, Hans 423  
 Dehn, Max  
 life 53  
 Demko, T.M. 414  
 Democritus 269, 345  
 life 270  
 Descartes, R. 342  
 Descartes, René 376  
 life 48  
 Destexhe, A. 428  
 DeTemple, D.W. 432  
 Deutschmann, Matthias 364  
 Dewdney, Alexander 66  
 Dicke, R.H. 418  
 Diehl, Helmut 56  
 Diel, Helmut 435  
 Diel, Isolde 435  
 Diez, Ulrich 433  
 DiFilippo, Frank 433  
 Dill, L.M. 422  
 Dio, Cassius 419

Dirac, Paul 233, 342  
 Dirr, Ulrich 434  
 Dixon, Bernard 409  
 Di Iorio, Giorgio 198, 436  
 Dobra, Ciprian 433  
 Doorne, C.W.H. van 428  
 Dorbolo, S. 425  
 Dorbolo, Stéphane 283  
 Douady, S. 428  
 Dougherty, R. 409  
 Doyle, Arthur Conan 263  
 Dragon, Norbert 433  
 Drake, Stillman 410  
 Dreybrodt, W. 428  
 Dubelaar, N. 389  
 Dubrulle, B. 418  
 Dumont, Jean-Paul 405, 412,  
 429  
 Duncan, Dugald 251, 436  
 Durben, D.J. 423  
 Durieux, M. 425  
 Dusenbery, David 411  
 Dutton, Z. 408  
 Dyson, Freeman 433  
 Díaz Navas, José Antonio 434

## E

Earls, K. 411  
 Earman, John 409  
 Eckhardt, B. 428  
 Eddington, Arthur  
 life 95  
 Edelman, H. 418  
 Edens, Harald 434  
 Edwards, B.F. 383  
 effect, Kaye 284  
 Einstein, A. 426  
 Einstein, Albert 16, 160, 163,  
 164, 206, 225, 227, 233, 303  
 Ekman, Walfrid  
 life 413  
 Ellerbroek, L. 422  
 Elliot, Steve 434  
 Els, Danie 433  
 Elsevier, Louis 368  
 Elswijk, H.B. 424  
 Elswijk, Herman B. 433  
 Elsässer, Martin 155, 434  
 Emelin, Sergei 433

Emerson, Ralph Waldo 253  
 Emsley, John 427  
 Engelmann, Wolfgang 408  
 Engels, Friedrich 191  
 Engemann, S. 425  
 Enquist, B.J. 420  
 Enss, Christian 426  
 Eötvös, R. von 417  
 Erdős, Paul 53  
 Eriksen, H.K. 410  
 Erwin Sattler OHG 144, 436  
 Euclid 33  
 Eukleides 33  
 Euler, L. 342  
 Euler, Leonhard 124, 179, 413  
 life 183  
 Evans, J. 418  
 Everitt, C.W. 432  
 Eöt-Wash Group 149, 436  
 Eötvös, Roland von 118

## F

Fabian, Werner 434  
 Fairbanks, J.D. 432  
 Faisst, H. 428  
 Falk, G. 417  
 Falkovich, G. 424  
 Fantoli, Annibale 423  
 Farinati, Claudio 433  
 Farmer, J. 427  
 Farrant, Penelope 412  
 Fatemi, M. 421  
 Fatio de Duillier, Nicolas 176  
 Fatio de Duillier, Nicolas 418  
 Faybishenko, B.A. 428  
 Fayeulle, Serge 419  
 Feder, T. 429  
 Fehr, C. 420  
 Fekete, E. 417  
 Feld, M.S. 424  
 Fermani, Antonio 433  
 Fernandez-Nieves, A. 415  
 Fibonacci, Leonardo 345  
 life 340  
 Figueroa, D. 420  
 Filippov, T. 422  
 Fink, Hans-Werner 424  
 Finkenzeller, Klaus 433  
 Firpić, D.K. 418

# F

---

FISCHER

- Fischer, Ulrike 433  
 Flach, S. 428  
 Flachsel, Erwein 405  
 Flindt, Rainer 408  
 Fokas, A.S. 261, 422  
 Foreman, M. 409  
 Forsberg, B. 419  
 Fortes, L.P. 419  
 Foster, James 420  
 Foucault, Jean Bernard Léon  
   life 117  
 Franklin, Benjamin 264  
 Frenzel 84  
 Fresnel, Augustin 243  
 Friedman, David 182  
 Fritsch, G. 422  
 Frova, Andrea 410  
 Full, R. 411  
 Full, Robert 82, 435  
 Fulle, Marco 21, 434  
 Fumagalli, Giuseppe 412, 419  
 Fundamentalstation Wettzell  
   436  
 Furrie, Pat 433
- G**
- Galilei, Galileo 41, 63, 68, 69,  
   114, 130, 146, 165, 168, 169,  
   267, 269, 368, 379  
   life 32, 265  
 Galileo 114, 345  
 Galois, Evariste 221  
 Gardner, Martin 376  
 Garrett, A. 412  
 Gaspard, Pierre 304, 426  
 Gastaldi, Luca 19, 53, 167, 434  
 Gauthier, N. 421  
 Gelb, M. 406  
 Gemini Observatory/AURA  
   136  
 General Electric 248  
 Geng, Tao 214  
 GeoForschungsZentrum  
   Potsdam 151  
 Georgi, Renate 433  
 Ghahramani, Z. 420  
 Ghavimi-Alagha, B. 416  
 Giessibl, F.J. 424  
 Gilligan, James 419
- Glasse, Olivier 433  
 Gold, Tommy 242  
 Goldstein, Herbert 420  
 Goles, E. 428  
 Golubitsky, M. 406  
 González, Antonio 433  
 Gooch, Van 43  
 Goriely, A. 425  
 Goss, Jonathan 218, 436  
 Gracovetsky, Serge 106, 412  
 Grahn, Alexander 434  
 Graner, F. 418  
 Graw, K.-U. 396  
 Gray, C.G. 383, 420  
 Greenleaf, J.F. 421  
 Greenside, Henry 362  
 Gregorio, Enrico 434  
 Greier, Hans-Christian 178,  
   434  
 Greiner, Jochen 433  
 Grimaldi, Francesco 254  
 Grinder, John 193, 406  
 Groenendijk, Max 38, 435  
 Gross, R.S. 415  
 Grossmann, A. 422  
 Grünbaum, Branko 421  
 Guglielmini,  
   Giovanni Battista 114  
 Guillén, Antonio 82  
 Gutierrez, G. 420  
 Gácsi, Zoltán 433  
 Günther, B. 408
- H**
- Haandel, M. van 417  
 Haber, John 433  
 Hagen, J.G. 414  
 Hagen, John 118  
 Haigneré, Jean-Pierre 180  
 Hain, Tim 435  
 Hakonen, P.J. 431  
 Halberg, F. 408  
 Haley, Stephen 433  
 Halley, Edmund 157  
 Halliday, David 424  
 Halliwell, J.J. 408  
 Hamilton, William 342  
 Hammerl, German 437  
 Hancock, M.J. 424
- Hardcastle, Martin 433  
 Hardy, Godfrey H.  
   life 155  
 Hare, Trent 436  
 Harriot, T. 342  
 Harris, S.E. 408  
 Hartman, W.K. 417  
 Hasha, A.E. 424  
 Hausherr, Tilman 433  
 Hawkins, Daniel 60, 372, 373,  
   437  
 Hayes, Allan 433  
 Hays, J.D. 415  
 Heath, Thomas 413  
 Heber, U. 418  
 Heckel, B.R. 416  
 Heckman, G. 417  
 Hediger, Heini 410  
 Heisenberg, Werner 215, 275,  
   307, 421  
 Helden, A. van 416  
 Heller, Carlo 42  
 Heller, E. 422  
 Hellinger, Bert 419  
 Helmholtz, Hermann von 99  
   life 296  
 Helmond, Tom 433  
 Helmont, Johan Baptista van  
   301  
 Hembacher, S. 424  
 Henbest, Nigel 416  
 Henderson, D.W. 420  
 Henderson, Paula 433  
 Henk Tennekes 36  
 Henon, M. 419  
 Henson, Matthew 387  
 Hentig, Hartmut von 7  
 Heraclitus  
   life 16  
 Heraclitus of Ephesus 25, 216  
 Herbert, Wally 416  
 Hermann, Jakob 388  
 Heron of Alexandria 280  
 Herrmann, F. 425  
 Herrmann, Friedrich 404  
 Herschel, William 128  
 Hertz, H.G. 412  
 Hertz, Heinrich 205  
 Hertz, Heinrich Rudolf

# H

## HERTZLINGER

- life 189  
 Hertzlinger, Joseph 433  
 Hestenes, D. 419  
 Heumann, John 433  
 Hewett, J.A. 416  
 Hietarinta, J. 422  
 Hietarinta, Jarmo 252, 261, 434  
 Higashi, R. 431  
 Hilbert, David 206, 227  
 Hilgenfeldt, S. 411  
 Hillman, Chris 433  
 Hipparchos 122  
 Hirano, M. 419  
 Hirota, R. 261, 422  
 Hodges, L. 418  
 Hodgkin, A.L. 250, 421  
 Hoehner, Sebastian 425  
 Hof, B. 428  
 Hohenstatt, M. 423  
 Holbrook, N.M. 423  
 Hollander, E. 424  
 Hong, F.-L. 431  
 Hooke 155  
 Hooke, Robert 234  
   life 142  
 Horace, in full Quintus  
   Horatius Flaccus 190  
 Hosoi, A.E. 424  
 Huber, Daniel 433  
 Hudson, R.P. 425  
 Humphreys, R. 415  
 Humphreys, W.J. 427  
 Hunklinger, Siegfried 426  
 Hunter, D.J. 411  
 Huxley, A.F. 250, 421  
 Huygens, Christiaan 143, 144, 244  
   life 90  
 Hörnchen, Ingrid 437  
 Hüsler, Cédric 328, 437
- I**  
 IBM 272  
 Ifrah, Georges 429  
 Illich, Ivan 361  
   life 360  
 Imae, Y. 411  
 Imbrie, J. 415
- Ingenhouz, Jan 302  
 Ingram, Jay 422  
 INMS 42  
 Inquisition 266  
 International Tennis  
   Federation 18, 434  
 IPCC 398  
 ISTA 293  
 ISVR, University of  
   Southampton 213, 255, 434  
 Ivanov, Igor 433  
 Ivry, R.B. 408
- J**  
 Jacobi, Carl 206  
 Jaeger-LeCoultre 112, 436  
 Jahn, O. 421  
 Jalink, Kim 433  
 James, M.C. 418  
 Jamil, M. 433  
 Jammer, M. 416  
 Janek, Jürgen 433  
 Japan Aerospace Exploration  
   Agency 436  
 JAXA 119, 436  
 Jeffreys, Harold 120  
 Jen, E. 427  
 Jennings, G.M. 423  
 Jensen, Hans 429  
 Jesus 281  
 Job, Georg 404  
 Johansson, Mikael 433  
 John Paul II 266  
 Johnson, Ben 410  
 Johnson, Michael 71  
 Johnson, Samuel 336, 360  
 Johnston, K.J. 411  
 Jones, Gareth 431  
 Jones, H. 342  
 Jones, Quentin David 433  
 Jones, Tony 431  
 Jong, Johan de 301, 437  
 Jong, Marc de 433  
 Joule, James 296  
 Joule, James P. 99  
 Joule, James Prescott  
   life 296  
 Joutel, F. 417
- Jouzel, J. 415  
 Jouzel, Jean 129, 436  
 Jürgens, H. 324  
 Jürgens, Hartmut 409
- K**  
 Köppe, Thomas 433  
 Kadanoff, L.P. 428  
 Kamiya, K. 394  
 Kanada Yasumasa 432  
 Kanecko, R. 419  
 Kant, Immanuel 164  
 Kantor, Yakov 362  
 Karl, G. 383, 420  
 Karstädt, D. 425, 426  
 Katori, H. 431  
 Kawagishi, I. 411  
 Keesing, R.G. 407, 431  
 Kelu, Jonatan 433  
 Kelvin, William  
   life 296  
 Kemp, David 242  
 Kempf, Jürgen 408  
 Kenderdine, M.A. 412  
 Kendrick, E. 419  
 Kepler 155  
 Kepler, Johannes 152, 153  
   life 141  
 Kerswell, R. 428  
 Kessler, Raphael 328, 437  
 Keyence 50, 435  
 Khallikan, Ibn  
   life 366  
 Kirby, Jack 435  
 Kirchhoff, Gustav 244  
 Kiss, Joseph 433  
 Kistler 281  
 Kistler, S.F. 424  
 Kitaoka Akiyoshi 15, 17, 405, 434  
 Kitaoka, A. 405  
 Kitaoka, Akiyoshi 405  
 Kivshar, Y.S. 428  
 Klaus Tschira Foundation 434  
 Koblenz, Fachhochschule 33  
 Koch, G.W. 423  
 Kolberg, Ulrich 434  
 Kooijman, J.D.G. 379  
 Koolen, Anna 433

# K

---

KOOMANS

- Koomans, A.A. 424  
 Korteweg 251  
 Krehl, P. 425  
 Krehl, Peter 287  
 Krijn, Marcel 433  
 Kristiansen, J.R. 410  
 Krivchenkov, V.D. 405  
 Krotkow, R. 418  
 Kruskal, M.D. 422  
 Kruskal, Martin 252  
 Królikowski, Jarosław 433  
 Kubala, Adrian 433  
 Kudo, S. 411  
 Kumar, K.V. 410  
 Kurths, Jürgen 417  
 Kuzin, Pavel 433  
 Kvale, E.P. 414  
 Kötter, K. 428  
 Kötter, Karsten 321, 437  
 Küster, Johannes 434  
 Küstner, Friedrich 415  
   life 124
- L**
- La Caille 143  
 Lagrange 211  
 Lagrange, Joseph Louis 202  
 Lagrangia,  
   Giuseppe Lodovico  
   life 202  
 Lalande 143  
 Lambeck, K. 414  
 Lambert, S.B. 415  
 Lancaster, George 420  
 Landau, Lev 345  
 Landauer, R. 427  
 Lang, H. de 427  
 Lang, K.R. 80  
 Langangen, Ø. 410  
 Laplace, Pierre Simon  
   life 159  
 Larsen, J. 415  
 Laskar, J. 418  
 Laskar, Jacques 177  
 Laskkar, J. 417  
 Laveder, Laurent 180, 436  
 Lavenda, B. 427  
 Lavoisier, Antoine-Laurent  
   life 89
- Laws, Kenneth 429  
 Lecar, M. 419  
 Lee, S.J. 415  
 Lega, Joceline 428  
 Legendre, A. 342  
 Lehmann, Paul 343, 430  
 Leibniz 96, 155, 199, 206  
 Leibniz, G. 342  
 Leibniz, Gottfried 202  
 Leibniz, Gottfried Wilhelm  
   407  
 Leibniz, Gottfried Wilhelm  
   life 75  
 Leica Geosystems 50, 435  
 Leidenfrost, Johann Gottlieb  
   282  
 Lennard, J. 343  
 Lennerz, C. 385  
 Leon, J.-P. 260, 422  
 Leonardo of Pisa  
   life 340  
 Lesage, G.-L. 418  
 Lesage, Georges-Louis 176  
 Leucippus of Elea  
   life 270  
 Leutwyler, K. 421  
 Lewallen, Charles 138, 436  
 Le Verrier, Urbain 160  
 Libbrecht, Kenneth 322, 434  
 Lichtenberg, Georg Christoph  
   life 32  
 Lim Tee Tai 284, 434  
 Lim, T.T. 425  
 Linde, Johan 433  
 Lintel, Harald van 433  
 Lissauer, J.J. 429  
 Liu, C. 408  
 Llobera, M. 412  
 Lloyd, Seth 426  
 Lockwood, E.H. 421  
 Lodge, Oliver  
   life 120  
 Lohse, D. 411  
 Lohse, Detlev 84, 436  
 Lombardi, Luciano 433  
 Loschmidt, Joseph  
   life 264  
 Luca Bombelli 433  
 Lucretius 271  
   life 38
- Lucretius Carus, Titus 38, 271  
 Luke, Lucky 285  
 Lévy-Leblond, Jean-Marc 105,  
   176, 404  
 Lüders, Klaus 404  
 Lüthi, Thomas 198, 436  
 Lütjens, Jörn 376, 437
- M**
- MacDonald, G.J.F. 414  
 MacDougall, Duncan 412, 413  
 MacDougalls, Duncan 107  
 Mach, Ernst  
   life 91  
 Macmillan, R.H. 421  
 Maekawa, Y. 411  
 Magariyama, Y. 411  
 Mahoney, Alan 433  
 Mahrl, M. 428  
 Maiorca, Enzo 424  
 Malin, D. 80  
 Mallat, Stéphane 422  
 Malley, R. 419  
 Mandelbrot, Benoît 51, 263  
 Mandelstam, Stanley 420  
 Mannhart, J. 424  
 Manogg, P. 422  
 Marcus, Richard 406  
 Marcus, Ron 294  
 Marcy, Geoffrey 157  
 Maris, H. 423  
 Mark, Martin van der 313, 433  
 Markus, M. 428  
 Marsaglia, G. 419  
 Martikainen, J.E. 431  
 Martin, A. 420  
 Martina, L. 260, 422  
 Martos, Antonio 433, 434  
 Martz, Paul 264, 436  
 Martínez, E. 428  
 Marx, Groucho 337  
 Masudi, Ibn 367  
 Matthews, R. 418  
 Maupertuis, Pierre Louis  
   Moreau de  
   life 114  
 Mayer, Julius Robert 99  
   life 296

## M

## MAYNARD

- Maynard, Finian 34  
 Mayné, Fernand 433  
 Mayr, Peter 433  
 Mays, D.C. 428  
 Mays, David 320, 437  
 McCoy, Ray 106, 435  
 McElwaine, J.N. 428  
 McLaughlin, William 405  
 McLean, H. 410  
 McMahob, T.A. 423  
 McMillen, T. 425  
 McNaught, Robert 83, 435  
 McQuarry, George 433  
 Medenbach, Olaf 409  
 Medien Werkstatt 435  
 Meijaard, J.P. 379  
 Melo, F. 428  
 Mendeleyev,  
     Dmitriy Ivanovich 94  
 Mendoza, E. 428  
 Merckx, Eddy 100  
 Mermin, David 218, 436  
 Merrit, John 433  
 Mertens, K. 428  
 Mettler-Toledo 94, 435  
 Mettrie, J. Offrey de la 325  
 Miákišev, G.Ya. 405  
 Michaelson, P.F. 432  
 Michel, Stanislav 96  
 Michelangelo 345  
 Michell, John  
     life 146  
 Micro Crystal 434  
 Microcrystal 236  
 Mikkola, Seppo 417  
 Milankovitch, Milutin  
     life 127  
 Mineyev, A. 423  
 Mirabel, I.F. 408  
 Mirsky, S. 377  
 Mohazzabi, P. 418  
 Mohr, P.J. 431  
 Mole, R. 421  
 Monitz, E.J. 412  
 Moore, J.A. 420  
 Moortel, Dirk Van de 433  
     Pierre Louis  
     life 114  
 Moreira, N. 420  
 Morgado, E. 408  
 Morgado, Enrique 44, 435  
 Morlet, J. 422  
 Morris, S.W. 428  
 Moscow State Circus 22, 435  
 Moser, Lukas Fabian 433  
 Mozurkewich, D. 411  
 Muller, R.A. 422  
 Mulligan, J.F. 412  
 Munk, W.H. 414  
 Muramoto, K. 411  
 Murata, Y. 419  
 Murdock, Ron 433  
 Mureika, J.R. 419  
 Murillo, Nadia 433  
 Murphy, R. 342  
 Murray, C.D. 417  
 Muskens, O. 422  
 Muynck, Wim de 433  
 Måløy, K.J. 428  
 Möllmann, K.-P. 425, 426  
 Möllmann, Klaus-Peter 293,  
     437  
 Müller, Frank 51, 435  
 Müller, G. 428  
 Müller, Gerhard 327, 328  
     life 437  
**N**  
 Namba, K. 411  
 Namouni, F. 417  
 Namouni, Fathi 433  
 Nanosurf 271  
 Nansen, Fridtjof 413  
 Napiwotzki, R. 418  
 Naples zoo 50, 435  
 Napoleon 160  
 NASA 42, 398  
 Nassau, K. 86  
 Nauenberg, M. 416  
 Navier, Claude  
     life 275  
 Needham, Joseph 420  
 Nelson, A.E. 416  
 Neuhauser, W. 423  
 Neuhauser, Werner 273, 437  
 Neumaier, Heinrich 433  
 Neumann, Dietrich 156, 417  
 Newcomb, Simon 160, 417  
 Newton 155, 352, 407  
 Newton, Isaac 45, 114, 142  
     life 32  
 Nicolis, Grégoire 426  
 Niederer, U. 226, 421  
 Niepraschk, Rolf 434  
 Nieuwpoort, Frans van 433  
 Nieuwstadt, F.T.M. 428  
 Nieves, F.J. de las 415  
 Nightingale, J.D. 420  
 Nitsch, Herbert 277  
 Nobel, P. 423  
 Noda, Claro 437  
 Noether, Emmy  
     life 227  
 Nolte, John 406  
 Nonnius, Peter  
     life 60  
 Norfleet, W.T. 410  
 Northwestern University 46,  
     78, 257, 435  
 Novikov, V.A. 383, 420  
 Nuñez, Pedro  
     life 60  
 Nylander, Paul 324, 437  
**O**  
 O'Keefe, R. 416  
 Oberdiek, Heiko 433  
 Oberquell, Brian 433  
 Offner, Carl 433  
 Offrey de la Mettrie, J. 325  
 Ogburn, P.L. 421  
 Oostrum, Piet van 433  
 Oppenheimer, Robert 208  
 Origone, Simone 169, 436  
 Oughtred, W. 342  
**P**  
 Page, Don 433  
 Page, Janet 434  
 Pahaut, Serge 433  
 Pais, A. 421  
 Panov, V.I. 418  
 Papadopoulos, J.M. 379  
 Pappus 88  
 Park, David 404  
 Parks, David 82, 433, 435

# P

---

PARLETT

- Parlett, Beresford 23  
 Parmenides 16, 76  
 Parmenides of Elea 16  
 Pascazio, Saverio 433  
 Paschotta, Rüdiger 242, 436  
 Pasi, Enrico 433  
 Paul, T. 422  
 Pauli, Wolfgang 388  
 Peano, G. 342  
 Peary, Robert 141, 386, 416  
 Pěč, Karel 410  
 Pedley, T.J. 410  
 Peeters, Bert 433  
 Peitgen, H.-O. 324  
 Peitgen, Heinz-Otto 409  
 Pekár, V. 417  
 Pelizzari, Umberto 424  
 Pempinelli, F. 260, 422  
 Perc, M. 412  
 Perelman, Yakov 256, 404  
 Perini, Romano 433  
 Perrin, J. 426  
 Perrin, Jean 400, 426  
   life 304  
 Peterson, Peggy 65, 435  
 Petit, Jean-Pierre 363  
 Pfeffer, W.T. 422  
 Phillips, R.J. 417  
 Physics Today 330, 437  
 Piaget, Jean 406  
 Piccard, Auguste  
   life 281  
 Pieranski, P. 409  
 Pieranski, Piotr 66, 435  
 Pietrzik, Stefan 391, 435  
 Pikler, Emmi 406  
 Pikovsky, Arkady 417  
 Pinker, Steven 408  
 Pinno, F. 425, 426  
 Pinno, Frank 437  
 PixHeaven.net 180  
 Planck, Max 303, 305  
 Plato 331  
   life 270  
 Plinius, in full Gaius Plinius  
   Secundus 404  
 Plisson, Philip 22, 434  
 Plutarchus 194  
 Pohl, Robert 404  
 Pohl, Robert O. 404  
 Pohlrad, Bob 328, 437  
 Poincaré, Henri 130  
 Poinsoot, Louis 118  
 Poisson, Siméon-Denis  
   life 150  
 Polster, B. 426  
 Pompeius, Gnaeus 194  
 Preston-Thomas, H. 426  
 Price, R.H. 93  
 Prigogine, Ilya 292, 327  
 Pritchard, Carol 433  
 Proença, Nuno 433  
 Protagoras 351  
 Przybyl, S. 409  
 Ptolemy 63  
 Purves, William 433  
 Putkaradze, V. 428  
 Putkaradze, Vakhtang 326,  
   437  
 Putterman, S.J. 411  
 Pythagoras 253  
 Päsler, Max 420  
 Pérez-Mercader, J. 408  
 Pérez-Penichet, C. 428
- Q**  
 Quinlan, G.D. 418
- R**  
 Rahtz, Sebastian 433  
 Ramanujan, Srinivasa 155  
 Ramos, O. 428  
 Randi, James 21  
 Rankl, Wolfgang 433  
 Rawlins, D. 416  
 Raymond, David 362  
 Rechenberg, Ingo 411  
 Recorde, R. 342  
 Recorde, Robert  
   life 341  
 Redondi, Pietro 32, 265, 433  
 Rees, W.G. 404  
 Regiomontanus, J. 342  
 Reichl, Linda 425, 427  
 Reimers, D. 418  
 Renselle, Doug 433  
 Reppisch, Michael 433  
 Resnick, Robert 424  
 Richardson, Lewis Fray  
   life 49  
 Rickwood, P.C. 409  
 Rieder, Heinz 368, 437  
 Rieflin, E. 411  
 Rieker Electronics 78, 435  
 Rinaldo, A. 420  
 Rindt, Jochen  
   life 33  
 Rivas, Martin 433  
 Rivera, A. 428  
 Robertson, Will 434  
 Robutel, P. 417  
 Rodgers, Tony 24, 435  
 Rodin, Auguste 144  
 Rodríguez, L.F. 408  
 Rohrbach, Klaus 415  
 Roll, P.G. 418  
 Romer, R.H. 392  
 Rosek, Mark 436  
 Rosenblum, Michael 417  
 Rousset, Sylvie 437  
 Ruben, Gary 433  
 Rudolff, C. 342  
 Rudolff, Christoff 430  
 Ruffini, Remo 429  
 Ruga, Spurius Carvilius 337  
 Ruina, A. 379  
 Ruppel, W. 417  
 Rusby, R.L. 425, 431  
 Rusby, Richard 431  
 Russel, J.S. 422  
 Russel, Mark 180  
 Russell, Bertrand 204  
 Russell, John Scott  
   life 250  
 Russo, Lucio 404  
 Rutherford, Ernest 23  
 RWE 291, 437  
 Régnier, Gilles 161, 436
- S**  
 S.R. Madhu Rao 433  
 SABAM 288  
 Sade, Donatien de 189  
 Saghian, Damoon 433  
 Sagnac, Georges  
   life 118  
 Sanctorius



# S

---

SANDS

- life 92  
 Sands, Matthew 404  
 Santini, P.M. 261, 422  
 Santorio Santorio  
   life 92  
 Saráeva, I.M. 405  
 Sattler OHG, Erwin 436  
 Sattler-Rick, Stephanie 436  
 Sauer, J. 385  
 Sauerbruch, Ferdinand 397  
 Saupe, D. 324  
 Saupe, Dietmar 409  
 Savela, Markku 216, 436  
 Scagell, Robin 153, 436  
 Schiller, Britta 433, 434  
 Schiller, C. 424  
 Schiller, Christoph 222, 437  
 Schiller, Isabella 433  
 Schiller, Peter 433  
 Schiller, Stephan 433  
 Schlichting, H.-J. 386  
 Schmidt, Klaus T. 411  
 Schmidt, T. 428  
 Schmidt-Nielsen, K. 427  
 Schneider, Jean 420  
 Schneider, Wolf 430  
 Schooley, J.F. 425  
 Schulte 84  
 Schwab, A.L. 379  
 Schwab, Arend 380  
 Schwartz, Richard 406  
 Schwenk, K. 427  
 Schwenkel, D. 425  
 Schönenberger, C. 424  
 Schörner, E. 385  
 Science 129  
 Science Photo Library 82  
 Science/AAAS 436  
 Scime, E.E. 383  
 Scott, Jonathan 433  
 Scriven 281  
 Scriven, L.E. 424  
 Segrè, Gino 425  
 Settles, Gary 259  
 Sexl, Roman  
   life 55  
 Shackleton, N.J. 415  
 Shakespeare, William 21  
 Shalyt-Margolin, A.E. 427  
 Shapiro, A.H. 413  
 Shapiro, Asher 117  
 Sheldon, Eric 433  
 Shen, A.Q. 425  
 Shen, Amy 288, 289, 437  
 Sheng, Z. 425  
 Shephard, G.C. 421  
 Shinjo, K. 419  
 Shirham, King 29  
 Short, J. 431  
 Siart, Uwe 433  
 Siche, Dietmar 269, 437  
 Sierra, Bert 433  
 Sigwarth, J.B. 418  
 Sillett, S.C. 423  
 Silva 33  
 Silverman, M. 411  
 Simmons, J.A. 422  
 Simon, Julia 433  
 Simon, M.I. 411  
 Simonson, A.J. 390  
 Simplicius 332  
 Singh, C. 412  
 Singleton, Douglas 433  
 Sissa ben Dahir 29  
 Sitti, M. 415  
 Sitti, Metin 139  
 Slabber, André 433  
 Sluckin, T.J. 412  
 Smith, George 430  
 Smoluchowski, Marian von  
   303  
 Socrates 331  
 Sokal, A.D. 383  
 Soldner, J. 417  
 Soldner, Johann 164  
 Solomatin, Vitaliy 433  
 Sonett, C.P. 414  
 Song, Y.S. 415  
 Sotolongo-Costa, O. 428  
 Speleoresearch & Films/La  
   Venta 54, 435  
 Spence, J.C.H. 424  
 Spencer, R. 408  
 Spiderman 285  
 Spiess, H. 237  
 Spinelli, Matthew 79, 435  
 Spiropulu, M. 416  
 Sreedhar, V.V. 421  
 Sreenivasan, K.P. 424  
 Stalla, Wolfgang 285  
 Stasiak, A. 409  
 Stedman, G.E. 414  
 Steiner, Kurt 424  
 Stengel, Ingrid 408  
 Stephenson, Richard 414  
 Sternlight, D.B. 416  
 Steur, P.P.M. 425  
 Stewart, I. 406  
 Stewart, Ian 54  
 Stieber, Ralph 436  
 Stokes, Georges Gabriel  
   life 275  
 Stoney, G.J. 431  
 Stong, C.L. 411  
 Story, Don 433  
 Stroock, A.D. 423  
 Strunk, William 430  
 Su, Y. 418  
 Suchocki, John 404  
 Sugiyama, S. 411  
 Suhr, S.H. 415  
 Sum, Robert 437  
 Surdin, Vladimir 433  
 Surry, D. 410  
 Sussman, G.J. 418  
 Swackhamer, G. 419  
 Swatch Group 434  
 Sweetser, Frank 433  
 Swenson, C.A. 425  
 Swift, G. 427  
 Swinney, H.L. 428  
 Swope, Martha 429  
 Szczepanski, Daniela 284, 437  
 Szilard, L. 426  
 Szilard, Leo 306  
  
**T**  
 Taberlet, N. 428  
 Tabor, D. 419  
 Taimina, D. 420  
 Tait, P.G. 342  
 Takamoto, M. 431  
 Talleyrand 146  
 Tamman, Gustav 285  
 Tarko, Vlad 433  
 Tarski, Alfred 264  
   life 53

# T

---

TARTAGLIA

- Tartaglia, Niccolò 345  
   life 30  
 Taylor, B.N. 431  
 Taylor, E.F. 420  
 Taylor, G.J. 417  
 Tegelaar, Paul 433  
 Telegdi, V.L. 427  
 Tennekes, Henk 435  
 TERRA 138  
 Tetzlaff, Tim 435  
 Thaler, Jon 433  
 Thies, Ingo 433  
 Thinktank Trust 94, 435  
 Thomas Aquinas 265  
 Thompson, Dave 434  
 Thomson 99  
 Thomson (Kelvin), William  
   life 296  
 Thomson, W. 425  
 Thomson-Kelvin 288  
 Thorn, Christopher 260  
 Thoroddsen, S.T. 425  
 Thoroddsen, Sigurdur 288,  
   437  
 Titius, Johann Daniel 177  
 Tonzig, Giovanni 405  
 Topper, D. 416  
 Torge, Wolfgang 410  
 Toschek, P.E. 424  
 Townsend, Paul 433  
 Tracer 33  
 Trefethen, L.M. 413  
 Tregubovich, A.Ya. 427  
 Trevorrow, Andrew 433  
 Truesdell, C. 425  
 Truesdell, Clifford 32  
 Tsang, W.W. 419  
 Tschichold, J. 430  
 Tschira, Klaus 434  
 Tsuboi, Chuji 410  
 Tsukanov, Alexander 22, 434  
 Tucholsky, Kurt 219  
 Tuijn, C. 377  
 Tuppen, Lawrence 433  
 Turner, M.S. 415  
 Twain, Mark 106
- U**  
 Ucke, C. 386
- Uffink, J. 427  
 Uguzzoni, Arnaldo 433  
 Ulam, Stanislaw 318  
 ultimate wheel 435  
 Umbanhowar, P.B. 428  
 Umbanhowar, Paul 320, 321,  
   437  
 Universität Augsburg 272  
 Upright, Craig 433
- V**  
 Vandewalle, N. 425  
 Vanier, J. 430  
 Vannoni, Paul 433  
 Vareschi, G. 394  
 vector, Runge–Lenz 388  
 Verne, Jules 391  
 Vernier, Pierre  
   life 59  
 Vincent, D.E. 416  
 Vitali, Giuseppe 52  
 Viviani, Vincenzo 117  
 Voith 289  
 Volin, Leo 433  
 Vollmer, M. 425, 426  
 Vollmer, Michael 293, 437  
 Voltaire 179, 352  
   life 206  
 Vorobieff, P. 428  
 Voss, Herbert 433  
 Vries, de 251  
 Vuorinen, R.T. 431
- W**  
 Wagon, Stan 54, 409  
 Wald, George 308  
 Waleffe, F. 428  
 Walgraef, Daniel 428  
 Walker, J. 424  
 Walker, Jearl 282, 405, 424  
 Walker, John 148, 436  
 Wallis, J. 342  
 Walter, Henrik 419  
 Ward, R.S. 422  
 Warkentin, John 433  
 Weber, R.L. 428  
 Webster, Hutton 430  
 Wedin, H. 428  
 Wegener, Alfred 124, 415
- Wehner, R. 416  
 Wehus, I.K. 410  
 Weierstall, U. 424  
 Weierstrass, K. 342  
 Weil, André 342  
 Weiss, M. 410  
 Weiss, Martha 433  
 Wells, M. 419  
 Weltner, K. 424  
 Weninger, K.R. 411  
 West, G.B. 420  
 Westerweel, J. 428  
 Weyand, P.G. 416  
 Weyl, Hermann  
   life 45  
 Wheeler, John 365  
 Wheeler, T.D. 423  
 White, E.B. 430  
 White, M. 415  
 Whitney, C.A. 80  
 Widmer-Schmidrig, R. 421  
 Wienerroither, Peter 366, 437  
 Wierda, Gerben 433  
 Wierzbicka, Anna 408, 433  
 Wijk, Mike van 433  
 Wikimedia 33, 42, 111, 237, 260  
 Wilder, J.W. 383  
 Wiley, Jack 425  
 Wilk, Harry 409  
 Wilkie, Bernard 412  
 Williams, G.E. 414  
 Wilson, B. 422  
 Wisdom, J. 418  
 Wise, N.W. 432  
 Wittgenstein, Ludwig 15, 23,  
   25, 45, 78, 131, 191, 309, 334  
 Wittlinger, M. 416  
 Wittlinger, Matthias 139  
 Wolf, G.H. 423  
 Wolf, H. 416  
 Wolfsried, Stephan 54, 435  
 Wolpert, Lewis 406  
 Wong, M. 411  
 Wright, Joseph 434  
 Wright, S. 416  
 Wulfila 339
- Y**  
 Yamafuji, K. 425

- Yamaguchi University 327, 437  
Yatsenko, Dimitri 371  
Young, Andrew 433  
Young, Thomas 97  
Yourgray, Wolfgang 420  
Yukawa Hideki 345
- Z**  
Zabusky, N.J. 422
- Zabusky, Norman 252  
Zaccone, Rick 433  
Zakharian, A. 414  
Zalm, Peer 433  
Zanker, J. 407  
Zedler, Michael 433  
Zenkert, Arnold 408  
Zeno of Elea 14, 16, 61, 76  
Zheng, Q. 423
- Ziegler, G.M. 53  
Zimmermann, H.W. 427  
Zimmermann, Herbert 307  
Zweck, Josef 413  
Zwieniecki, M.A. 423  
Zürn, W. 421

# Y

---

YAMAGUCHI





# SUBJECT INDEX



## Symbols

( 342  
 ) 342  
 + 342  
 − 342  
 · 342  
 × 342  
 : 342  
 < 342  
 = 342  
 > 342  
 ∅ 342  
 ≠ 342  
 $\sqrt{\quad}$  342  
 @ (at sign) 343  
 $\Delta$  342  
 $\infty$  342  
 $\nabla$  342

## A

a (year) 39  
 abacus 341  
 Abelian, or commutative 221  
 aberration 114, 125  
 abjad 340  
 abugida 340  
 Academia del Cimento 69  
 acausality 192  
 acceleration 76  
 acceleration, centrifugal 133  
 acceleration, centripetal 133,  
 143  
 acceleration, tidal 162  
 accelerations, highest 84  
 accelerometer 367  
 accents, in Greek language  
 339

accumulation 290  
 accuracy 333, 352  
 limits to 353  
*Acetabularia* 43  
*Acinonyx jubatus* 34  
 Ackermann steering 373  
 acoustical thermometry 425  
 action 201, 224  
 action, physical 199  
 action, principle of least 152  
 action, quantum of 306  
 action, quantum of,  $\hbar$   
 physics and 8  
 actuators 186  
 addition 221  
 additivity 35, 41, 47, 94  
 additivity of area and volume  
 52  
 adenosine triphosphate 412  
 aeroplanes 91  
 aerostat 281  
 AFM, atomic force  
 microscope 272  
 aggregates of matter 208  
 air 397  
 air composition 397  
 air pressure 96  
 Airbus 368  
 airflow instruments 246  
 alchemy 32  
 Aldebaran 79, 211  
 aleph 339  
 algebraic surfaces 363  
 Alice in Wonderland 307  
 allometric scaling 35  
 Alpha Centauri 211  
 alphabet 338

alphabet, Greek 338  
 alphabet, Hebrew 340  
 alphabet, Latin 336  
 alphabet, phonemic 340  
 alphabet, story of 337  
 alphabets, syllabic 340  
 alphasyllabaries 340  
 Alps 151, 177  
 Altair 211  
 Amazon 124  
 Amazon River 254, 283  
*Amoeba proteus* 82  
 ampere  
 definition 347  
 amplitude 236  
 analemma 172  
 angels 20, 87  
 angle 103  
 angle, plane 62  
 angle, solid 62  
 angular acceleration 103  
 angular momentum 102, 103,  
 133  
 angular momentum  
 conservation 152  
 angular momentum, extrinsic  
 103, 104  
 angular momentum, intrinsic  
 103  
 angular velocity 101, 103  
 anharmonicity 250  
 anholonomic constraints 205  
 Antares 79, 211  
 anti-bubbles 283  
 anti-Hermitean 223  
 anti-unitary 223  
 antigravity 159, 166

## A

## ANTIGRAVITY

- antigravity device 167  
antimatter 94  
Antiqua 339  
antisymmetry 223  
apex angle 375  
aphelion 356  
*Aphistogoniulus erythrocephalus* 82  
*Apis mellifera* 93  
apnoea 277  
apogee 356  
Apollo 388  
apple trees 352  
apple, standard 352  
apples 87  
Aquarius 173  
aqueducts 277  
Arabic numbers 340  
*Arabidopsis* 43  
Arcturus 211  
argon 397  
Aries 173  
Aristotelian view 184  
Aristotle 386  
arithmetic sequence 366  
*Armillaria ostoyae* 49, 93  
arrow of time 45  
artefact 82, 348  
ash 337  
associativity 221  
asteroid 172  
asteroid, Trojan 159  
asteroids 173, 211  
Astrid, an atom 423  
astrology 155, 173  
astronomers, smallest known 157  
astronomical unit 177  
astronomy picture of the day 363  
at-sign 343  
athletics 139  
atmosphere of the Moon 315  
atmosphere, composition 397  
atomic clock 42  
atomic force microscope 272, 382  
atomic force microscopes 189  
Atomium 288
- atoms 271  
atoms are not indivisible 311  
atoms, manipulating single 272  
ATP 96, 412  
atto 349  
Atwood machine 387  
augmented fourth 247  
auricola 257  
austenitic steels 286  
average 206  
Avogadro's number 265, 281, 355  
axioms 33  
axis of the Earth, motion of 124  
axis, Earth's 127  
axle, impossibility in living beings 378
- B**  
Babylonia 344  
Babylonians 178  
background 24, 26, 46  
bacteria 82  
bacterium 100  
badminton serve, record 34  
badminton smashes 371  
*Balaenoptera musculus* 93, 253  
balloons 302  
balloon rope puzzle 281  
Banach measure 52  
Banach–Tarski paradox or theorem 53, 264  
banana catching 105  
barycentre 175  
baryon number density 358  
base units 347  
*Basiliscus basiliscus* 138  
basilisk 138  
bath-tub vortex 413  
bathroom scale 132  
bathroom scales 286  
bathtub vortex 117  
BCE 344  
bear puzzle 57  
bear, colour of 57  
Beaufort 34  
beauty 17, 318, 322  
beauty, origin of 318  
becquerel 349  
beer 283  
beer mat 58  
beetle, click 137  
before the Common Era 344  
behaviour 19  
belief systems 87  
beliefs 21  
Belousov-Zhabotinski reaction 327  
Bernoulli equation 273, 282  
Bernoulli's equation 273  
Bessel functions 125  
Betelgeuse 79, 211  
beth 339  
bets, how to win 118  
bicycle 379  
bicycle riding 87  
bicycle weight 302  
billiards 90  
bimorphs 186  
biographies of mathematicians 363  
biological evolution 20, 318  
biology 186  
BIPM 347, 348  
bird speed 34  
bird, singing 260  
bismuth 39  
bits to entropy conversion 355  
black holes 192  
blasphemy 113  
block and tackle 29  
blood pressure 278  
blood supply 81  
board divers 105  
boat 95  
Bode's rule 177  
bodies, rigid 195  
body 25  
body fluids 278  
Bohr radius 355  
Boltzmann constant 301, 303, 306, 309, 354  
Boltzmann constant  $k$  physics and 8  
book and physics paradox 333  
books 336

# B

---

BOOKS

- books, information and  
 entropy in 306  
 boost 229  
 bottle 95, 110  
 bottle, full 197  
 boundaries 86  
 boundary layer 392  
 brachistochrone 195, 393  
 braid pattern 327  
 brain 314  
 brain and physics paradox 333  
 brain stem 24  
 brass instruments 246  
 Braun GmbH 294  
 bread 265, 369  
 breathings 339  
 brooms 167, 394  
 brown dwarfs 211  
 Brownian motion 303, 304  
 browser 361  
 bubbles 282  
 bucket 17  
 bucket experiment, Newton's  
 132  
 bullet speed 34  
 bullet speed measurement 56  
 Bunsen burner 295  
 Bureau International des  
 Poids et Mesures 347  
 bushbabies 137  
 butterfly effect 324  
 button, future 307
- C**  
 c. 344  
 caesium 39  
 calculating prodigies 341  
 calculus of variations 204  
 calendar 343, 344  
 calendar, Gregorian 344  
 calendar, Julian 343  
 calendar, modern 344  
 caliper 50, 59  
 Callisto 170  
 calorie 351  
*Calpodes ethlius* 72  
 camera 61  
 Cancer 173  
 candela  
 definition 347  
 candle 29, 315  
 canoeing 138  
 Canopus 211  
 cans of peas 135  
 cans of ravioli 135  
 capacity 291  
 Capella 211  
 Capricornus 173  
 capture, in universal gravity  
 173  
 car parking 60  
 car weight 302  
*Carparachne* 81  
 carriage, south-pointing 196,  
 420  
 cars 333  
 Cartesian 48  
 cartoon physics, 'laws' of 86  
 cat 95  
*Cataglyphis fortis* 139  
 catenary 375  
 caterpillars 71  
 causal 192  
 causality of motion 192  
 cavitation 84, 248  
 cavity resonance 261  
*Cebrennus* 81  
 celestocentric system 369  
 Celsius temperature scale 292  
 Celtic wiggle stone 134  
 cement kiln 379  
 cementite 287  
 centi 349  
 centre of gravity 172  
 centre of mass 103, 172  
 centrifugal acceleration 133,  
 144  
 centrifugal force 151  
 centripetal acceleration 133  
*Cerebrennus* 411  
 cerebrospinal fluid 278  
 Ceres 173  
 cerussite 54  
 Cetus 173  
 chain 63  
 challenge classification 9  
 challenges 24  
 chandelier 146  
 chaos 322, 324  
 chapter sign 343  
 charge 228  
 elementary *e*, physics and  
 8  
 chaturanga 29  
 check 219  
 cheetah 34, 77  
 chemistry 332  
 chess 29  
 chest operations 397  
 child's mass 108  
 childhood 34, 46  
 Chimborazo, Mount 151  
 chocolate 279  
 chocolate bar 263  
 chocolate does not last  
 forever 263  
 Chomolungma, Mount 151,  
 283  
 circalunar 157  
 circle packing 376  
 circular definition in physics  
 334  
 classical electron radius 355  
 classical mechanics 182  
 Clay Mathematics Institute  
 275  
 click beetles 137  
 clock 40, 41, 96, 146  
 clock puzzles 58, 405  
 clock, air pressure powered 96  
 clock, exchange of hands 58  
 clocks 40, 334  
 clockwise rotation 44  
 closed system 299, 300  
*Clunio* 156  
 coastline length 49  
 CODATA 431  
 coffee machines 298  
 collisions 96, 186, 332  
 colour symmetries 215  
 comet 158  
 comet, Halley's 158  
 comic books 285  
 Commission Internationale  
 des Poids et Mesures 347  
 compass 196  
 completeness 41, 47, 94



## C

## COMPLEXITY

- complexity 306
  - Compton tube 118
  - Compton wavelength 355
  - Compton wheel 118
  - computers 314
  - concatenation 221
  - concave Earth theory 369
  - concepts 333
  - conditions for motion's
    - existence 16
  - conductance quantum 355
  - Conférence Générale des Poids et Mesures 347, 352
  - configuration 25
  - configuration space 70
  - Conférence Générale des Poids et Mesures 348
  - conic sections 157
  - connected bodies 81
  - conservation 94, 233
  - conservation of momentum
    - 95
  - conservation principles 113
  - conservative 187
  - conservative systems 205
  - conserved quantities 16
  - constellations 79, 173
  - constraints 205
  - contact 332
  - container 46
  - containers 48
  - continental motion 124
  - continuity 41, 46, 47, 94, 225
  - continuity equation 185
  - continuity, limits of 67
  - continuum 35
  - continuum approximation 80
  - continuum mechanics 197
  - continuum physics 290
  - convection 300
  - Convention du Mètre 347
  - conventions 336
  - cooking 332
  - cooperative structures 322
  - coordinates 47, 68
  - coordinates, generalized 205
  - Copernicus 413
  - Corallus caninus* 294
  - Coriolis acceleration 116, 383, 413
  - Coriolis effect 116, 383, 413
  - cork 95, 110
  - corn starch 327, 329
  - corner figures 24
  - corner film, lower left 24, 25
  - corner patterns 24
  - corner, lower left film 24, 25
  - corpuscle 79
  - corrugations, road 320, 321
  - cortex 24
  - cosmic evolution 20
  - cosmic mirror 363
  - cosmological constant 357
  - cosmonauts 388
  - cosmos 26
  - coulomb 349
  - countertenors 262
  - CPT 230
  - crackle 378
  - crackpots 364
  - creation 16
  - creation of motion 95
  - crest 241
  - cricket bowl 371
  - crooks 329
  - cross product 99
  - crystal classes 218
  - crystal groups 218
  - crystallographic point groups
    - 218
  - crystals 54
  - cumulonimbus 255
  - curiosities 28
  - curiosity 17, 194
  - curvature 59
  - curves of constant width 30
  - curvimeter 51
  - cycle 249
  - cycloid 214, 393
  - Cyrillic alphabet 339
- D**
- $\partial$  342
  - dx 342
  - daleth 339
  - damping 185, 241
  - dancer 71
  - dark stars 211
  - Davey–Stewartson equation
    - 260
  - day length, past 39
  - day, length of 163
  - day, mean solar 126
  - day, sidereal 126, 355
  - day, time unit 349
  - de Broglie wavelength 348
  - dead water 238
  - death 14, 96, 101, 227, 265, 334
  - death sentence 265
  - deca 349
  - decay 314
  - deci 349
  - deer 24
  - degree Celsius 349
  - degree, angle unit 349
  - delta function 244
  - denseness 41, 47
  - derivative 74
  - derivative at a point 75
  - description 68
  - descriptions, accuracy of 333
  - Desmodium gyrans* 43
  - details and pleasure 18
  - determinism 192, 193, 325
  - devil 23
  - Devonian 163
  - diamond 213
  - diamond, breaking 285
  - Diet Coca Cola 283
  - differential 75
  - differential equation 370
  - diffraction 241
  - diffusion 314, 315
  - digamma 338
  - digits, history of 340
  - dihedral angles 53
  - dilations 227
  - dimensionality 35, 47
  - dimensionless 355
  - dimensions 46
  - diminished fifth 247
  - direction 35
  - disappearance of motion 95
  - discrete 220
  - dispersion 241, 242
  - dissection of volumes 53
  - dissipative 187

# D

---

DISSIPATIVE

- dissipative systems 189, 204, 322  
 distance 49  
 distinguish 23  
 distinguishability 35, 41, 47, 94  
 distribution, Gaussian 352  
 distribution, Gaussian normal 304  
 distribution, normal 352  
 divergence 150  
 diving 277  
 DNA 49, 352  
 DNA (human) 210  
 DNA, ripping apart 183  
 Dolittle 206  
 donate  
   for this free pdf 9  
 doublets 223  
 Dove prisms 411  
 drag 185, 188  
 drag coefficient 188, 333  
 dromion 261  
 drop 188  
*Drosophila melanogaster* 43  
 duck, wake behind 259  
 ducks, swimming 255  
 Duration 39  
 Dutch Balloon Register 437  
 duvet 300  
 dwarf planets 173  
 dwarfs 211  
 dx 342  
 dyadic product 342  
 dynabee 136  
 dynamic friction 187  
 dynamics 182
- E**  
 e.g. 344  
 ear 46, 49, 242, 269, 421  
 ear problems 257  
 ear, human 257  
 Earth 114, 300  
 Earth dissection 54  
 Earth from space 363  
 Earth speed 34  
 Earth stops rotating 151  
 Earth's age 39, 356  
 Earth's average density 356  
 Earth's axis 127  
 Earth's gravitational length 356  
 Earth's mass, time variation 166  
 Earth's radius 356  
 Earth's rotation 350  
 Earth's rotation change of 121  
 Earth's shadow 136  
 Earth's speed through the universe 130  
 Earth, flat 378  
 Earth, flattened 114  
 Earth, hollow 55  
 Earth, mass of 146  
 Earth, shape of 151  
 earthquake 134, 385  
 earthquake, starting 286  
 earthquake, triggered by humans 286  
 earthquakes 134, 156, 415  
 eccentricity 159  
 eccentricity of Earth's axis 128  
 echo 242  
 ecliptic 152  
 effort 183  
 egg cooking 311  
 eigenvalues 223  
 Ekman layer 413  
 elasticity 186  
 elders 361  
 Elea 270  
 electric effects 186  
 electromagnetism 148  
 electron speed 34  
 element of set 35, 41, 47, 94  
 elephants 255, 318  
 ellipse 145, 157  
 email 361  
 emergence 325  
 emergent properties 325  
 emit waves 242  
 empty space 150, 240  
 EMS98 134  
 energy 97, 185, 211, 225  
 energy conservation 99, 152, 228  
 energy consumption in First World countries 99  
 energy flows 95  
 energy of a wave 240  
 energy, observer independence 225  
 energy, scalar generalization of 225  
 energy, total 150  
 enlightenment 164  
 entropy 291, 334  
   definition 297  
   random motion and 297  
 entropy flow 299  
 entropy, quantum of 307  
 entropy, smallest in nature 306  
 entropy, state of highest 316  
 environment 24  
*Epargyreus clarus* 72, 410  
 ephemeris time 40  
 eponyms 345  
 EPR 345  
 equal intonation 247  
 equilibrium 298  
 equilibrium, thermal 298  
 Eris 173  
 errors  
   in measurements 352  
 ESA 363  
 escape velocity 171  
*Escherichia coli* 82  
 et al. 344  
 eth 337, 429  
 ethel 337  
 ethics 194  
*Eucalyptus regnans* 267  
 Eucharist 265  
 Euclidean space 47  
 Euclidean vector space 33, 35  
 Europa 170  
 evaporation 314  
 evenings, lack of quietness of 255  
 event 39  
 Everest, Mount 151, 283  
 everlasting life 96  
 everything flows 16  
 evolution 25  
 evolution equations 191  
 Exa 349

## E

## EXCLAMATION

- exclamation mark 343  
 exclusion principle 208  
 expansion 292  
 expansion of the universe 130  
 expansions 227  
 Experience Island 15, 20  
 exponential notation 60  
 extended bodies, non-rigid 196  
 extension 272  
 extensive quantities 291  
 extensive quantity 95  
 extrasolar planets 211  
 eye 24  
 eye motion 47  
 eye, blinking after guillotine 89  
 eyelid 59  
 eyes of fish 282
- F**  
*F. spectabilis* 43  
*F. suspensa* 43  
*F. viridissima* 43  
*Falco peregrinus* 34  
 fall 143  
 fall and flight are independent 69  
 fall is not vertical 114  
 fall is parabolic 70  
 fall of Moon 143  
 familiarity 23  
 family names 345  
 fantasy and physics 334  
 farad 349  
 farting for communication 256  
 fear of formulae 30  
 feet 278  
 femto 349  
 Fermi coupling constant 354  
 Fermi problems 311  
 Fermilab 60  
 ferritic steels 286  
 Fiat Cinquecento 280  
 fifth, perfect 247  
 figures in corners 24  
 filament 295  
 fine structure constant 354
- finite 310  
 fire 295  
 fish's eyes 282  
 flagella 82  
 flagellar motor 100  
 flame 29, 133, 312  
 flatness 55  
 flattening of the Earth 114  
 fleas 137  
 flies 24  
 flip film 24  
 flip film, explanation of 68  
 flow 290  
 flow of time 45  
 fluid mechanics 196  
 fluids, body 278  
 flute 234  
 fly, common 147  
 flying saucers 256  
 focal point 377  
 focus 377  
 foetus 247  
 force 92, 103  
   definition of 183  
   force, central 92  
   force, physical 183  
   force, use of 182  
 Ford and precision 333  
 forest 24  
 formulae, ISO 429  
 formulae, liking them 30  
*Forsythia europaea* 43  
 Foucault's pendulum, web cam 117  
 fountain, Heron's 280  
 Fourier analysis 237  
 Fourier decomposition 237  
 Fourier transformation 258  
 fourth, perfect 247  
 fractals 50, 76, 263  
 frames of reference 215  
 frass 71  
 free fall, speed of 34  
 free will 193  
 frequency 238  
 friction 96, 185, 187, 188, 298, 308  
 Friction between planets and the Sun 96
- friction produced by tides 163  
 friction, importance of 298  
 froghopper 77  
 Froude number, critical 254  
 fuel consumption 333  
 full width at half maximum 353  
 funnel 282, 283  
 Futhark 337  
 Futhorc 337  
 futhorc 339  
 future button 307  
 future, fixed 192  
 future, remembering 307
- G**  
 Gaia 324  
 gait 106  
 galaxy centre 128  
 galaxy cluster 209  
 galaxy group 209  
 galaxy supercluster 209  
 Galilean physics 27, 32, 182, 331  
 Galilean satellites 170  
 Galilean space 47  
 Galilean space-time 67  
 Galilean time 41  
 Galilean velocity 33  
 galvanometer 186  
 Ganymede 170  
 gas 301  
 gas planets 211  
 gauge change 220  
 gauge symmetries 227  
 gauge theory 45  
 Gaussian distribution 304, 352  
 Gemini 173  
 generalized coordinates 207  
 generators 228  
 Geocentric gravitational constant 356  
 geocentric system 175  
 geodesics 189  
 geoid 151  
 geological maps 363  
 geometric sequence 366  
 geometric symmetries 215  
 geostationary satellites 159

# G

GERRIDAE

- Gerridae* 138  
 ghosts 28, 87  
 Giant's Causeway 54, 327  
 giants 267  
 Giga 349  
 gimel 339  
 girl-watching 137  
 glass 285  
 Global infrasound Network 258  
 global warming 256, 300  
 gnomonics 40  
 gods 32, 113, 132, 138, 160, 405, 407  
 gold 369  
 golf balls 371  
 Gondwanaland 124  
 gorilla test for random numbers 192  
 Gosper's formula 313  
 Gothic alphabet 339  
 Gothic letters 339  
 GPS 40  
 grace 21, 106, 329, 406  
 gradient 148  
 granular jet 288  
 gravitation 141, 186  
 gravitation and measurements 335  
 gravitational acceleration, standard 77  
 gravitational constant 142  
 gravitational constant  $G$  physics and 8  
 gravitational coupling constant 354  
 gravitational field 151  
 gravitational mass 165  
 gravity inside matter shells 175  
 gravity waves 239  
 gravity, centre of 172  
 gravity, essence of 176  
 gravity, sideways action of 146  
 gray 349  
 Greek alphabet 338  
 Greek number system 341  
 greenhouse effect 300  
 Greenland 39  
 Gregorian calendar 344  
 Gregorian calendar reform 60  
 group, mathematical 221  
 growth 20, 198, 318  
 growth of deep sea manganese crust 34  
 Gulf Stream 413  
 guns and the Coriolis effect 117  
 gymnasts 105  
 gynecologist 247  
 gyromagnetic ratio of the electron 332  
 gyroscope 104, 118  
 gyroscope, laser 120
- H**  
 hafnium carbide 295  
 Hagedorn temperature 295  
 hair clip 187  
 hair growth 34  
 hair, diameter 49  
 halfpipe 214  
 Hamilton's principle 199  
 hammer drills 109  
 hands of clock 58  
 hard discs, friction in 189  
 harmonic motion 234  
 heartbeat 146  
 heat  
   in everyday life 297  
   in physics 297  
 heat & pressure 186  
 heat engines 296  
 Hebrew alphabet 340  
 hecto 349  
 helicity of stairs 44  
 helicopter 282  
 helicopters 364  
 heliocentric system 175  
 helium 209, 295, 314  
 helium, superfluid 281  
 henry 349  
 heresy 265  
 Hermitean 223  
 Heron's fountain 280  
 herring, farting 256  
 hertz 349  
 hiccup 329  
 Himalaya age 39  
 hips 106  
 hodograph 70, 143, 170  
 holes 26  
 hollow Earth theory 55  
 Hollywood 206  
 Hollywood films 199, 263, 411  
 holonomic 205  
 holonomic systems 205  
 holonomic-rheonomic 205  
 holonomic-scleronomic 205  
*Homo sapiens* 43  
 homogeneity 41, 47  
 homomorphism 222, 223  
 honey bees 93  
 Hooke 152  
 Hopi 408  
 horse 100  
 horse power 100  
 horses, speed of 71  
 hour 349  
 hourglasses 57  
 Hubble parameter 357  
 Hubble space telescope 363  
 Hudson Bay 39  
 human growth 34  
 humour 325  
 humour, physical 363  
 Huygens' principle 244  
 hydrofoils 276  
 Hydroptère 34  
 hyperbola 157
- I**  
 i.e. 344  
 ibid. 344  
 IBM 437  
 ice ages 127, 415  
 iceberg 93  
 icicles 286  
 icosane 305  
 ideal 48  
 ideal gas 292, 301  
 ideal gas constant 292, 400  
 idem 344  
*Illacme plenipes* 84  
 illness 278  
 illusions of motion 15  
 illusions, optical 363  
 image 86

- images 26  
 imagine 219  
 immovable property 88  
 impenetrability 94  
 impenetrability of matter 32  
 inclination of Earth's axis 128  
 indeterminacy relation 249  
 indeterminacy relation of  
   thermodynamics 307  
 index of refraction 394  
 Indian digits 340  
 Indian number system 341  
 Indian numbers 340, 341  
 Indian numbers and digits  
   340  
 individuality 26, 190  
 inductions 228  
 inertia 87  
 inertial mass 165  
 inf. 344  
 infinite coastlines 50  
 infinite number of SI prefixes  
   352  
 infinity 16, 35, 41, 47, 94  
 infinity in physics 75  
 information 306  
 information, erasing of 314  
 information, quantum of 307  
 infrasound 257  
 initial conditions 190  
 injective 223  
 inner world theory 369  
 Inquisition 266  
 insects 157, 315  
 instant 32, 38  
 instant, human 39  
 instant, single 16  
 insulation power 300  
 integral 202  
 integration 52, 202  
 interaction 26, 183  
 interference 241  
 interferometer 91, 118  
 internal 220  
 International Earth Rotation  
   Service 350, 414, 417  
 International Geodesic Union  
   357  
 International Latitude Service  
   124, 414  
 International Phonetic  
   Alphabet 336  
 internet 360, 361  
 interval, musical 247  
 invariance 94, 220  
 invariant property 215  
 inverse element 221  
 invisibility of objects 80  
 invisible loudspeaker 313  
 Io 163, 170  
 ionosphere, shadow of 136  
 IPA 336  
 irreducible 223  
 irreversibility of motion 192  
 irreversible 298  
 Island, Experience 15  
 isolated system 300  
 isomorphism 223  
 isotomeograph 118  
*Istiophorus platypterus* 34, 277  
 Isua Belt 39  
 italic typeface 336  
 IUPAC 431  
 IUPAP 431
- J**  
 jerk 190, 378  
 Jesus 138  
 Josephson effect 348  
 Josephson frequency ratio 355  
 joule 349  
 juggling 72  
 juggling robot 72  
 Julian calendar 343  
 jump 137  
 jump, long 410  
 jumping height of animals 73  
 Jupiter 175, 211  
 Jupiter's mass 356  
 Jupiter's moons 177  
 just intonation 247
- K**  
 k-calculus 367  
 Kadomtsev–Petviashvili  
   equation 261  
 kefir 210  
 kelvin  
   definition 347  
 Kepler's laws 152  
 ketchup motion 34  
 kilo 349  
 kilogram  
   definition 347  
 kilotonne 98  
 kinematics 68, 182  
 kinetic energy 97  
 Klitzing, von – constant 355  
 knot 66  
 knowledge, humorous  
   definition of 392  
 knuckle angles 62  
 koppa 338  
 Korteweg–de Vries equation  
   251, 261  
 Kuiper belt 173, 210  
 Kurdish 337
- L**  
 ladder 110  
 ladder puzzles 65  
 ladder, sliding 110  
 Lagrange's equations of  
   motion 205  
 Lagrangian (function) 202  
 Lagrangian is not unique 205  
 Lagrangian libration points  
   159  
 laminarity 273  
 languages on Earth 340  
 large 234  
 laser gyroscopes 120  
 laser loudspeaker 313  
 lateral force microscopes 189  
 Latin 344  
 Latin alphabet 336  
 lawyers 88  
 laziness, cosmic, principle of  
   195, 204  
 lead 280  
 leaf, falling 283  
 leaning tower in Pisa 69  
 leap day 343  
 leapfrogging of vortex rings  
   284  
 learning 23  
 learning mechanics 184

# L

---

LEARNING

- learning, best method for 8
  - Lebesgue measure 54
  - lecture scripts 363
  - leg 146
  - leg performance 137
  - Lego 271
  - legs 28
  - Leidenfrost effect 282
  - length 46, 49, 74, 335
  - length scale 315
  - Leo 173
  - letters 337
  - Leucanthemum vulgare* 198
  - levitation 159
  - Libra 173
  - librations 155
  - lichen growth 34
  - life, shortest 39
  - lift into space 285
  - light 186
  - light deflection near masses 164
  - light mill 186
  - light speed measurement 56
  - light tower 34
  - light year 356
  - light, slow group velocity 408
  - lightbulb temperature 295
  - lighthouse 66
  - lightning speed 34
  - limbic system 406
  - limits
    - to precision 353
  - Listing's 'law' 137
  - litre 349
  - living thing, heaviest 93
  - living thing, largest 49
  - lizard 138
  - local time 39
  - locusts 137
  - logarithms 153
  - long jump 70, 71, 98, 410
  - Loschmidt's number 265, 281
  - lottery, rigging 293
  - loudspeaker with laser 313
  - loudspeaker, invisible 313
  - love 21, 148
  - Love number 126
  - low-temperature physics 302
  - lowest temperature 293
  - luggage 180
  - lumen 349
  - lunar calendar 39
  - Lunokhod 388
  - lux 349
  - Lyapounov exponent 324
  - lymph 278
- M**
- M82, galaxy 77
  - mach 91
  - Mach's principle 91
  - machine 82
  - magnetization of rocks 125
  - magic 363
  - Magna Graecia 270
  - magnetic effects 186
  - magnetic flux quantum 355
  - magnetic thermometry 425
  - magnetism 92
  - magnitudes 225
  - main result of modern science 308
  - male sopranos 262
  - man, wise old 206
  - many-body problem 331
  - marble, oil covered 95
  - Mars 350
  - martensitic steels 286
  - mass 89, 92, 185, 335
  - mass conservation implies momentum conservation 91
  - mass is conserved 89
  - mass of children 108
  - mass of Earth, time variation 166
  - mass, centre of 172
  - mass, Galilean 92
  - mass, gravitational 165
  - mass, identity of gravitational and inertial 165
  - mass, inertial 87, 165
  - mass, negative 92, 94
  - math forum 363
  - mathematicians 363
  - mathematics 33
  - maths problem of the week 363
  - matrix, adjoint 223
  - matrix, antisymmetric 223
  - matrix, complex conjugate 223
  - matrix, orthogonal 223
  - matrix, symmetric 223
  - matrix, transposed 223
  - matter 79, 87
  - matter shell, gravity inside 175
  - matter, impenetrability of 32
  - meaning 17
  - measurability 35, 41, 47, 94
  - measure 335
  - measurement 35
    - definition 347, 350
  - measurement errors 352
  - measurements and gravitation 335
  - mechanics 182, 195
  - mechanics, classical 182
  - mechanics, quantum 182
  - Medicean satellites 170
  - medicines 28
  - Mega 349
  - megatonne 98
  - memorize 23
  - memory 29, 298
  - menstrual cycle 157, 417
  - Mentos 283
  - Mercalli scale 134
  - Mercury 160
  - meridian 146
  - Mesopotamia 336
  - metallurgy 332
  - meteorites 258
  - meteroids 211
  - metre
    - definition 347
  - metre sticks 334
  - metricity 35, 41, 47, 94
  - micro 349
  - microscope, atomic force 272, 382
  - microwave background temperature 358
  - mile 350
  - Milky Way's age 357
  - Milky Way's mass 357



# M

---

MILKY

- Milky Way's size 357  
 milli 349  
 mind change 19  
 minerals 363  
 mini comets 173  
 minor planets 211  
 minute 349, 357  
 Mir 180  
 mirror invariance 27  
 moguls, ski 321  
 mole  
   definition 347  
 molecules 271  
 moment 40  
 moment of inertia 101, 103, 225, 231  
 moment of inertia, extrinsic 103  
 moment of inertia, intrinsic 103  
 momentum 90, 95, 97, 185, 211  
   as a liquid 183  
   change 183  
   flow 183  
 momentum conservation  
   follows from mass conservation 91  
 momentum flows 95  
 momentum of a wave 240  
 momentum, angular 103  
 money, humorous definition of 392  
 monocycle 87  
 month 343  
 Moon 143  
 Moon calculation 143  
 Moon density and tides 162  
 Moon illusion 63  
 Moon path around Sun 171  
 Moon phase 175  
 Moon size illusion 63  
 Moon size, angular 63  
 Moon size, apparent 143  
 Moon's atmosphere 315  
 Moon's mass 356  
 Moon's mean distance 356  
 Moon's radius 356  
 Moon, dangers of 163  
 Moon, fall of 143  
 moons 210  
 moped 113  
 morals 194  
 mornings, quietness of 255  
 moth 276  
 motion 26, 334  
   does not exist 15  
   is fundamental 348  
 motion and measurement units 348  
 motion as an illusion 16  
 motion as illusion 16  
 motion detectors 29  
 motion illusions, figures showing 15  
 motion invariance 27  
 motion is based on friction 187  
 motion is change of position with time 68  
 motion is due to particles 22  
 motion is predictable 331  
 motion is relative 25  
 motion is the change of state of objects 26  
 Motion Mountain 15  
 motion of continents 34  
 motion, conditions for its existence 16  
 motion, drift-balanced 407  
 motion, faster than light 308  
 motion, harmonic 234  
 motion, infinite 335  
 motion, manifestations 15  
 motion, non-Fourier 407  
 motion, passive 21, 187  
 motion, simplest 23  
 motion, unlimited 335  
 motion, volitional 20  
 motion, voluntary 187  
 motor bike 88  
 motor, electrostatic 186  
 motor, linear 186  
 motors 186  
 moustache 50  
 movable property 88  
 movement 21  
 multiplet 221  
 multiplication 221  
*Musca domestica* 43, 77  
 myosotis 215  
 mystery of motion 14
- ## N
- nabla 342  
 names of people 345  
*Nannosquilla decemspinosa* 82  
 nano 349  
*Nanoarchaeum equitans* 210  
 NASA 350  
 NASA 363  
 natural 48  
 nature 26  
 Navier–Stokes equations 275  
 needle on water 283  
 negative vector 73  
 neocortex 406  
 Neptune 173, 175  
 nerve signal speed 34  
*Neurospora crassa* 43  
 neutral element 221  
 neutrino 273  
 neutron stars 210  
 newspaper 427  
 newton 349  
 Newtonian physics 32, 182  
 NGC 2240 295  
 Niagara 263  
 Niagara Falls 325  
 nitrogen 280  
 Noether charge 228  
 Noether's theorem 227  
 noise 303  
 noise thermometry 425  
 noise, (physical) 249  
 nonholonomic constraints 205  
 nonius 59  
 norm 74  
 normal distribution 304  
 normality 432  
 North Pole 44, 124, 151  
 notation 336  
 notation, scientific 336  
 nuclear explosions 256  
 nuclear magneton 355  
 nuclei 186  
 nucleon 273

# N

---

NULL

null vector 73  
 numbers 225  
 nutation 127

## O

object 24, 25, 38, 86  
 objects 26, 334  
 obliquity 127, 390  
 oboe 248  
 observables 26, 224  
 observables, discrete 225  
 oceanography 258  
 octave 247  
 octet 223  
 odometer 49  
 ohm 349  
 oil 95, 282  
 oil film experiment 264  
 Olympic year counting 344  
 Oort cloud 210  
 op. cit. 344  
 operator 150  
 Ophiuchus 173  
 optical radiation  
   thermometry 425  
 orbit, elliptical 153  
 order 41, 47, 94, 318  
 order parameter 322  
 orgasms 329  
 orientation change needs no  
   background 104  
 origin, human 14  
 original Planck constant 354  
 Orion 79  
 orthogonality 74  
 oscillation 234  
 oscillation, harmonic or  
   linear 234  
 oscillons 320  
 osmosis 186, 314  
 otoacoustic emissions 242  
 outer product 342  
 oxygen 280

## P

$\pi$  and gravity 145  
 $\pi = 3.141592\dots$  432  
 paeelite 287  
 painting puzzle 180

paper aeroplanes 364  
 paper boat contest 280  
 parabola 63, 70, 145, 157  
 parachutes 187  
 paradox about physics books  
   333  
 parallax 114, 125  
 parallelepiped 101  
 parenthesis 343  
 parity invariance 27  
 parking challenge 60  
 parsec 356  
 particle 79  
 particle data group 362  
 parts 26, 79, 309  
 pascal 349  
 passim 344  
 passive motion 191  
 path 68  
 Paul trap 273  
 pea dissection 54  
 pearls 285  
 peas 135  
 Peaucellier-Lipkin linkage 196  
 pee research 327  
 peers 361  
 Peirce's puzzle 58  
 pencil, invention of 32  
 pencils 57  
 pendulum 146  
 penguins 106  
 people names 345  
 performers 361  
 perigee 356  
 perihelion 160, 356  
 perihelion shift 128, 159  
 period 236  
 permanence 23  
 permanence of nature 16  
 permutation symmetry 220  
 perpetual motion machine 96  
 perpetuum mobile 93  
 perpetuum mobile, first and  
   second kind 96  
 Peta 349  
 phase 236, 238  
 phase space 26, 190  
 phase space diagram 70  
 PhD, enjoying it 329

*Philaenus spumarius* 77  
 photoacoustic effect 313, 314  
 photon number density 358  
 physical observations 219  
 physical system 26  
 physicists 362  
 physics 14  
   map of 8  
 physics problems 362  
 physics, circular definition in  
   334  
 physics, everyday 27  
 physics, outdated definition 21  
 pico 349  
 piezoelectricity 186  
 pigeons 106  
 ping-pong ball 133  
 pinna 257  
 Pioneer satellites 77  
 Pisces 173  
 planet 96  
 planet-Sun friction 96  
 planetoids 163, 210, 211  
 plants 28  
 plate tectonics 125  
 play 21  
 pleural cavity 270, 397  
*Pleurotya ruralis* 82  
 plumb-line 55  
 Pluto 173  
 pneumothorax 397  
 point mass 79  
 point particle 79  
 point, mathematical 47  
 point-like for the naked eye  
   80  
 points 32, 80  
 poisons 28  
 Poisson equation 150  
 polar motion 124  
 Polaris 211  
 polarization 241  
 pollutants 397  
 pollution 397  
 pool filled with corn starch  
   and water 329  
 pop 378  
 Pororoca 254  
 Porpoise Cove 39

## P

## POSITIONAL

- positional system 341  
 positions 73  
 positivity 94  
 positron charge 354  
 possibility of knots 47  
 postcard 57  
 potassium 250, 315  
 potential energy 150  
 potential, gravitational 148  
 power, humorous definition of 392  
 power, physical 99, 183  
 ppm 398  
 pralines 279  
 praying effects 211  
 precession 127  
 precession of a pendulum 118  
 precession, equinoctial 122  
 precision 17, 29, 33, 68, 333, 352  
   limits to 353  
 predictability of motion 331  
 prefixes 349, 431  
 prefixes, SI 349  
 preprints 361, 362  
 pressure 184, 269, 301  
 principle of gauge invariance 220  
 principle of least action 114, 152, 204  
 principle of relativity 220, 367  
 principle of the straightest path 189  
 principle of thermodynamics second 298  
 principle, extremal 199  
 principle, variational 199  
 prism 411  
 prize, one million dollar 275  
 problems, physical 362  
 process, sudden 193  
 processes 298  
 Procyon 211  
 prodigies, calculating 341  
 product, dyadic 342  
 product, outer 342  
 pronunciation, Erasmian 339  
 proof 33  
 propeller 378  
 propellers in nature 81  
 proper time 40  
 proper velocity 34  
 properties, emergent 325  
 properties, intrinsic 26  
 properties, permanent 26  
 proton age 39  
 proton–electron mass ratio 355  
 pseudovector 133  
 PSR 1257+12 211  
 PSR 1913+16 39  
 psychokinesis 21  
 pulley 186  
 pulsar period 39  
 pulse 243  
 pyramid 101  
 Pythagoras' theorem 61
- Q**  
 Q-factor 234  
 qoppa 338  
 quanti, piccolissimi 265  
 quantities 225  
   conserved 16  
 quantity of matter 89, 94  
 quantity, extensive 95  
 quantum mechanics 182  
 quantum of entropy 307  
 quantum of information 307  
 quantum theory 25, 267  
 quartets 223  
 quartz 236  
 quasar 209  
 quietness of mornings 255  
 quotations, mathematical 364
- R**  
 R-complex 406  
 radian 62, 348  
 radiation 87, 300  
 radiation thermometry 425  
 radio speed 34  
 rain drops 72, 188  
 rain speed 34  
 rainbow 225  
 random 192  
 random errors 352  
 random pattern 24  
 randomness 192  
 rank 226  
 Ranque–Hilsch vortex tube 316  
 rattleback 134  
 ravioli 135  
 ray form 175  
 real numbers 41, 47  
 recognition 24  
 recognize 23  
 reduced Planck constant 354  
 reducible 223  
 reed instruments 246  
 reel 17  
 reflection of waves 240  
 refraction 213, 241  
 refractive index 213  
 Regulus 211  
 relations 26  
 relativity 195  
 relativity, Galileo's principle of 131  
 reluctance to turn 101  
 representation 222  
 representation of the observables 226  
 representations 221  
 reproducibility 219  
 research 189  
 research in classical mechanics 331  
 resources 361  
 rest 16  
 rest, Galilean 74  
 Reuleaux curves 367  
 reversibility of motion 192  
 reversible 298  
 Reynolds number 328  
 Rhine 283  
 rhythmites, tidal 414  
 Richter magnitude 134  
 riddle 15  
 Rigel 211  
 right-hand rule 99  
 ring laser 414  
 rings, astronomical, and tides 162  
 road, corrugated or washboard 321

## R

## ROADRUNNER

- Roadrunner 285  
 robot 420  
 robot juggling 72  
 robot, walking 214  
 robots walking on water 139  
 Roche limit 392  
 rock magnetization 125  
 rocket launch sites 132  
 rocket motor 186  
 roller coasters 180  
 rolling 105  
 rolling puzzle 30  
 rolling wheels 105  
 Roman number system 341  
 Rostock, University of 280  
 Roswell incident 256  
 rotation and arms 132  
 rotation change of Earth 121  
 rotation of the Earth 350  
 rotation rate 101  
 rotation sense in the athletic stadium 44  
 rotation speed 101  
 rotation, absolute or relative 132  
 rotational energy 103  
 roulette and Galilean mechanics 108  
 Rubik's Cube 256  
 rugby 98  
 Runic script 337  
 running backwards 310  
 running on water 415  
 running reduces weight 169  
 running speed record, human 70  
 Rydberg constant 332, 355
- S**  
 Sagarmatha, Mount 151, 283  
 Sagittarius 128, 173  
 Sagnac effect 120, 385  
 sailfish 34  
 sailing 95  
 sails 275  
*Salmonella* 82  
 sampi 338  
 san 338  
 sand 319  
 sand, Cuban 320  
 Saraeva 405  
 Sarcoman robot 72  
 satellite 80  
 satellite, artificial 80  
 satellites 135, 173  
 satellites, observable 363  
 Saturn 162, 173  
 scalar 73, 216, 225  
 scalar product 47, 73  
 scale 132, 286  
 scale invariance 267  
 scale symmetry 215  
 scaling law 43  
 Scorpius 173  
 screw 187  
 scripts, complex 340  
 sea wave energy 258  
 sea waves, highest 254  
 season 152  
 second 349, 357  
   definition 347  
 Sedna 173  
 selenite 54  
 self-adjoint 223  
 self-organization 198  
 self-similarity 51  
 sequence 38, 41, 47, 94  
*Sequoiadendron giganteum* 93  
 sets, connected 75  
 sex 14  
 sexism in physics 271  
 sextant 416  
 sexuality 148  
 sha 338  
 shadow of ionosphere 136  
 shadow of the Earth 136  
 shadow of the Earth during a lunar eclipse 143  
 shadows 86, 411  
 shadows and attraction of bodies 176  
 shadows of sundials 44  
 shampoo, jumping 284  
 shape 47, 79, 272  
 shape deformation and motion 81  
 shape of the Earth 172  
 sharp s 337  
 sheep, Greek 339  
 Shell study 412  
 shell, gravity inside matter 175  
 ship 93, 278  
 ship, wake behind 259  
 ships and relativity 130  
 ships, critical speed 254  
 shit 71, 410  
 shock waves 258  
 shoe size 351  
 shoelaces 47, 298  
 shore birds 415  
 short pendulum 383  
 shortest measured time 39  
 shot noise 269  
 shot, small 280  
 shoulders 106  
 shutter 61  
 shutter time 61  
 SI prefixes 352  
 SI units 347, 353  
   definition 347  
   prefixes 349  
   supplementary 348  
 siemens 349  
 sievert 349  
 similar 25  
 Simon, Julia 411  
 sine curve 234  
 singlets 223  
 singular 223  
 sink vortex 413  
 siren 253  
 Sirius 80, 211  
 situation 25  
 size 46  
 skateboarding 214  
 skew-symmetric 223  
 ski moguls 253, 320, 321  
 skin 81  
 skipper 72  
 sky, moving 122  
 slide rule 376  
 slingshot effect 169  
 Sloan Digital Sky Survey 363  
 small solar system bodies 211  
 smallest experimentally probed distance 60  
 smiley 343

## S

## SMOKE

- smoke 303
- snake constellation 173
- snap 378
- snowflake speed 34
- snowflakes 427
- soap bubbles 282
- sodium 250, 295, 315, 408
- solar data 363
- solar system 210
- solar system formation 122
- solar system simulator 363
- solar system, future of 177
- solitary waves 251
- soliton 252
- solitons 251
- sonar 260
- sonic boom 258
- sonoluminescence 84
- soul 108
- sound channel 255, 256
- sound speed 34
- source term 150
- sources 150
- South Pole 151
- south-pointing carriage 196
- space 334
- space is necessary 48
- space lift 285
- space points 80
- space travel 132
- space, absolute 118
- space, absoluteness of 47
- space, physical 46
- space, relative or absolute 48
- space, white 343
- space-time 26
- space-time diagram 70
- space-time, Galilean 67
- space-time, relative or absolute 48
- spatial inversion 227
- special relativity before the age of four 220
- specific mechanical energy 378
- spectrum, photoacoustic 314
- speed 74
  - of light  $c$
  - physics and 8
- speed of light inside the Sun 34
- speed of sound 91, 121
- speed, highest 34
- speed, infinite 335
- speed, lowest 29
- sperm motion 34
- Spica 211
- spin groups 215
- spinors 225
- spirituality 194
- split personality 193
- sponsor
  - this free pdf 9
- spoon 134
- spring 234
- spring constant 234
- spring tides 162
- sprinting 139
- squark 433
- St. Louis arch 376
- stadia 44
- stainless steel 287
- staircase formula 139
- stairs 44
- stalactite 286
- stalagmites 34
- stalagmites 326
- standard apple 352
- standard clock 170
- standard deviation 333, 352
- standard kilogram 89, 112
- standard pitch 235
- standing wave 243
- star age 39
- star classes 211
- stargazers 363
- stars 79, 211
- state 26, 190
- state allows one to distinguish 26
- state of an mass point, complete 190
- state of motion 25
- state space diagram 70
- state, initial 190
- state, physical 25
- states 26, 334
- static friction 187, 189
- stationary 204
- stationary fluid motion 273
- statistical mechanics 197
- steel 286
- steel, stainless 287
- Stefan–Boltzmann constant 355
- Steiner’s parallel axis theorem 103
- steradian 62, 348
- sticking friction 187
- stigma 338
- Stirling’s formula 313
- stones 23, 38, 69, 73, 79, 95, 116, 134, 142, 143, 145, 167, 169, 179, 243, 256, 298
- straight line, drawing a 196
- straight lines in nature 54
- straightness 46, 55, 59
- streets 386
- strong coupling constant 354
- structure, highest human-built 49
- subgroup 221
- submarines 256
- subscripts 339
- Sun 93, 96, 175, 211
- Sun density and tides 162
- Sun size, angular 63
- Sun will indeed rise tomorrow 152
- Sun’s age 356
- Sun’s luminosity 356
- Sun’s mass 356
- Sun, stopping 285
- Sun–planet friction 96
- sunbeams 368
- sundial 42, 408
- sundials 40, 44
- superboom 258
- supercavitation 277
- superfluidity 281
- supergiants 211
- superlubrication 187
- supermarket 44
- supernovae 84
- superposition 241
- support
  - this free pdf 9

## S

## SURFACE

- surface 46
  - surface tension 188
  - surface tension waves 239
  - surfing 254
  - surjective 223
  - surprises 193, 228
  - swan, wake behind 259
  - swarms 330
  - swimming speed underwater 277
  - swimming, olympic 255
  - Swiss cheese 263
  - switching off the lights 244
  - syllabary 340
  - symbols 341
  - symbols, mathematical 341
  - symmetry 220
  - symmetry of the whole
    - Lagrangian 226
  - symmetry operations 220
  - symmetry, external 220
  - symmetry, low 215
  - symmetry, summary on 232
  - Système International
    - d'Unités (SI) 347
  - system, geocentric 175
  - system, heliocentric 175
  - system, isolated 300
  - systematic errors 353
  - systems, conservative 150
  - systems, dissipative 189
  - systems, simple 325
- T**
- Talitrus saltator* 43
  - tantalum 39
  - Taurus 173
  - tax collection 347
  - teapot 281
  - technology 341
  - tectonic activity 156
  - tectonics 415
  - teeth growth 318
  - telekinesis 211
  - telephone speed 34
  - teleportation 95
  - telescope 254
  - television 23
  - temperature 291, 292
  - temperature scale 425
  - temperature, absolute 292
  - temperature, lowest in universe 295
  - temperature, negative 295, 317
  - tensor 225, 226
  - tensor order 226
  - tensor product 342
  - Tera 349
  - tesla 349
  - testicle 411
  - testimony 411
  - tetrahedron 60, 101
  - thermal energy 296
  - thermoacoustic engines 316
  - Thermodevices 294
  - thermodynamic degree of freedom 310
  - thermodynamics 296
    - second principle 298
  - thermodynamics, first 'law' of 99
  - thermodynamics, first principle 296
  - thermodynamics, indeterminacy relation of 307
  - thermodynamics, second 'law' of 99
  - thermodynamics, second principle of 314
  - thermodynamics, third principle 293
  - thermodynamics, zeroth principle 292
  - thermometer 294
  - thermometry 425
  - thermostatics 296
  - third, major 247
  - third, minor 247
  - thorn 337, 429
  - thriller 206
  - throw 23
  - throw, record 49
  - throwing speed, record 34, 58
  - throwing, importance of 23
  - thumb 63
  - tidal acceleration 162
  - tides 116, 156, 160, 414
  - tides and friction 163
  - tides, once or twice per day 179
  - time 25, 38, 334, 335
    - flow of 45
  - time intervals 41
  - time is deduced by comparing motions 39
  - time is necessary 41
  - time is what we read from a clock 40
  - time measurement, ideal 40
  - time translation 227
  - time travel 130
  - time, absolute 41
  - time, absoluteness of 41
  - time, arrow of 45
  - time, definition of 228
  - time, relative or absolute 48
  - time-bandwidth product 249
  - Titius's rule 177
  - TNT energy content 355
  - Tocharian 410
  - toilet research 327
  - tokamak 295
  - tonne, or ton 349
  - topology 47
  - torque 103
  - total momentum 90
  - touch 86
  - toys, physical 363
  - train 93
  - trajectory 68
  - transformation 19
  - transformations 220
  - transforms 96
  - translation invariance 41, 47
  - transport 19
  - transubstantiation 265
  - tree 352
    - family 26
  - tree growth 34
  - tree height, limits to 267
  - tree leaves and Earth rotation 120
  - trees 267
  - trees and pumping of water 423



# T

## TRIBOSCOPES

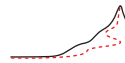
- triboscopes 189
  - tripod 186
  - tritone 247
  - Trojan asteroids 159
  - tropical year 355
  - truth 266
  - tsunami 240
  - tuft 425
  - tumbleweed 81
  - tunnel through the Earth 179
  - turbulence 275, 325, 331
  - turbulence in pipes 328
  - Turkish 337
  - two-dimensional universe 66
  - Tycho Brahe 152
  - Tyrannosaurus rex* 138
- U**
- udeko 349
  - Udekta 349
  - UFOs 256
  - ultrasound imaging 247
  - ultrasound motor 186
  - umbrella 71
  - unboundedness 35, 41, 47, 225
  - unboundedness, openness 94
  - uncertainty
    - total 353
  - uncertainty relation of
    - thermodynamics 307
  - underwater swimming 277
  - underwater, speed records 277
  - Unicode 340
  - unicycle 288
  - uniqueness 41, 47
  - unit 300, 347
  - unitary 223
  - units 47
    - non-SI 350
    - provincial 350
  - units, astronomical 356
  - units, SI
    - definition 347
  - universal 'law' of gravitation
    - 142
  - universal 'law' of gravity 143
  - universal time coordinate 40, 350
  - universality of gravity 159
- V**
- universe 26, 191
  - universe, description by
    - universal gravitation 171
  - universe, two-dimensional 66
  - Universum 294
  - unpredictability, practical 192
  - URL 361
  - usenet 361
  - UTC 40
- V**
- vacuum permeability 354
  - vacuum permittivity 354
  - vacuum wave resistance 355
  - vacuum, human exposure to
    - 132
  - variability 23
  - variable 25
  - variance 352
  - variation 25
  - variational principle 204
  - variational principles 195
  - Varuna 210
  - vector 73, 225
  - vector product 99
  - vector space 73
  - vector space, Euclidean 74
  - Vega 211
  - Vega at the North pole 122
  - velars 338
  - velocimeters 367
  - velocity 33, 74, 238, 335
  - velocity as derivative 75
  - velocity in space 35
  - velocity is not Galilean 35
  - velocity of birds 35
  - velocity, escape 171
  - velocity, Galilean 33
  - vendeko 349
  - Vendekta 349
  - Venturi gauge 275
  - vernier 59
  - video recorder 307
  - Vietnam 179
  - viewpoint-independence 216
  - viewpoints 215
  - Virgo 173
  - vis viva 96
  - viscosity, kinematic 328
- W**
- viscous 188
  - vocal cords 246
  - void 271
  - volcanoes 415
  - volt 349
  - volume 53
  - voluntary motion 187, 191
  - vortex in bath tub or sink 413
  - vortex rings 284
  - vortex tube 316
  - vortices 276
  - Vulcan 160
  - Vulcanoids 211
- W**
- wafer, consecrated 272
  - wafer, silicon 272
  - wake angle 259
  - wake behind swans and ships
    - 259
  - walking 106, 298
  - walking robots 214
  - walking speed 146
  - walking speed, maximum
    - animal 388
  - wallpaper groups 217
  - washboard roads 321
  - water 423
  - water strider 138
  - water taps 325
  - water waves 239, 261
  - water waves, group velocity of
    - 255
  - water, speed records under
    - 277
  - water-walking robots 139
  - watt 349
  - wave reflection 240
  - wave, harmonic 238
  - wave, linear 238
  - wavelength 238, 242
  - wavelet transformation 258
  - waves, deep 239
  - waves, in deep water 259
  - waves, long 239
  - waves, longitudinal 238
  - waves, shallow 239
  - waves, short 239
  - waves, transverse 238

# W

---

WAVES

- waves, water 239, 261  
 waw 338  
 weak mixing angle 354  
 weather 329  
 weather, unpredictability of 192  
 web cam, Foucault's pendulum 117  
 web, largest spider 49  
 weber 349  
 week 344  
 week days, order of 178  
 Weib 410  
 weight 165, 184  
 weight of the Moon 177  
 weightlessness, feeling of 389  
 weko 349  
 Wekta 349  
 well-tempered intonation 247  
 whale, blue 253  
 whales 173, 256, 257  
 wheel axle, effect of 378  
 wheel ultimate 22  
 wheels in living beings 81  
 wheels in nature 82  
 whip cracking 287  
 whip, speed of 34  
 whirl 129  
 white colour does not last 299  
 Wien's displacement constant 355  
 wife 410  
 Wikimedia 294  
 wind resistance 188  
 wine 265  
 wine arcs 326  
 wine bottle 95, 110  
 wings 275  
 Wirbelrohr 316  
 wise old man 206  
 WMAP 389  
 wobblestone 134  
 women 157, 410  
 women, dangers of looking after 137  
 work 97, 204  
 work, physical 184  
 world 14, 26  
 World Geodetic System 357, 417  
 world question center 364  
 world-wide web 361  
 writing 336  
 wrong 333  
 wyn 337
- ## X
- xenno 349  
 Xenta 349
- ## Y
- year, number of days 163  
 yo-yo 145  
 yocto 349  
 yogh 337  
 yot 338  
 Yotta 349
- ## Z
- zenith 134  
 zenith angle 143  
 zepto 349  
 zero 341  
 zero gravity 389  
 Zetta 349  
 zippo 325  
 zodiac 152

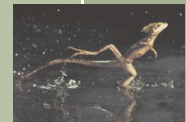


# MOTION MOUNTAIN

## The Adventure of Physics – Vol. I

### Fall, Flow and Heat

Why do change and motion exist?  
How does a rainbow form?  
What is the most fantastic voyage possible?  
Is 'empty space' really empty?  
How can one levitate things?  
At what distance between two points does it become  
impossible to find room for a third one in between?  
What does 'quantum' mean?  
Which problems in physics are unsolved?



Answering these and other questions on motion, this series gives an entertaining and mind-twisting introduction into modern physics – one that is surprising and challenging on every page.

Starting from everyday life, the adventure provides an overview of the recent results in mechanics, thermodynamics, electrodynamics, relativity, quantum theory, quantum gravity and unification. It is written for undergraduate students and for anybody interested in physics.

Christoph Schiller, PhD Université Libre de Bruxelles, is a physicist with more than 25 years of experience in the presentation of physical topics.

Pdf file available free of charge at  
[www.motionmountain.net](http://www.motionmountain.net)

