

# Looking for charged detector- stable particles at the LHC

Vasiliki A. Mitsou

*Trisbram Ellis Corfu 1905.*



23<sup>rd</sup> HELLENIC SCHOOL AND WORKSHOPS ON ELEMENTARY PARTICLE PHYSICS AND GRAVITY  
Workshop on the Standard Model and Beyond  
August 27 - September 7, 2023, Corfu, Greece

# Lifetime frontier

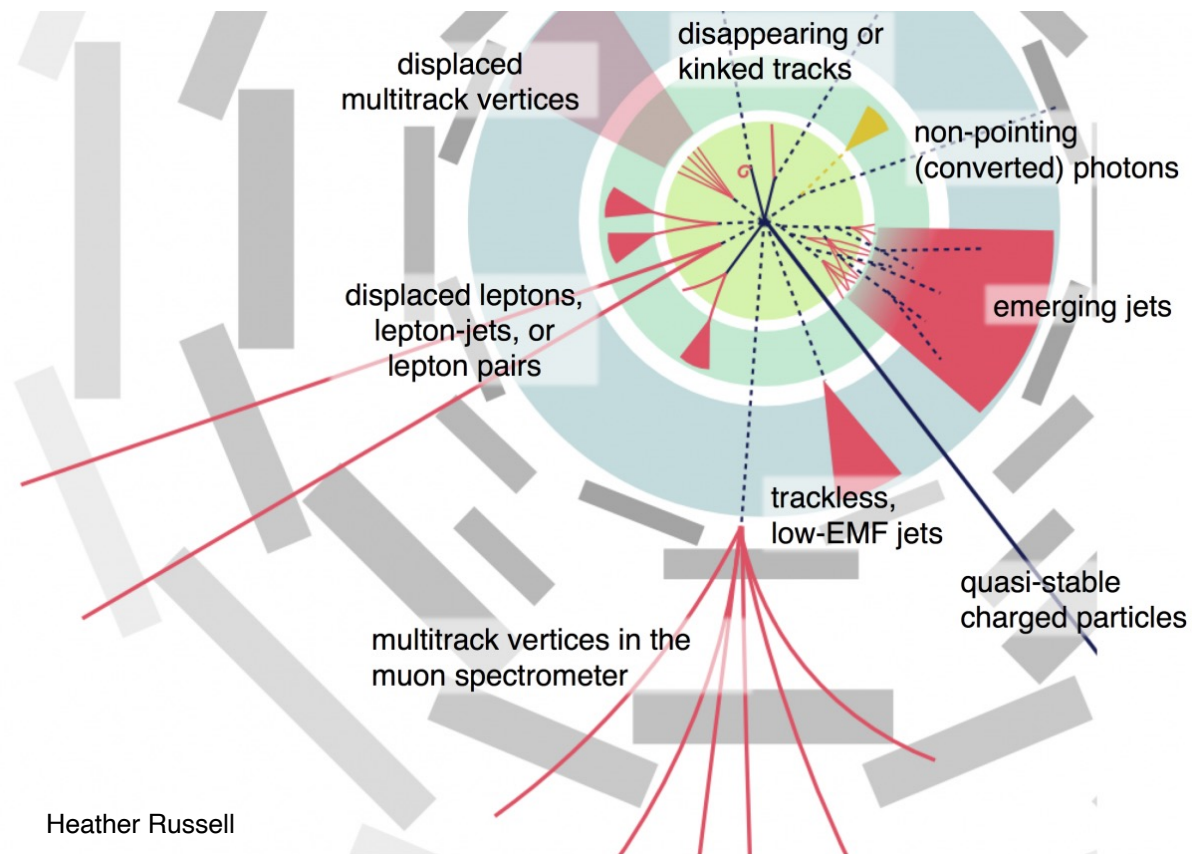

- Physics beyond the Standard Model has not appeared in searches so far
- Maybe we are not looking at the right signals
- **Long-lived particles may be the answer**

# Lifetime frontier

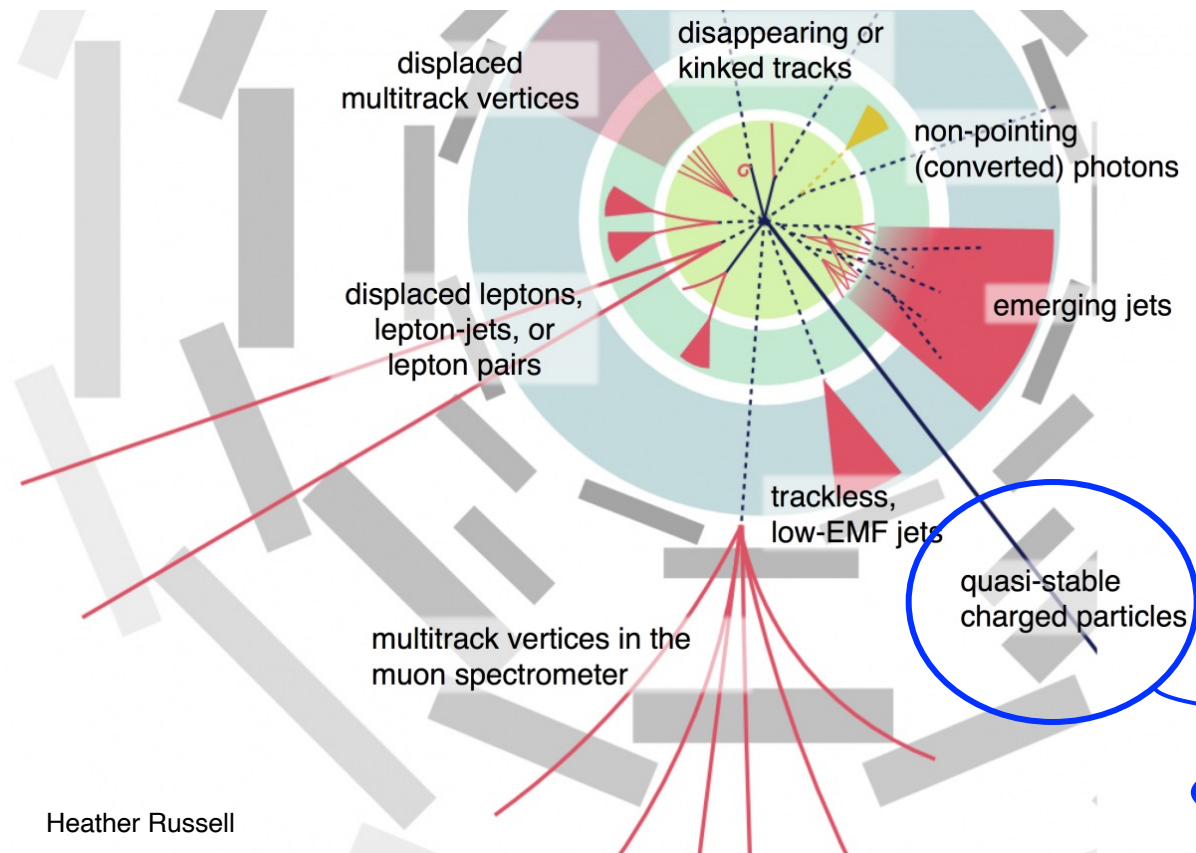

- Physics beyond the Standard Model has not appeared in searches so far
- Maybe we are not looking at the right signals
- **Long-lived particles may be the answer!**

focus of this talk

# High ionisation

**Highly ionising particles (HIPs)** characterised by one *or both* of these properties:

- high charges (**high z**) ⇒ **electric** and/or **magnetic** charges
- slow moving (**low β**) ⇒ **massive** particles

$$-\frac{dE}{dx} = K z^2 \frac{Z}{A} \frac{1}{\beta^2} \left[ \frac{1}{2} \ln \frac{2m_e c^2 \beta^2 \gamma^2 T_{\max}}{I^2} - \beta^2 - \frac{\delta}{2} \right]$$

Electric charge – Bethe-Bloch formula

Figure of merit for large energy loss:  $z/\beta$

$$-\frac{dE}{dx} = K \frac{Z}{A} g^2 \left[ \ln \frac{2m_e c^2 \beta^2 \gamma^2}{I_m} + \frac{K |g|}{2} - \frac{1}{2} - B(g) \right]$$

Magnetic charge

Bethe-Ahlen  
formula

# Multiply charged quasi-stable particles

- High Electric Charge Objects (**HECOs**) predicted in many scenarios of physics beyond the SM
  - finite-sized objects (Q-balls)
  - condensed states (strangelets)
  - microscopic black holes (through their remnants)
  - ...
- They eventually decay into other particles

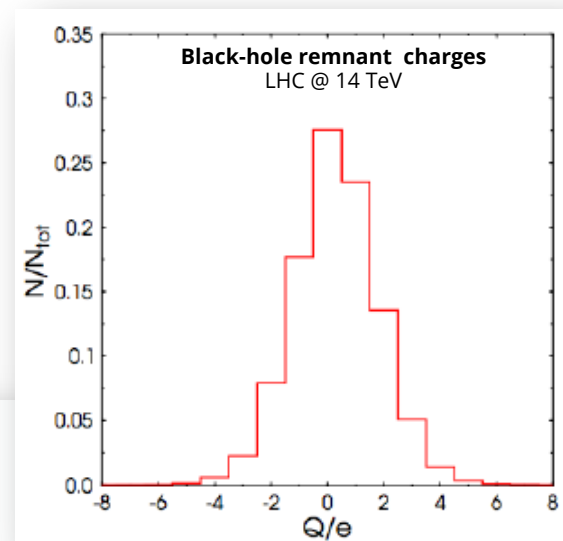
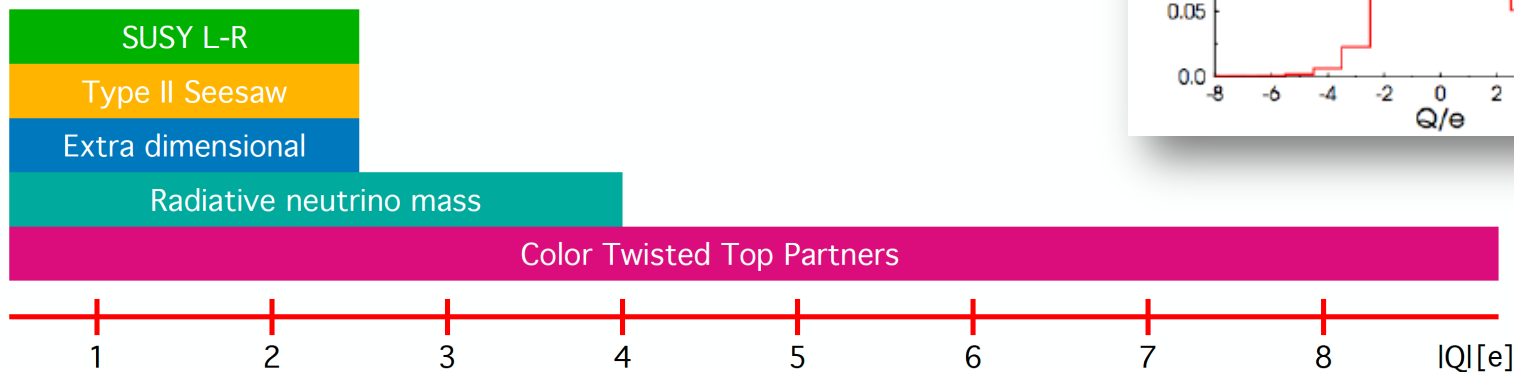

R. Maserik,  
DISCRETE2020-  
2021

Hossenfelder, Koch, Bleicher,  
[hep-ph/0507140](https://arxiv.org/abs/hep-ph/0507140)

# Magnetic monopoles in a nutshell

- Why? Because they symmetrise Maxwell's equations
  - electric  $\leftrightarrow$  magnetic charge duality
- Single magnetic charge (Dirac charge):  $g_D = 68.5e$ 
  - higher charges are integer multiples of Dirac charge:  $g = ng_D$ ,  $n = 1, 2, \dots$
  - > 4700 times more ionising than a minimum ionising particle!
- Photon-monopole coupling constant
  - large:  $g/\hbar c \sim 20$  (precise value depends on units)
- Dirac monopole is a *point-like* particle; GUT monopoles are *extended* objects
  - production of composite monopoles exponentially suppressed by  $e^{-4/\alpha}$
- Monopole **spin** is not determined by theory  $\rightarrow$  free parameter
- Monopole **mass** not theoretically fixed  $\rightarrow$  free parameter

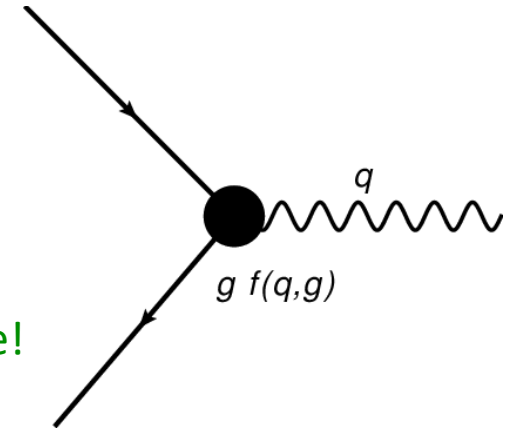

For a review on monopole theory and searches:  
Mavromatos & VAM, [Int.J.Mod.Phys.A 35 \(2020\) 2030012](https://arxiv.org/abs/2003.0012)

# Large Hadron Collider at CERN

- ATLAS and MoEDAL perform searches for magnetic monopoles & HECOS
- MoEDAL receives  $\sim 10$ – $50$  times less luminosity than ATLAS
- Complementarity
  - ATLAS general-purpose; based on electronic readout
  - MoEDAL dedicated to (meta)stable particles; mostly passive detectors

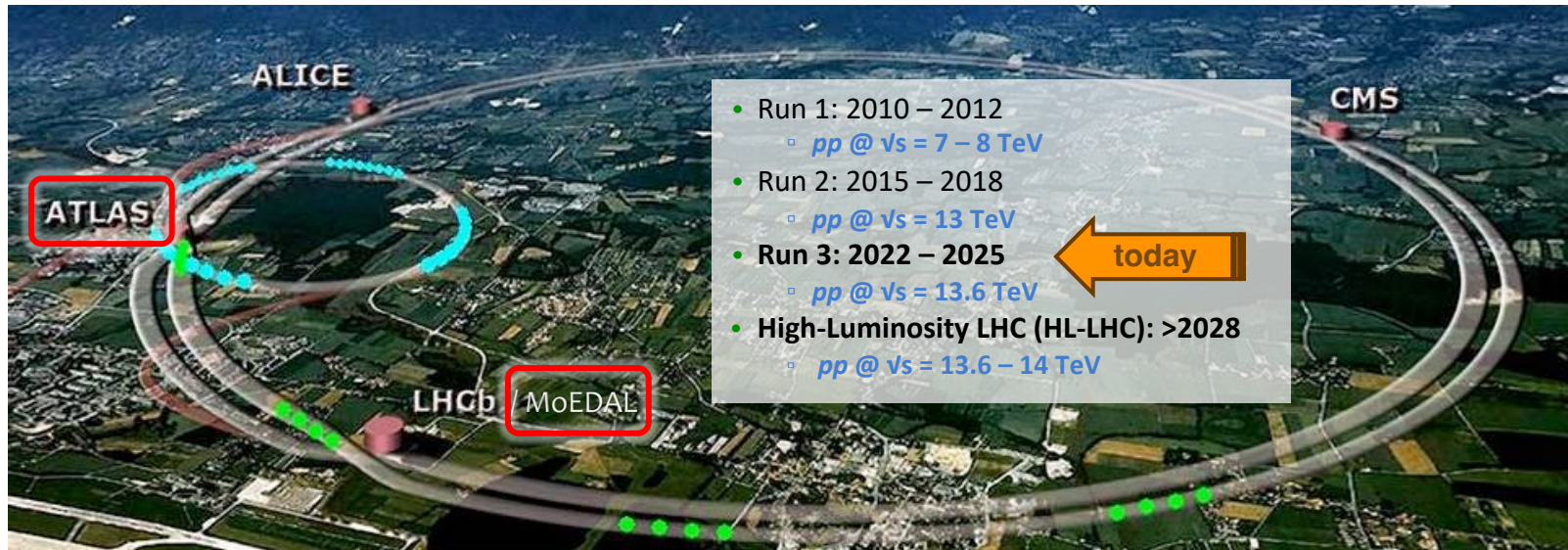



# ATLAS searches

- $dE/dx$  in pixel detector
- Large  $dE/dx$  + ToF
- Multiply charged particles
- Monopoles and HECOs

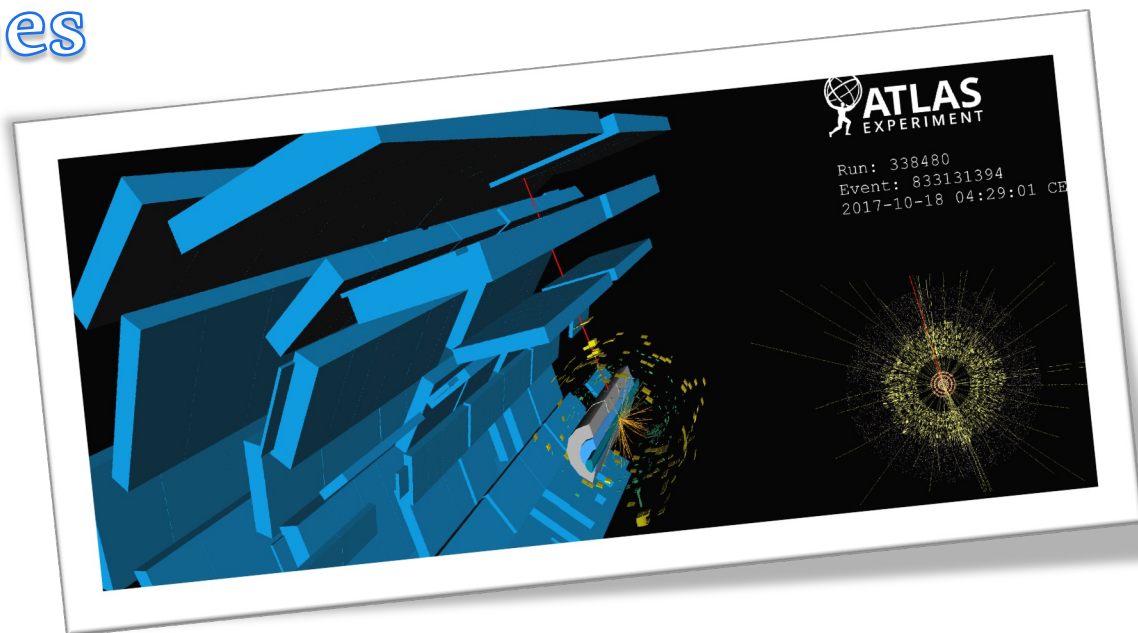

See also Xuai Zhuang's and Jun Guo's talks



# ATLAS sub-systems for HIP searches

1. Energy loss ( $dE/dx$ ) measurements
2. Timing information – Time-of-Flight (ToF)

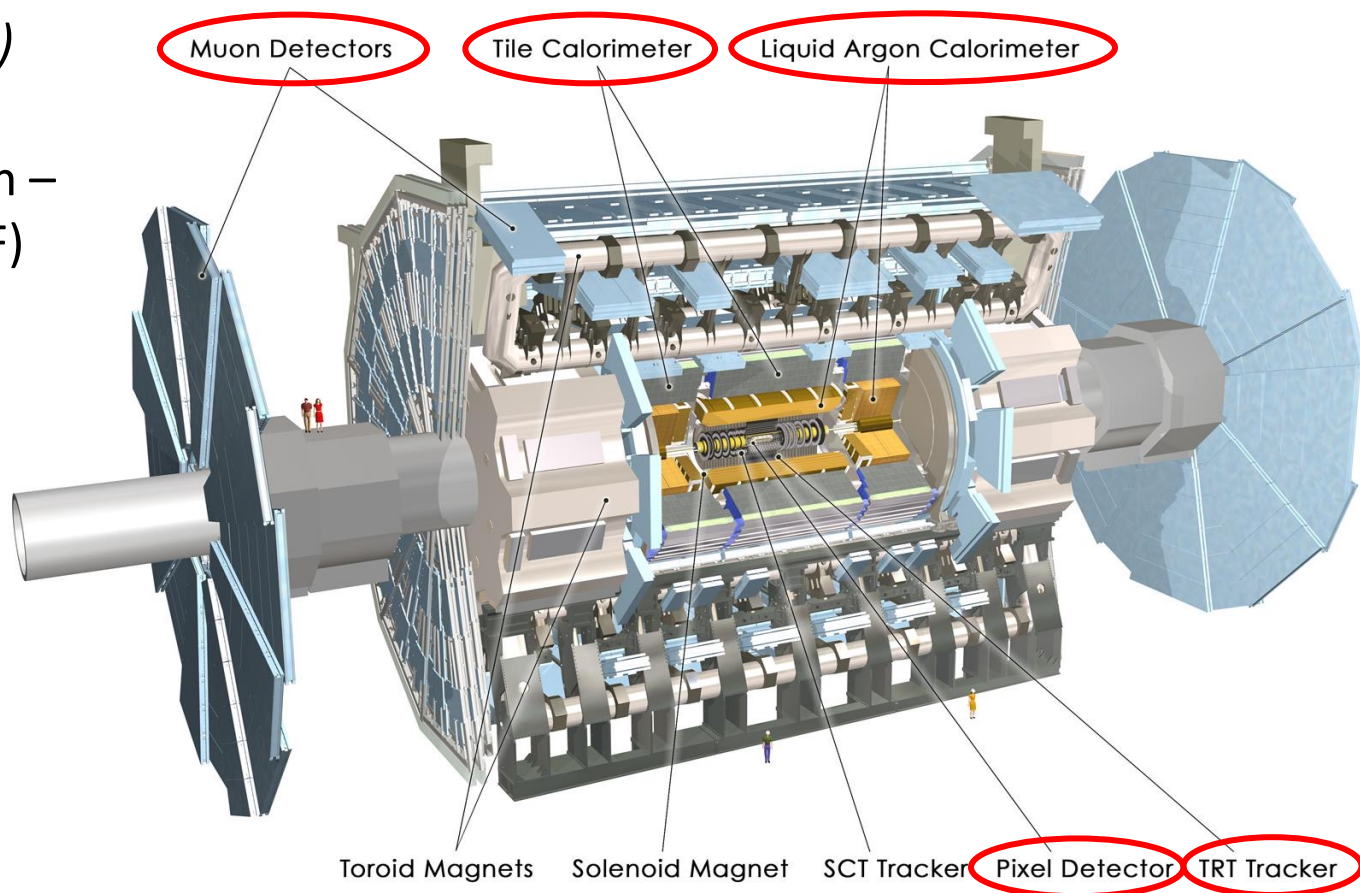

# 2022: $dE/dx$ in pixel detector

JHEP 06 (2023) 158



- Wide sensitivity to charged, long-lived, massive particles with lifetimes of  $\sim$ ns to stable  $\rightarrow$  gluinos, charginos, sleptons
- Pixel detector provides ionisation measurements ( $\sigma \approx 12\%$ ) along each track

Excess  $2.4\sigma$  in mass bin of 600 GeV gluino seen in  $36.1 \text{ fb}^{-1}$  search [[Phys. Lett. B 788 \(2019\) 96](#)] not confirmed

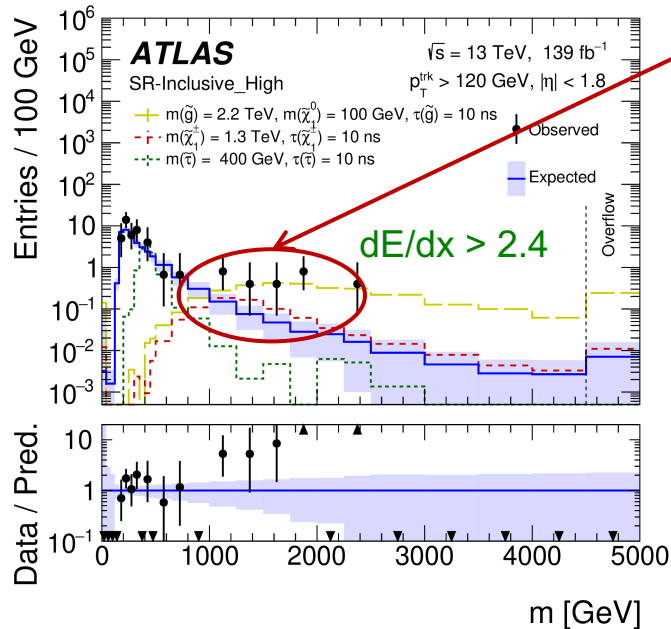

7 observed,  $0.7 \pm 0.4$  expected  
 $3.3\sigma$  global excess

$$m_{dE/dx} \equiv \frac{P_{\text{reco}}}{\beta\gamma \langle dE/dx \rangle_{\text{corr}}}$$

These 7 charged particles seen in calorimeter & muon systems, which estimate  $\beta \sim 1$   $\rightarrow$  inconsistent with signal model, if  $z = 1$

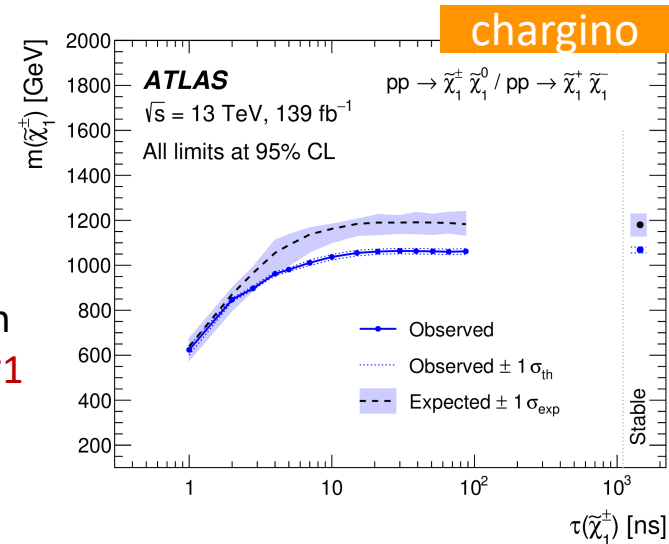

# Large $dE/dx + \text{ToF}$

- Targeting singly charged massive charged slow particles:  $m > 100 \text{ GeV}$ ,  $\tau > 3 \text{ ns}$
- Based on measurement of anomalously large ionisation **energy loss** in **ID tracker**
- Improves 2022 search [[JHEP 06 \(2023\) 158](#)] by **ToF** measured by **hadronic calorimeter**

ATLAS-CONF-2023-044

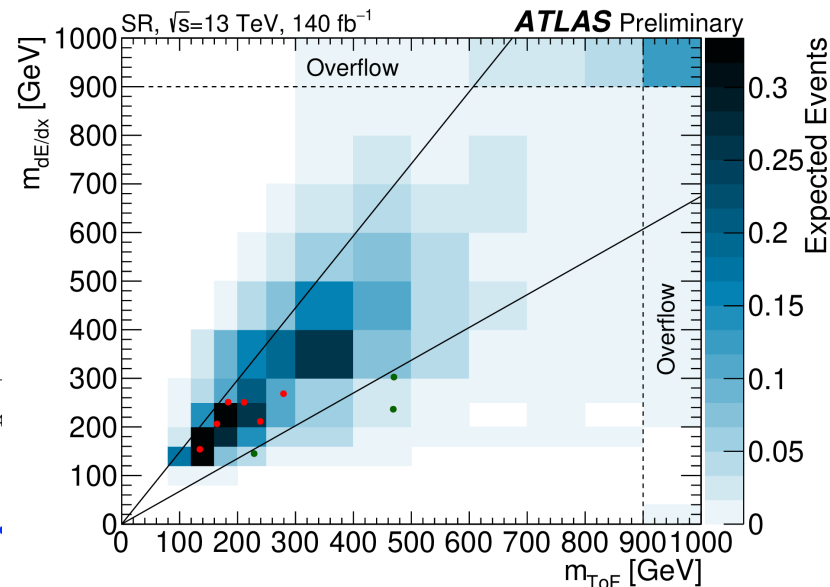

Agreement with background expectation

- observed 6 events in signal region
- expected  $5.1 \pm 0.5$  background events

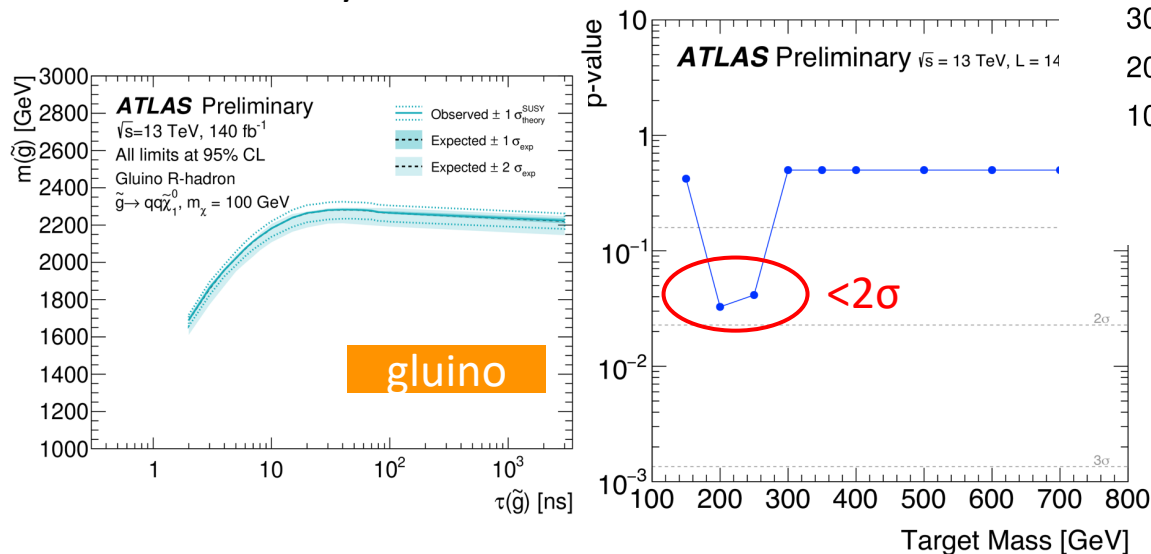

# Multiply charged particles

arXiv:2303.13613



- Searching heavy particles of charge  $2e \leq z \leq 7e$
- Detectors
  - Pixel, TRT, muon MDT  $\rightarrow dE/dx$
  - high-threshold TRT hits
- Pixel used only in  $z = 2$ ; saturated readout for higher  $z$

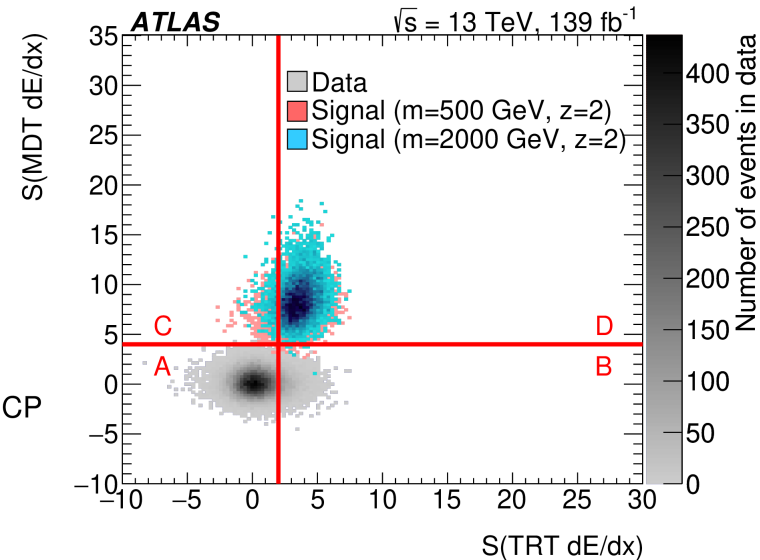
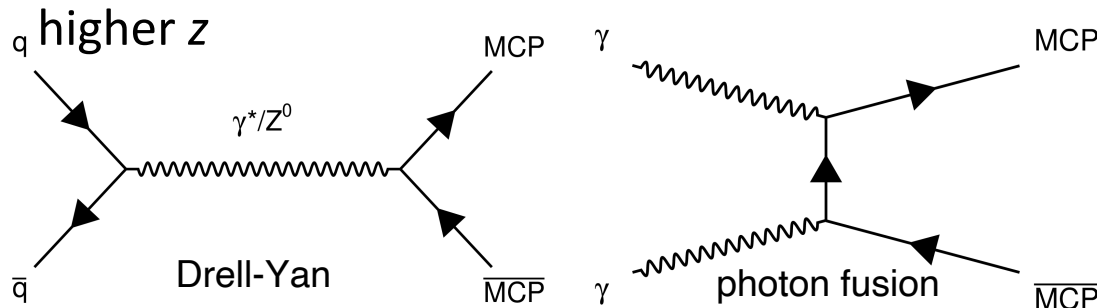

$$S(dE/dx) = \frac{dE/dx - \langle dE/dx \rangle_{\mu}}{\sigma(dE/dx)_{\mu}}$$

Search category	$N^A$ observed data	$N^B$ observed data	$N^C$ observed data	$N^D$ expected data	$N^D$ observed data
$z = 2$	41 674	5024	13	$1.6 \pm 0.4$ (stat.) $\pm 0.5$ (syst.)	4
$z > 2$	192 036 934	15 004	441	$0.034 \pm 0.002$ (stat.) $\pm 0.004$ (syst.)	0

**1.5 $\sigma$   
excess**

# Monopoles and HECOs

[arXiv:2308.04835](https://arxiv.org/abs/2308.04835)



- Two different signals:
  - TRT**: large high-threshold (HT) hit fraction,  $f_{HT}$ , due to HIP & associated  $\delta$ -electrons
  - EM calorimeter**: HIPs slow down (and usually stop) there, leaving a pencil-shape energy deposit, unlike extensive showers from (much lighter) electron

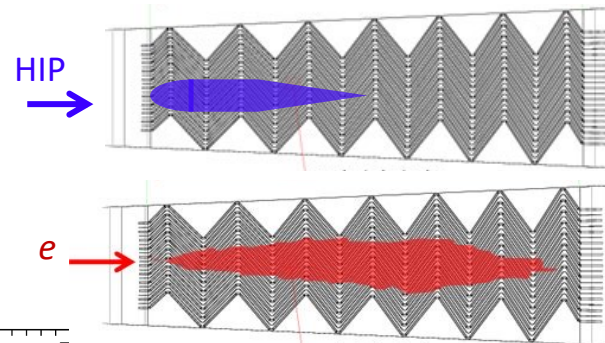

- No events observed in signal region A

$0.15 \pm 0.04$  (stat)  $\pm 0.05$  (syst)  
background events expected,  
estimated as

$$N_A^{\text{exp}} = N_B N_C / N_D \text{ (ABCD method)}$$

data / background

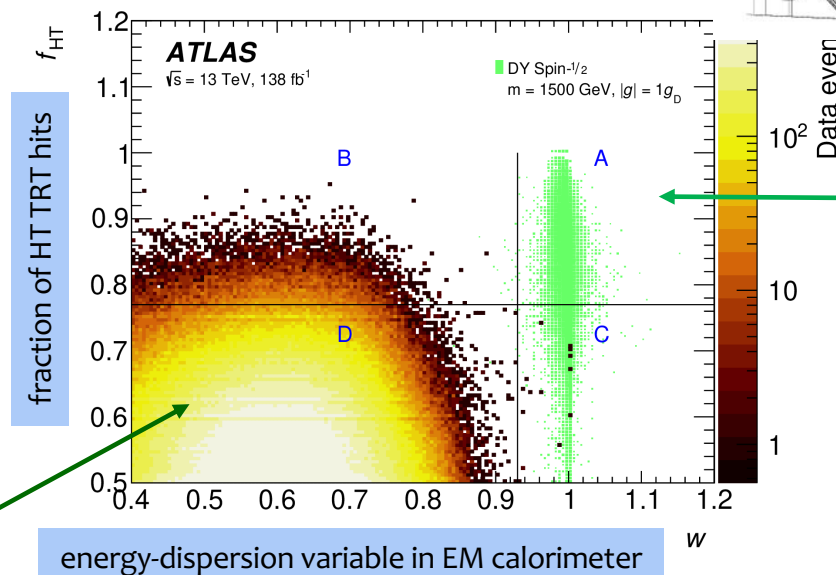

monopole  
signal

First ATLAS limits  
on  $\gamma\gamma$  fusion  
production of  
monopoles and  
HECOs

# MoEDAL results

- Magnetic monopoles – Drell-Yan & photon fusion
- Dyons
- Schwinger mechanism
- HECOs

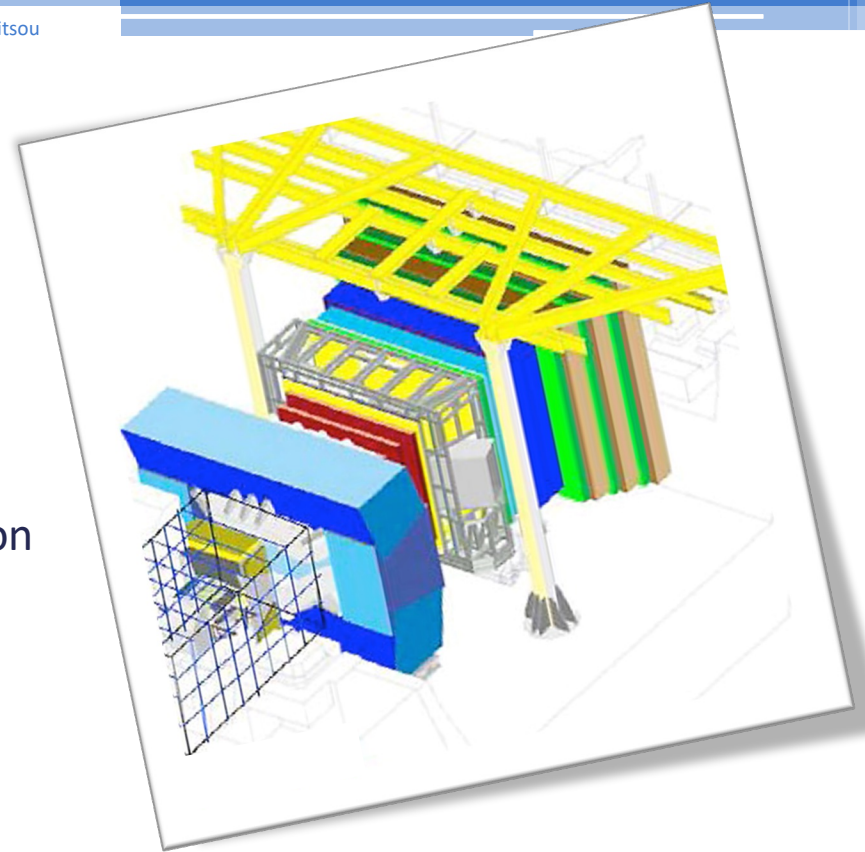

# MoEDAL – Monopole & Exotics Detector At LHC

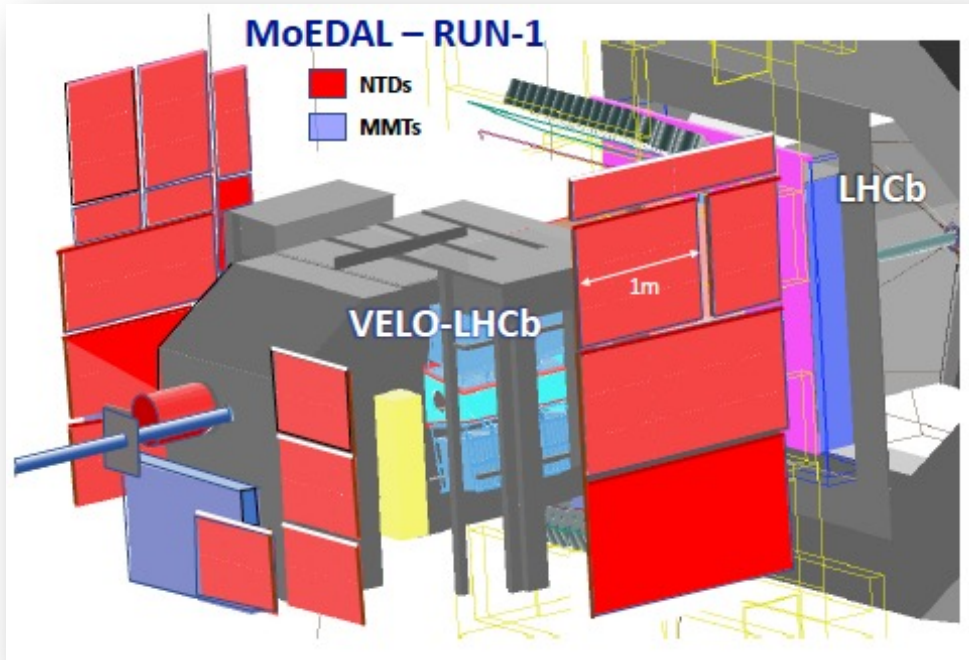

## DETECTOR TECHNOLOGIES

- ① Nuclear Track Detectors (NTD)
- ② Monopole Trapping detector (MMT) – aluminum bars
- ③ TimePix radiation background monitor

- Mostly **passive detectors**; no trigger; no readout
- Permanent physical record of new physics
- No Standard Model physics backgrounds

LHC's first dedicated *search* experiment  
(approved 2010)

MoEDAL physics program, [Int. J. Mod. Phys. A29 \(2014\) 1430050](#)

See also Jim Pinfold's talk

# MMT scanning

- Monopoles can bind to nuclei and get trapped
- MMTs analysed in superconducting quantum interference device (SQUID) at ETH Zurich
- **Persistent current:** difference between resulting current after and before
- Outliers are **scanned several times** further

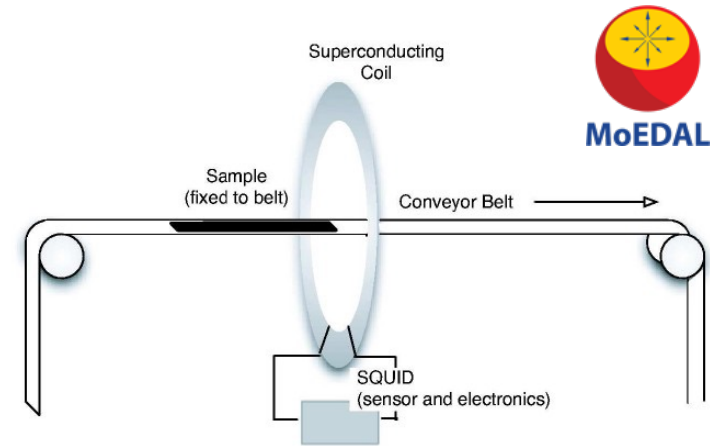

SQUID analysis – Persistent current after first two passages for all samples

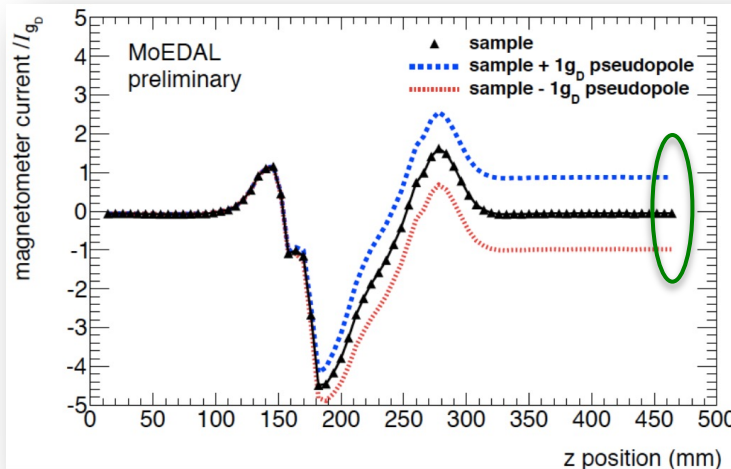

Calibration:  
Typical sample &  
pseudo-monopole  
curves

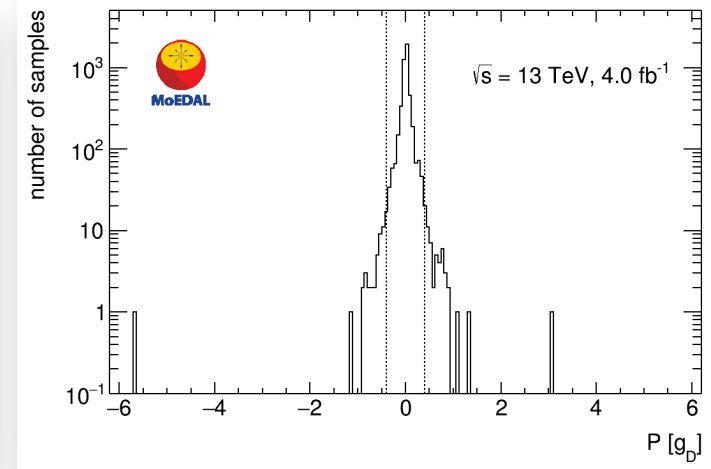



# Magnetic monopole limits

- Novelties in monopole models:  $\beta$ -dependent coupling, spin-1 monopoles,  $\gamma\gamma$  fusion
- MoEDAL set world-best collider limits for  $|g| > 2 g_D$
- ATLAS set best limits for  $|g| \leq 2 g_D$

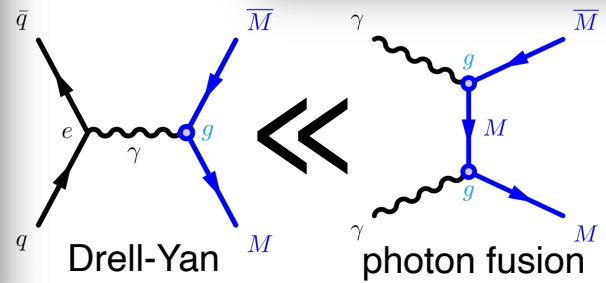
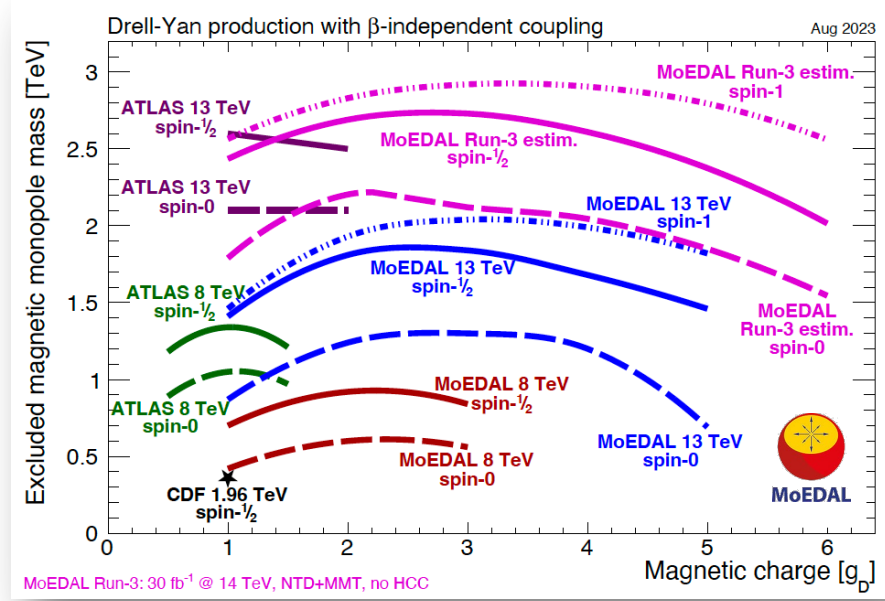
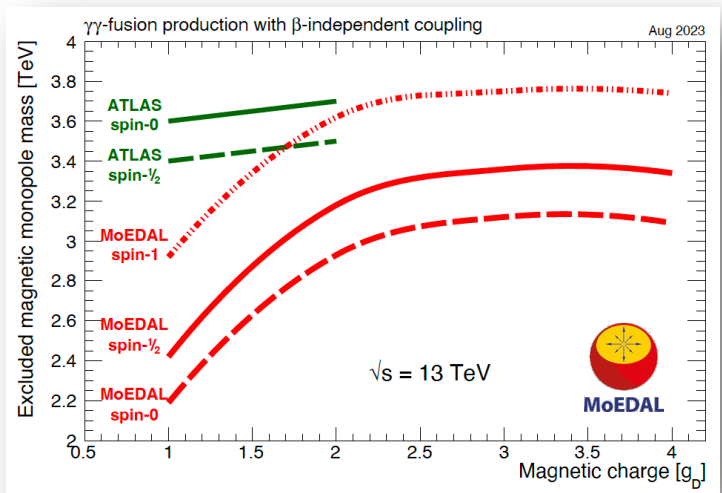

MoEDAL, [JHEP 1608 \(2016\) 067](#),  
[PRL 118 \(2017\) 061801](#),  
[PLB 782 \(2018\) 510](#),  
[PRL 123 \(2019\) 021802](#),  
[PRL 126 \(2021\) 071801](#)

See also, Baines, Mavromatos, VAM, Pinfeld, Santra, [Eur.Phys.J.C 78 \(2018\) 966](#)

Mass limits extracted with Feynman-like diagrams that ignore non-perturbativity of large monopole-photon coupling 

# Dyons: electric & magnetic charge



[Science 165 \(1969\) 757](#)

## A Magnetic Model of Matter

A speculation probes deep within the structure of nuclear particles and predicts a new form of matter.

Julian Schwinger

**SCIENCE**

- Predicted in GUT theories, string theories, ...
- MoEDAL MMT scanning searching for captured dyons

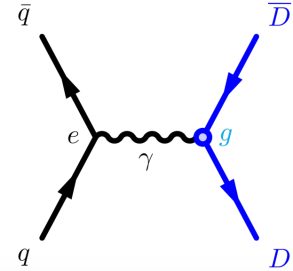

First explicit accelerator search for direct dyon production!



ABOUT NEWS

## MoEDAL hunts for dyons

The MoEDAL collaboration at CERN reports the first search at a particle accelerator for particles with both electric and magnetic charge

17 FEBRUARY, 2020 | By Ana Lopes

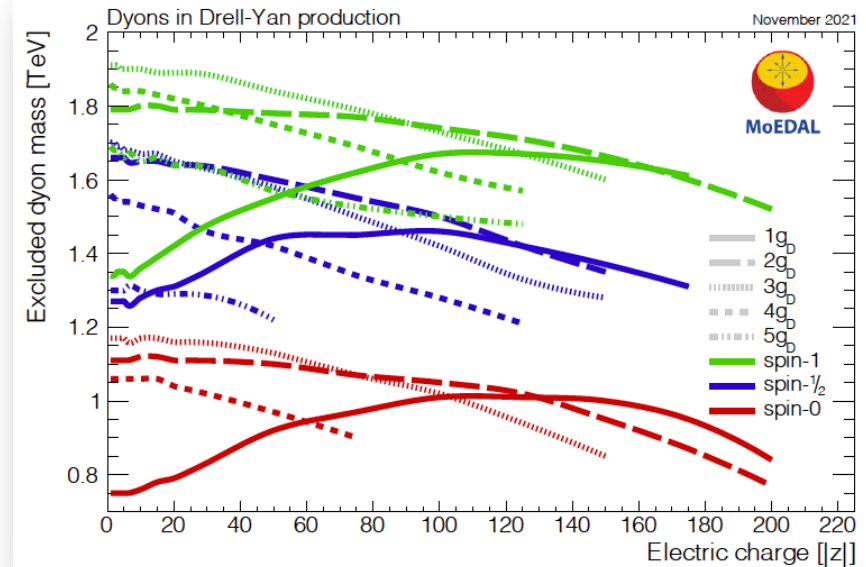

MoEDAL, [PRL 126 \(2021\) 071801](#)



# Monopoles via thermal Schwinger mechanism

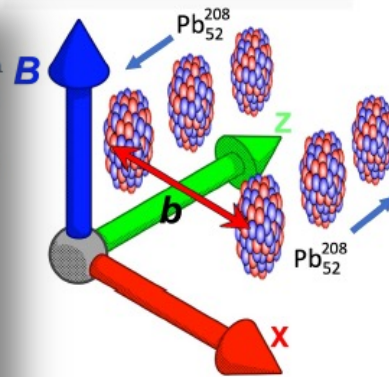
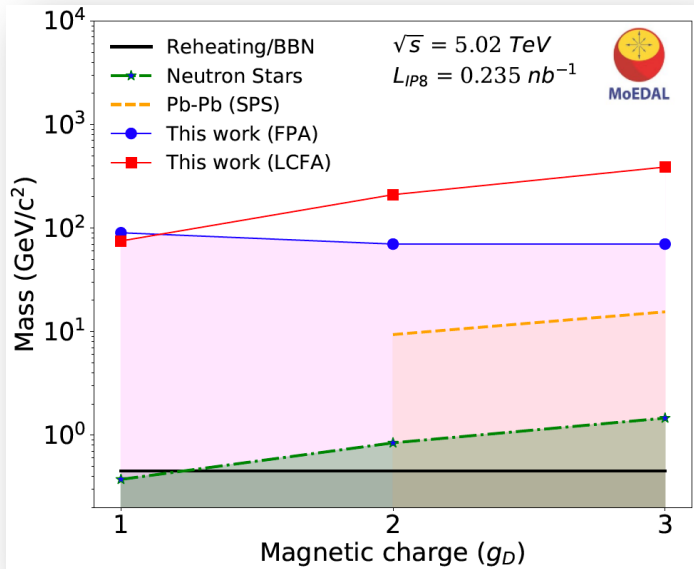

Limits on monopoles  
 of  $1 - 3 g_D$  and  
 masses up to  $75 \text{ GeV}$

Monopole-antimonopole pairs may be produced in strong magnetic fields present in heavy-ion collisions

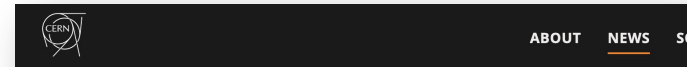

## MoEDAL bags a first

The MoEDAL experiment has conducted the first search at a particle collider for magnetic monopoles produced through the Schwinger mechanism

2 JULY, 2021 | By Ana Lopes



The MoEDAL experiment, seen here during installation in the LHC tunnel. (Image: CERN)

- First limits based on **non-perturbative** calculation of monopole production cross section
- First direct search sensitive to **finite-size** monopoles



MoEDAL, [Nature 602 \(2022\) 7895, 63-67](#)

# NTD analysis

- Passage of HIP through plastic NTD marked by *invisible* damage zone (“**latent track**”) along the trajectory
- Damage zone revealed as a **cone-shaped etch-pit** when plastic sheet **chemically etched** → in ethyl alcohol solution in INFN Bologna
- NTDs **scanned** to detect etch-pits with automatic scanning system
- Scanning efficiency for detection above threshold is **>99%**

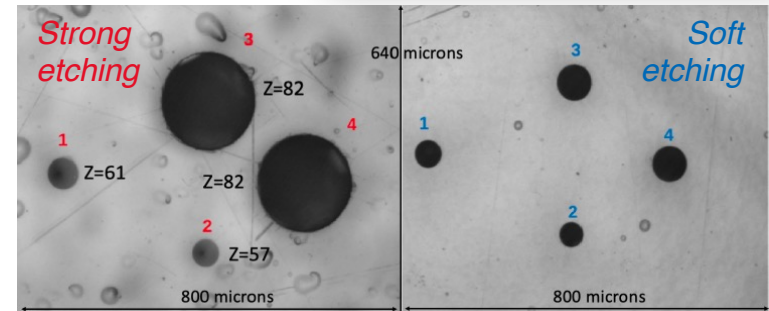
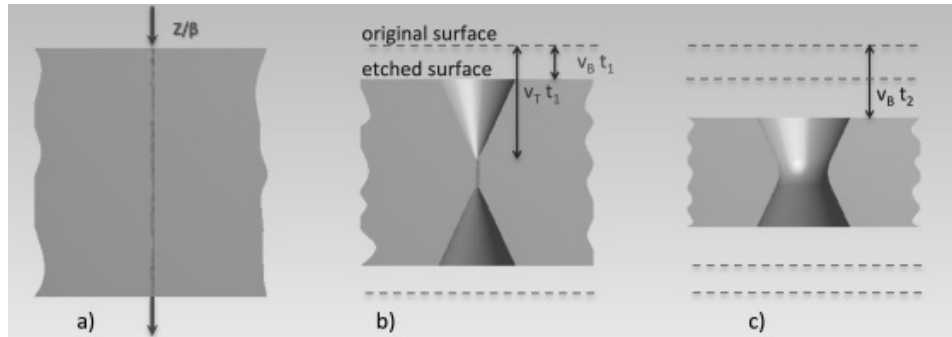
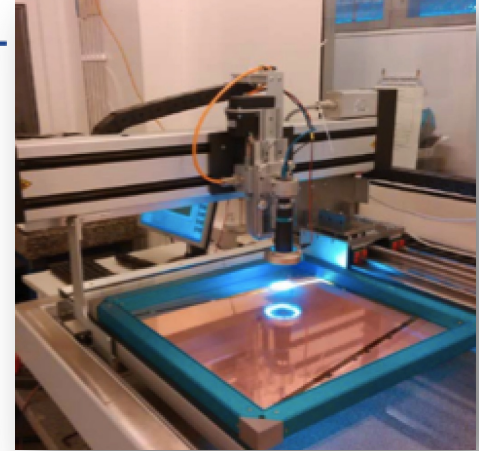

Calibration with  $\text{Pb}^{82+}$  and  $\text{Xe}^{54+}$  ion beams

No candidates found in the stacks examined

# HECOs results

- Limits on HECO with electric charges in the range  **$15e - 175e$**  and masses from  **$110 - 1020$  GeV**
- Upper limits on production cross section  $\sim$   **$30-70$  pb**
- **Better sensitivity achieved in soon-to-be-released Run 2 analysis**
  - higher c.m.s. energy: 13 TeV
  - larger integrated luminosity
  - larger exposed NTD surface
  - lower CR39 Z/ $\beta$  threshold than Macrofol

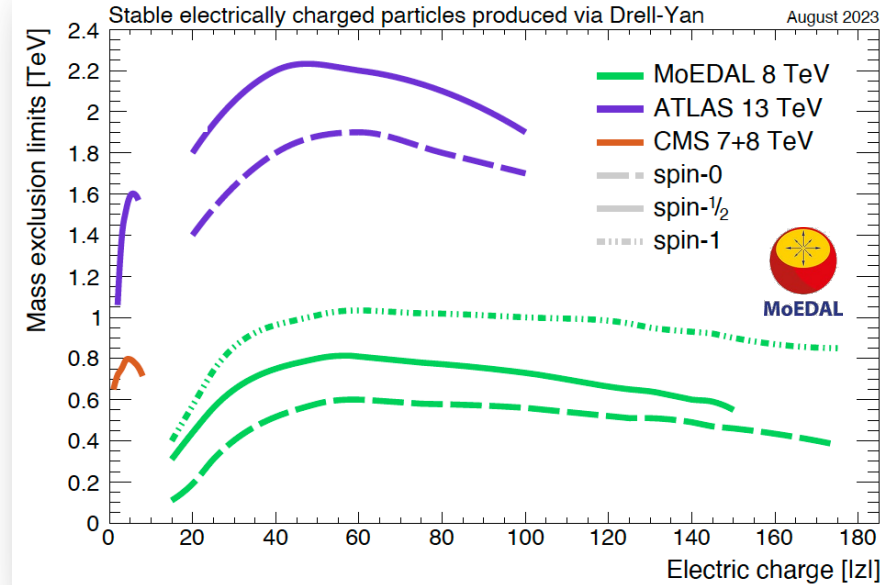

**Non-perturbativity of large coupling can be tackled by appropriate **resummation****

[Alexandre, Mavromatos, Musumeci, VAM, *LHCP2023 & paper in preparation*]

**MoEDAL HECO limits are the strongest to date, in terms of charge, at any collider experiment**

# Prospects for 'low' electric charges

- Supersymmetric long-lived particles
- Charges  $\sim 1e - 10e$

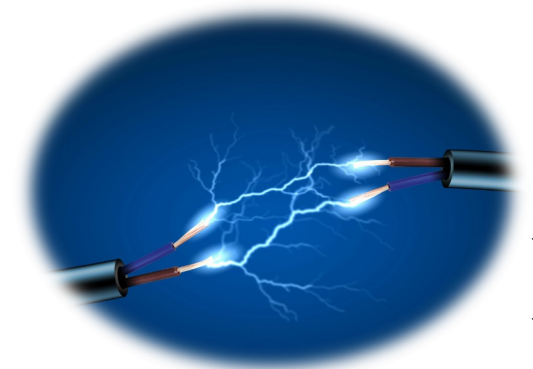

# Long-lived SUSY partners in MoEDAL

- Benchmark decay chain:  $\tilde{g}\tilde{g}$  production with  $\tilde{g} \rightarrow jj\tilde{\chi}_1^0$ ,  $\tilde{\chi}_1^0 \rightarrow \tau^\pm\tilde{\tau}_1$ 
  - $\tilde{\chi}_1^0$  moderately long-lived  $\rightarrow$  decays in tracker
  - $\tilde{\tau}_1$  charged long-lived  $\rightarrow$  interacts with detector
- Other decay chains studied too:
  - $\tilde{g} \rightarrow jj\tilde{\chi}_1^0$ ,  $\tilde{\chi}_1^0 \rightarrow \pi^\pm\tilde{\tau}_1$  &  $\tilde{g} \rightarrow jj\tilde{\chi}_1^\pm$ ,  $\tilde{\chi}_1^\pm \rightarrow \nu_\tau\tilde{\tau}_1$

Acharya et al, EPJC 80 (2020) 572

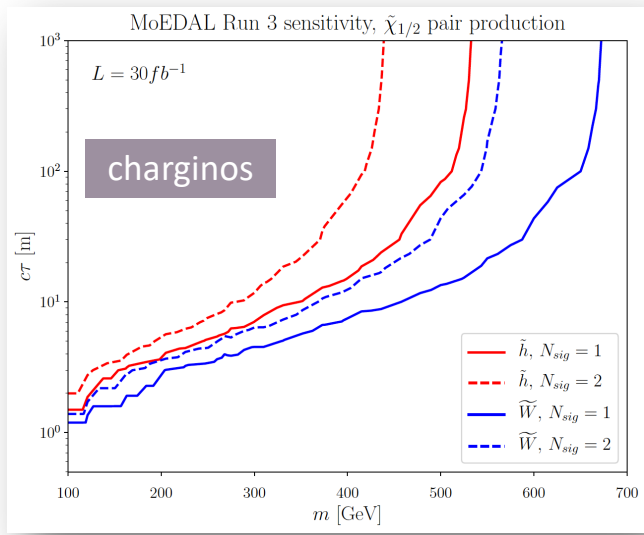

MoEDAL can cover long-lifetime region in Run 3 for gluinos, stops, sleptons and charginos

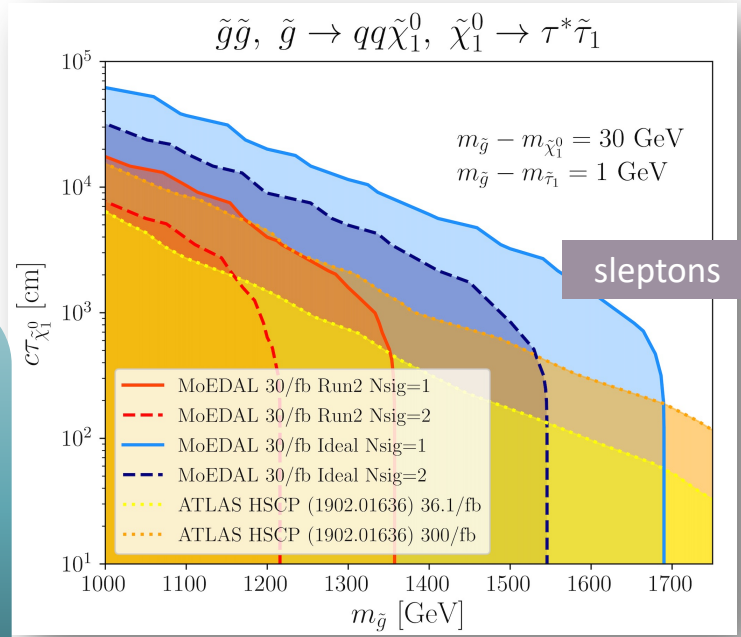

Felea, VAM et al, EPJC 80 (2020)

431

Study comparing MoEDAL vs. CMS:  
Sakurai, VAM et al, J.Phys.Conf.Series 1586 (2020) 012018

# Multiply charged particles – model-specific

- Doubly charged particles
  - Predicted in left-right symmetric models, seesaw neutrino models, little Higgs models, ... (+ SUSY extensions), extra dimensions, ...
  - models considered: (scalar, fermion)  $\times$  ( $SU(2)$ : singlet, triplet)
- 2-, 3-, 4-ply charged states occur in some radiative neutrino mass models
  - long-lived due to small neutrino mass and high electric charge

MoEDAL can cover long-lifetime region in Run 3 and HL-LHC

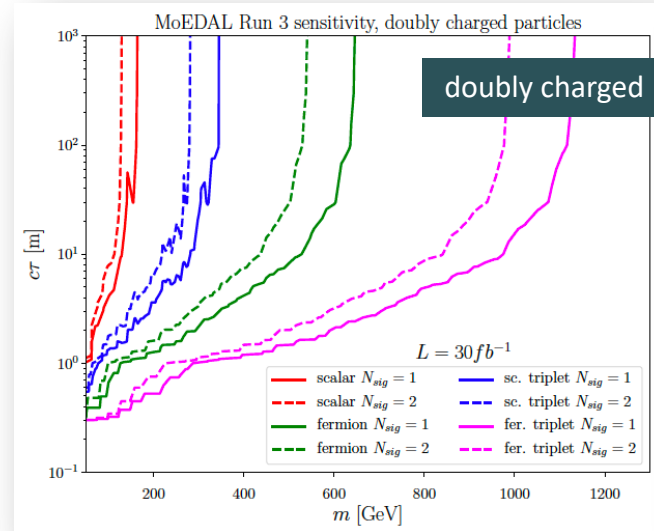

Acharya *et al*, [EPJC 80 \(2020\) 572](#)

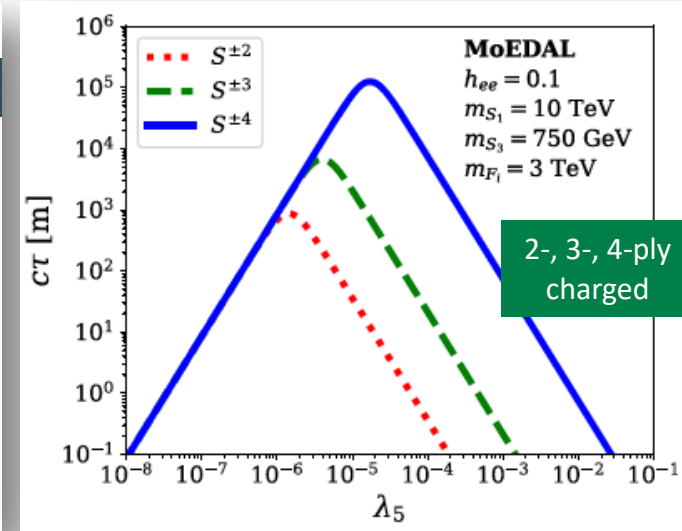

Hirsch *et al*, [EPJC 81 \(2021\) 697](#)



# Multiply charged particles – generic case

- Phenomenological study independent of underlying model
- Includes all production processes, including those with photons
  - most experimental searches only assume Drell-Yan
  - for high charges, photon contributions become very relevant

SU(2) singlet	color singlet	color triplet
spin 0	colorless scalar	colored scalar
spin 1/2	colorless fermion	colored fermion

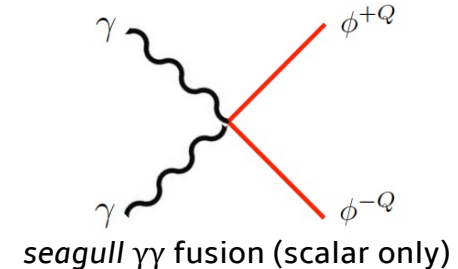
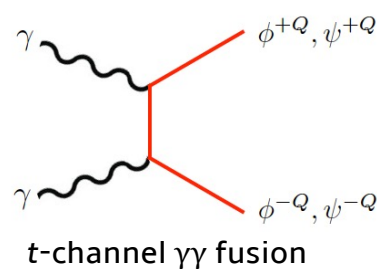
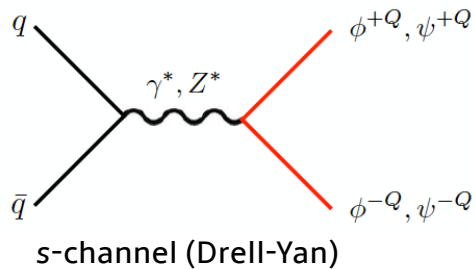

- Production of a bound state is considered
  - constrained by ATLAS and CMS searches for diphoton events
    - not relevant for MoEDAL

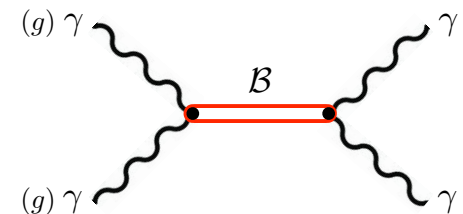

# MoEDAL reach

- Singly charged colorless scalars only observable at HL-LHC
- MoEDAL sensitivity to colored scalars similar to colored fermions
- For high charges up to  $8e$  good sensitivity expected from MoEDAL even in Run 3

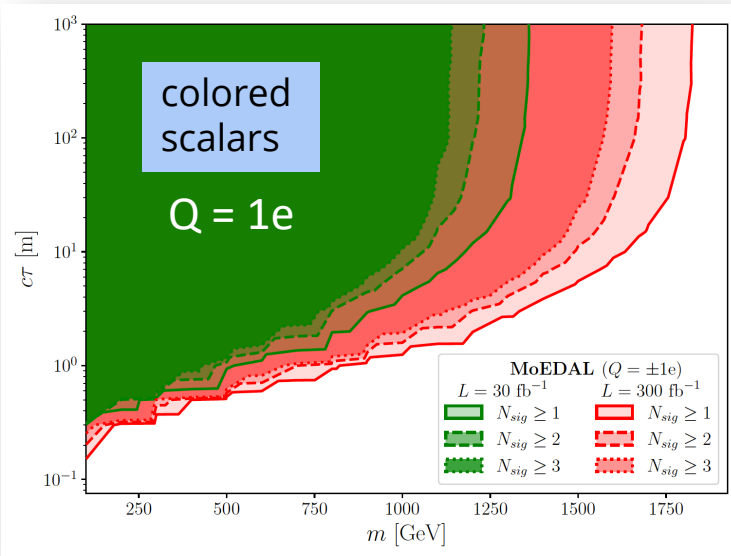

**Run 3**  
Masses up to  
2 TeV can be  
probed

**HL-LHC**  
Masses up to  
2.5 TeV can be  
probed

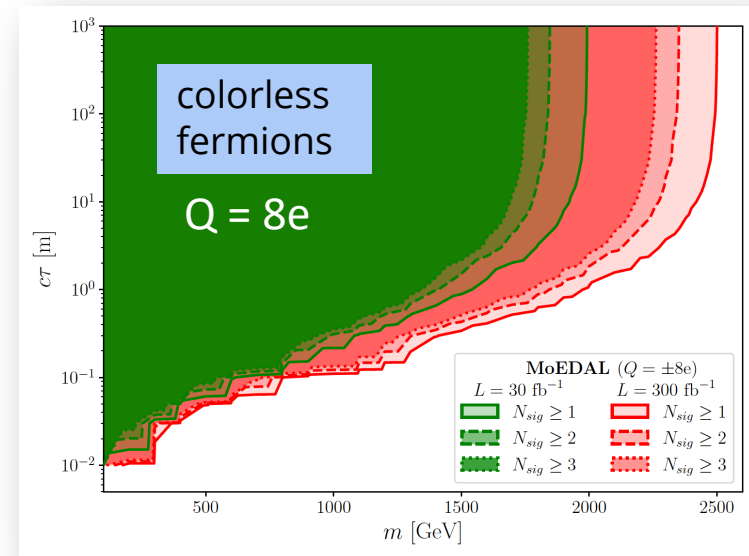

# MoEDAL vs. ATLAS/CMS

- Grey region excluded by ATLAS/CMS Run 1 / Run 2 searches
- ATLAS/CMS direct detection based on searches for **large  $dE/dx$**   $\rightarrow$  better sensitivity at **low charges**
- ATLAS/CMS searches for **diphoton resonances** offer better coverage at **high charges**
- **MoEDAL has the best sensitivity at intermediate electric charges at HL-LHC**

Altakach, Lamba, Masełek, VAM,  
Sakurai, [EPJC 82 \(2022\) 848](#)

Run 3

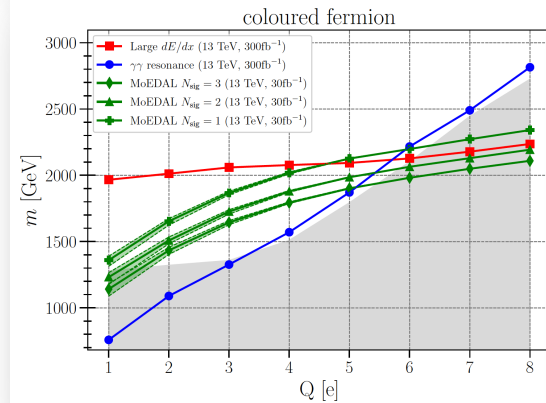
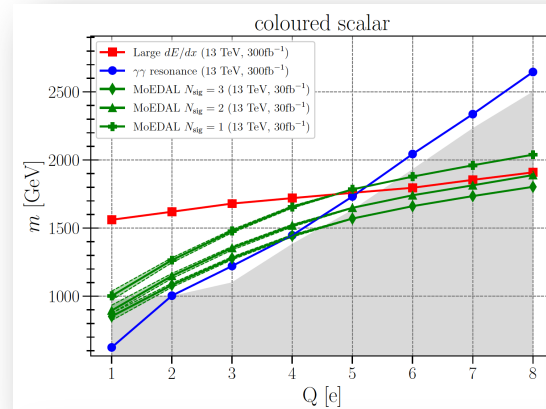

HL-LHC

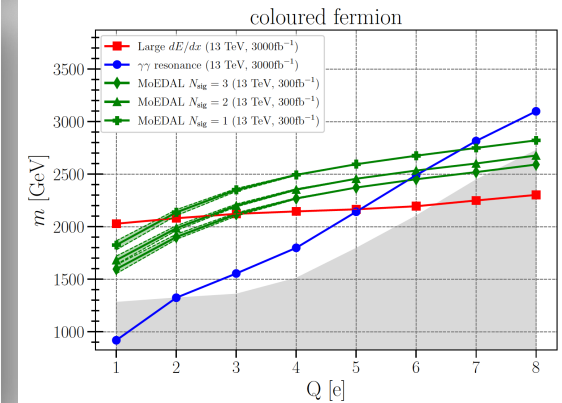
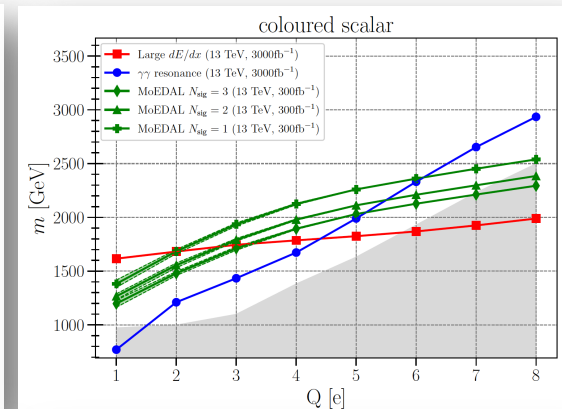

# Beyond LHC: MEDICI @ FCC-hh

- MoEDAL preliminary plans for **MEDICI** (Monopole and Exotics Detector Infrastructure for Colliding Ions)
- MEDICI HIP  $\rightarrow$  a polyhedral “ball” with radius 1 m sensitive to magnetic and electric charges
- Assuming  $3 \text{ ab}^{-1}$  and no intervening material, magnetic monopole masses up to  **$\sim 25 \text{ TeV}$**  can be reached

MoEDAL contribution to Snowmass, [arXiv:2209.03988](https://arxiv.org/abs/2209.03988), EPJ-ST, to appear

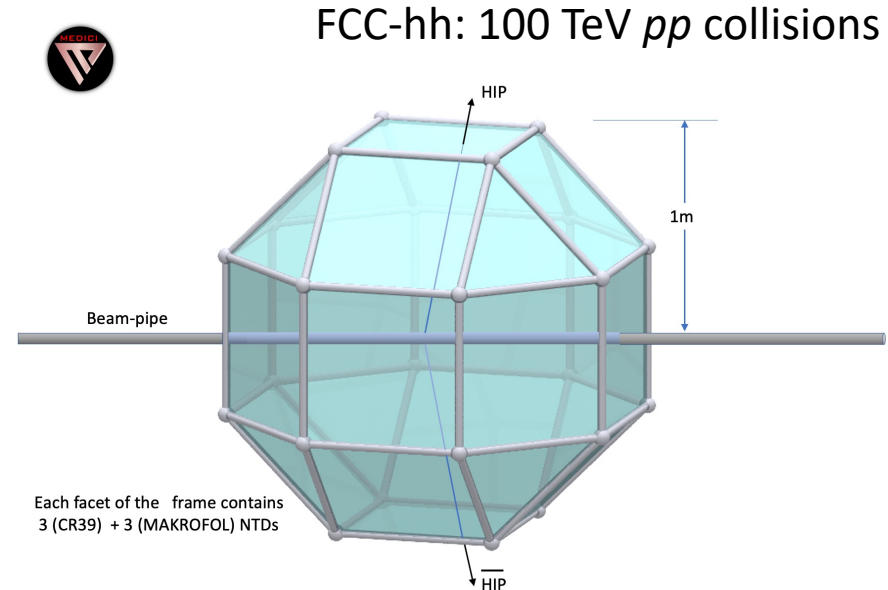

	Magnetic charge ( $g_D$ )					
	1	2	3	4	5	6
Spin	95% CL mass limits [ $\text{TeV}/c^2$ ]					
0	14.9	17.0	18.2	19.1	19.8	20.3
$1/2$	20.0	22.4	23.7	24.7	25.5	26.1
1	20.5	22.7	23.9	24.8	25.5	26.1

# Summary & outlook

- Highly ionizing particles are predicted in various scenarios of New Physics
  - Single or multiple electric charges
  - Isolated magnetic charges
- Growing interest in searching for these states in collider experiments
  - Combining  $dE/dx$  and timing information
- ATLAS & MoEDAL work in complementary way towards this direction
- Several studies show promising prospects for experiments to explore charges  $\leq 10e$  in future LHC runs
- Stay tuned for upcoming MoEDAL results!
  - Run-2 NTD analysis @ 13 TeV → improved sensitivity to electric charges
  - Magnetic monopoles in Schwinger mechanism probed in CMS Run-1 beam pipe

Thank you for your  
attention!

# Spares

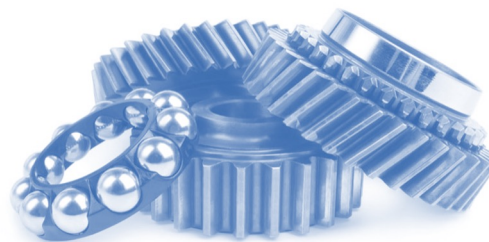

# LHC & High Luminosity LHC (HL-LHC)

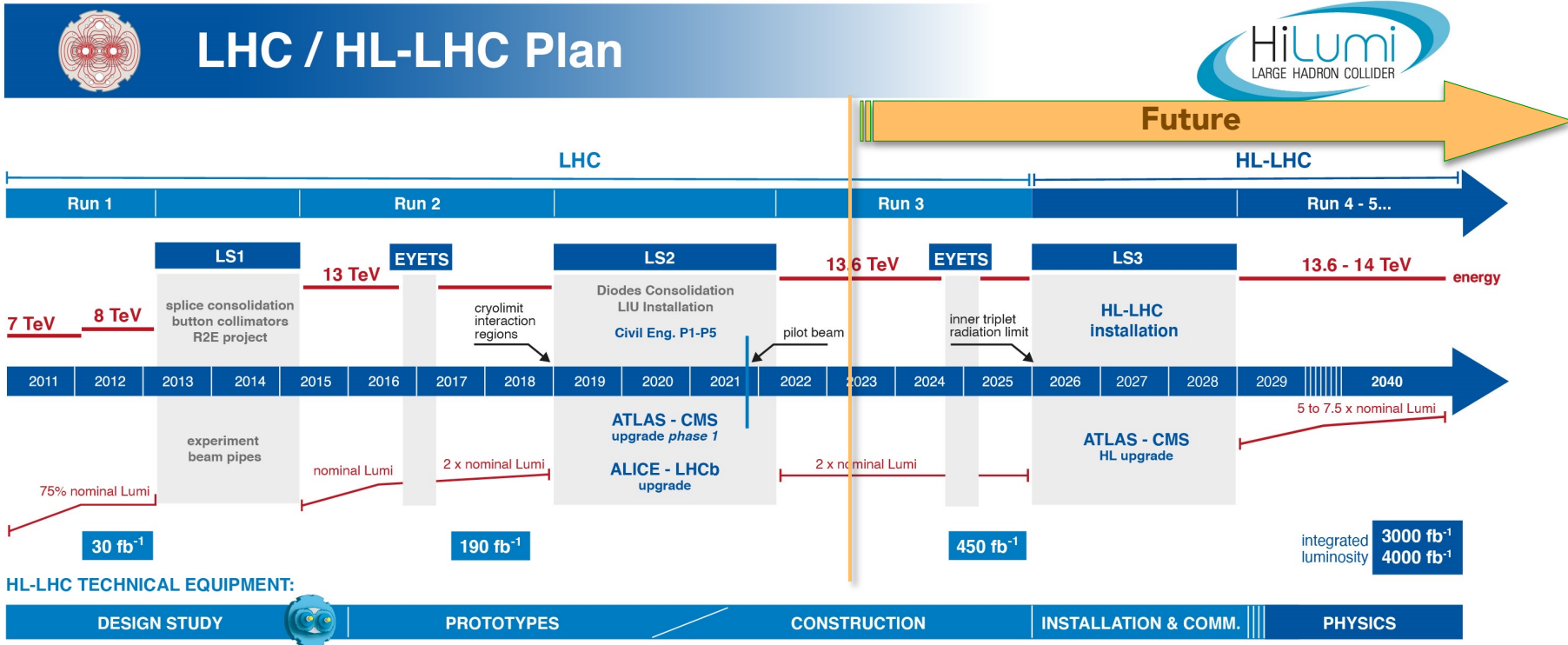

**HL-LHC CIVIL ENGINEERING:**

DEFINITION	EXCAVATION	BUILDINGS
------------	------------	-----------



# Heavy charged LL particles in ID+calo+MDT

- 36 fb<sup>-1</sup> of 13 TeV  $pp$  collisions
- Detectors
  - Pixel →  $dE/dx$
  - Tile, MDT, RPC → ToF
- Combination of  $dE/dx$  and ToF for R-hadrons
- Stau SR based only on ToF

[Phys. Rev. D 99 \(2019\) 092007](#)

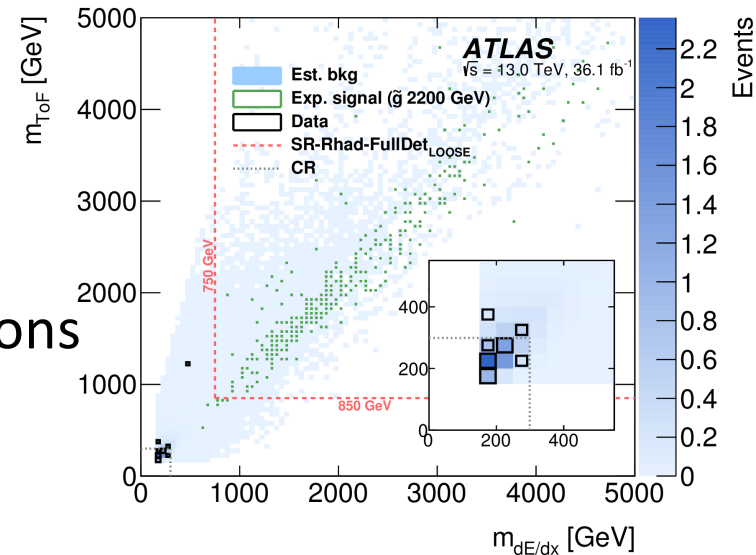

Signal region	Trigger	Candidate selection	Candidates per event	Final requirements				
				$ \eta $	$p$ [GeV]	$\beta_{\text{ToF}}$	$(\beta\gamma)_{dE/dx}$	Mass
SR-Rhad-MSagno	$E_T^{\text{miss}}$	ID+CALO	$\geq 1$	$\leq 1.65$	$\geq 200$	$\leq 0.75$	$\leq 1.0$	ToF & $dE/dx$
SR-Rhad-FullDet	$E_T^{\text{miss}}/\mu$	LOOSE	$\geq 1$	$\leq 1.65$	$\geq 200$	$\leq 0.75$	$\leq 1.3$	ToF & $dE/dx$
SR-Rhad-FullDet	$E_T^{\text{miss}}/\mu$	ID+CALO	$\geq 1$	$\leq 1.65$	$\geq 200$	$\leq 0.75$	$\leq 1.0$	ToF & $dE/dx$
SR-2Cand-FullDet	$E_T^{\text{miss}}/\mu$	LOOSE	$= 2$	$\leq 2.00$	$\geq 100$	$\leq 0.95$	-	ToF
SR-1Cand-FullDet	$E_T^{\text{miss}}/\mu$	TIGHT	$= 1$	$\leq 1.65$	$\geq 200$	$\leq 0.80$	-	ToF

# MoEDAL physics goals

- MoEDAL baseline detector optimised for the detection of (meta)stable **highly ionising particles**
  - high charges (**high  $z$** )
    - magnetic  $\rightarrow$  **monopoles!**
    - electric  $\rightarrow$  Highly Electrically Charged particles (**HECOs**)
  - slow moving (**low  $\beta$** )  $\Rightarrow$  massive

- MAPP upgrade designed for neutral LLPs and millicharged particles**

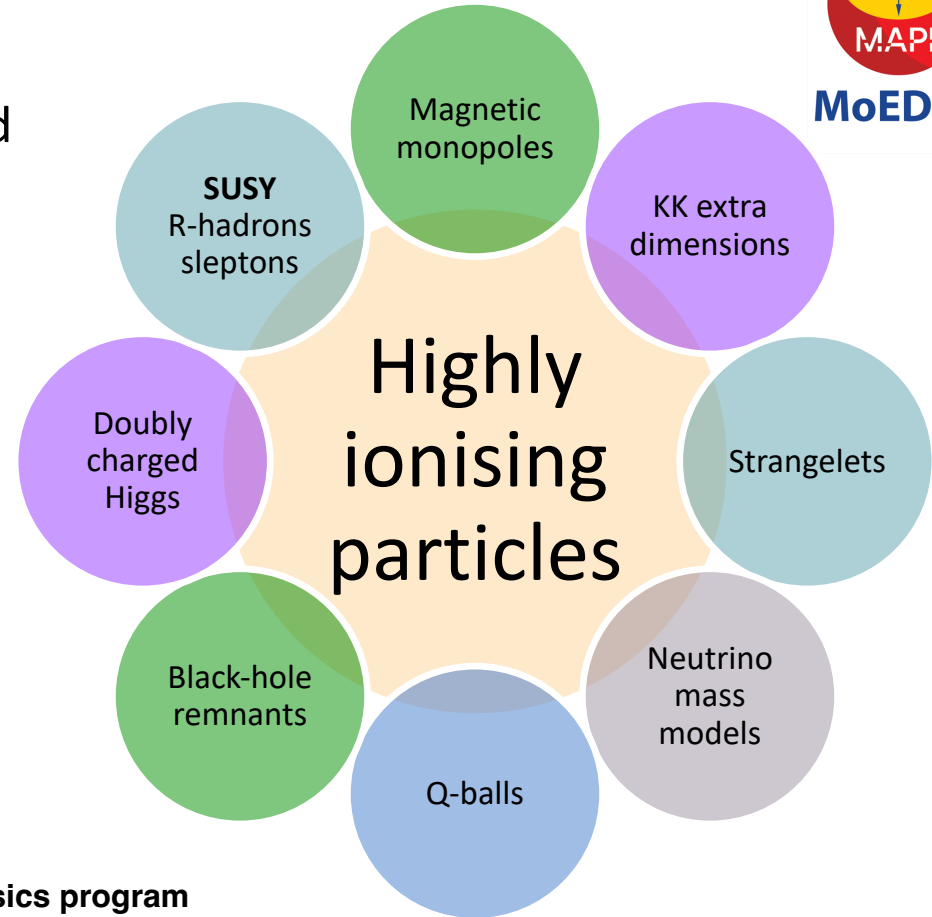

MoEDAL

MoEDAL physics program

[Int. J. Mod. Phys. A29 \(2014\) 1430050](#)



# Results

- 2016 – **First monopole results @ 8 TeV**  $\leftarrow$  [CERN Press Release](#)  
[JHEP 1608 \(2016\) 067](#) [[arXiv:1604.06645](#)]
- 2017 – **First monopole results @ 13 TeV** [Phys.Rev.Lett. 118 \(2017\) 061801](#) [[arXiv:1611.06817](#)]
- 2018 – **MMT results** [Phys.Lett.B 782 \(2018\) 510–516](#) [[arXiv:1712.09849](#)]
  - **spin-1 monopoles**  $\leftarrow$  **FIRST in colliders**
  - $\beta$ -dependent coupling
- 2019 – **MMT results** [Phys.Rev.Lett. 123 \(2019\) 021802](#) [[arXiv:1903.08491](#)]
  - **photon fusion** interpretation  $\leftarrow$  **FIRST at LHC**
- 2020 – **MMT search for Dyons**  $\leftarrow$  **FIRST in colliders**  
[Phys.Rev.Lett. 126 \(2021\) 071801](#) [[arXiv:2002.00861](#)]
- 2021 – **Schwinger thermal production**  $\leftarrow$  **FIRST**  
[Nature 602 \(2022\) 7895, 63](#) [[arXiv:2106.11933](#)]
- 2021 – **NTD & MMT**  $\leftarrow$  **FIRST NTD analysis** [arXiv:2112.05806](#)
  - **First limits in highly electrically charged objects**

# Run-2 MoEDAL deployment

## MMT

- Installed in forward region under beam pipe & in **sides**
- Approximately **800 kg** of Al
- Total 2400 aluminum bars

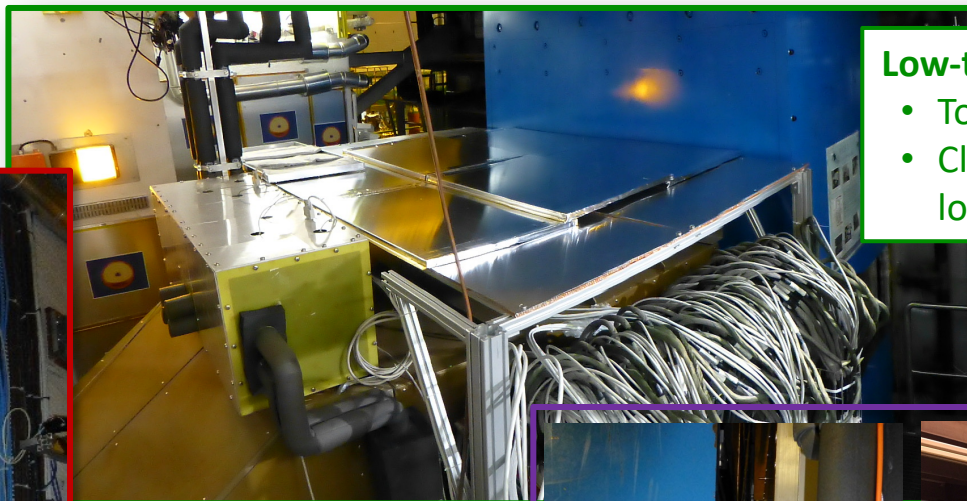

## Low-threshold NTD

- Top of VELO cover
- Closest possible location to IP



## HCC-NTD

Installed in LHCb acceptance between RICH1 and Trigger Tracker



# Monopoles via thermal Schwinger mechanism

Monopole-antimonopole pairs may be produced in strong magnetic fields present in heavy-ion collisions

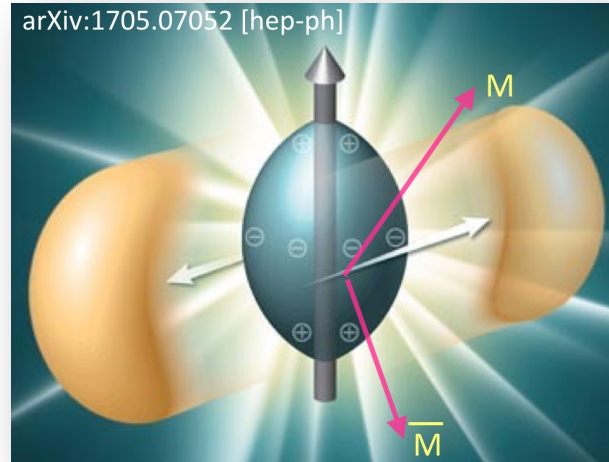

5.02 TeV/nucleon  
Pb-Pb Collisions

( $L_{\text{int}} = 0.235 \text{ nb}^{-1}$ )

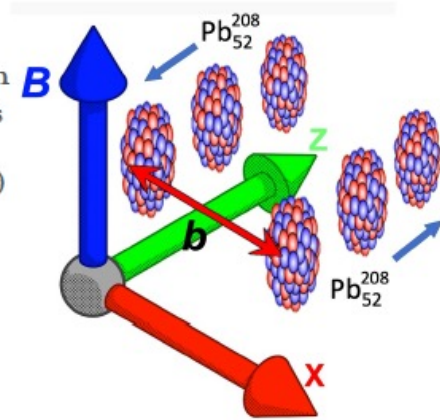

## Advantages over DY & $\gamma\gamma$ -fusion production

- cross-section calculation using semiclassical techniques  $\Rightarrow$  does not suffer from non-perturbative nature of coupling
- no exponential suppression  $e^{-4/\alpha}$  for finite-sized monopoles

Gould, Ho, Rajantie, [PRD 100, 015041 \(2019\)](#), [arXiv:2103.14454](#)  
Ho & Rajantie, [PRD 101, 055003 \(2020\)](#), [PRD 103 \(2021\) 11, 115033](#)

# Schwinger production results

- Exposure of MMTs in  $0.235 \text{ nb}^{-1}$  of **Pb-Pb heavy-ion collisions** at 5.02 TeV per nucleon
- Limits on monopoles of  $1 - 3 g_D$  and masses up to **75 GeV**
- First limits from collider experiment based on **non-perturbative calculation** of monopole production cross section
- First direct search sensitive to monopoles that are **not point-like**

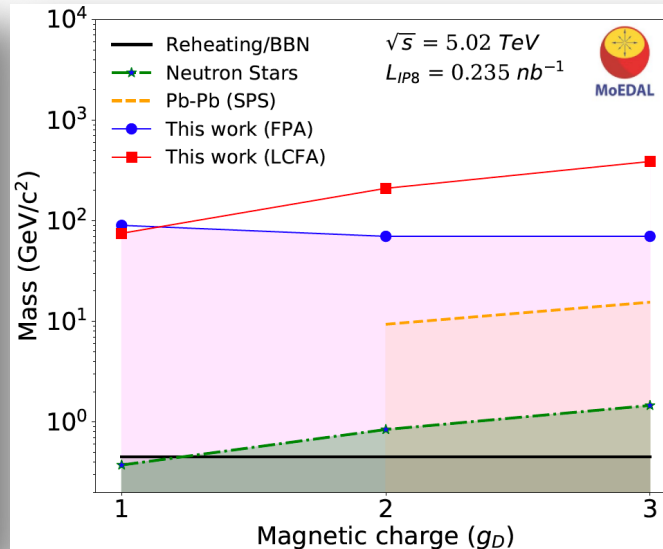
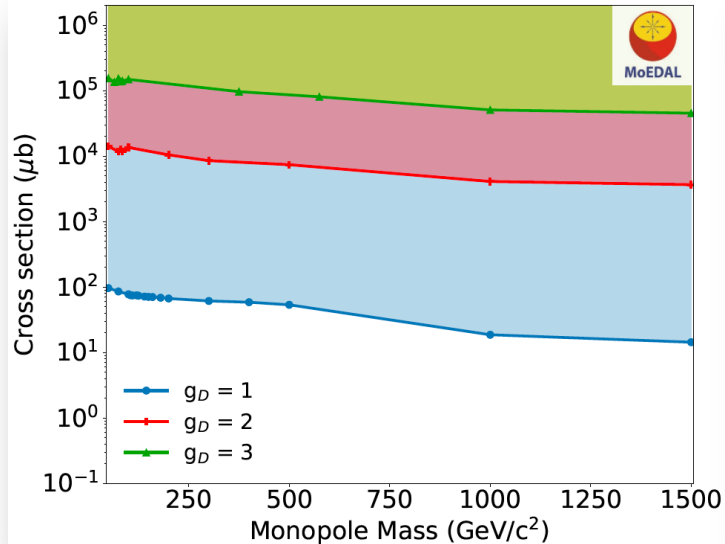

Monopole mass reach appears to be 20–30 times lower than current bounds from ATLAS and MoEDAL, however, this cross-section calculation is theoretically sound

# Monopoles in Schwinger mechanism – Future



- Run-1 CMS beam pipe analysis in heavy-ion run
- HL-LHC projection for MoEDAL's MMTs
  - Conservative theoretical assumptions
  - Nuclear track detectors not included in projection
  - Assuming  $2.5 \text{ nb}^{-1}$  Pb-Pb collisions at  $v_{NN} = 5.52 \text{ TeV}$

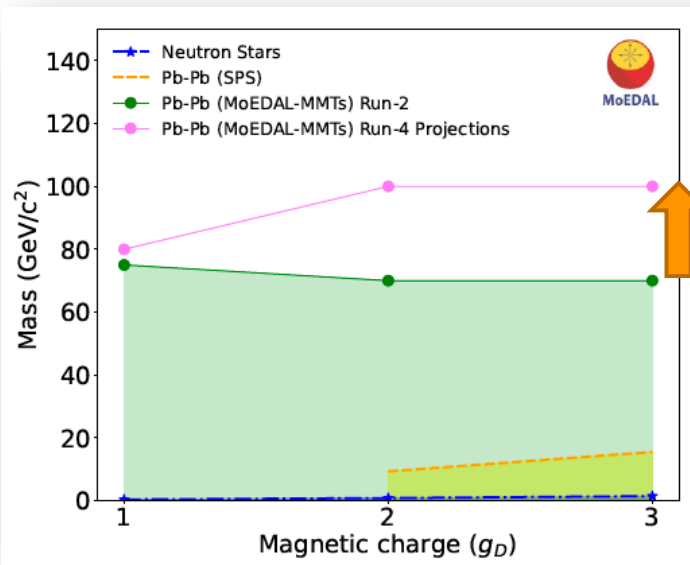

**~20 GeV increase in sensitivity in HL-LHC heavy-ion run**

Opportunities for new physics searches with heavy ions at colliders, Snowmass 2021 white paper, [arXiv:2203.05939](https://arxiv.org/abs/2203.05939)

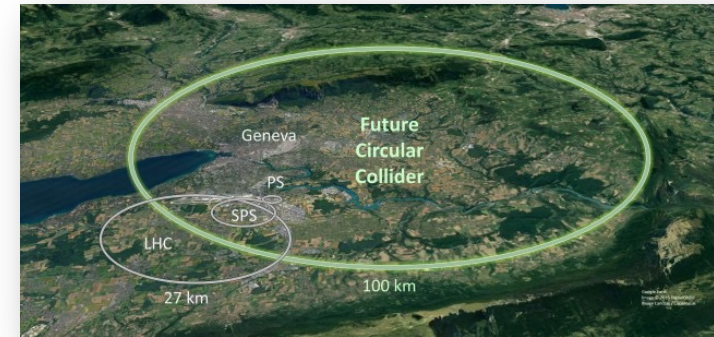

For FCC :  $\sqrt{s_{NN}} \sim 40 \text{ TeV}$   
 $\Rightarrow M \gtrsim 600 \text{ GeV}$

Theoretical improvements in semiclassical and fully classical approaches

# CMS beam pipe

## Beam pipe

- most directly exposed piece of material
- covers very high magnetic charges

- **2012:** first pieces of CMS beam pipe tested [[EPJC72 \(2012\) 2212](#)]
  - far from collision point
- **Feb 2019:** CMS officially transfers ownership of the Run-1 CMS beam pipe to MoEDAL

- Beam pipe scanned with SQUID at ETH Zurich
- Analysis for Pb-Pb collision data ongoing
- **Schwinger mechanism** assumed
- Results to be released soon

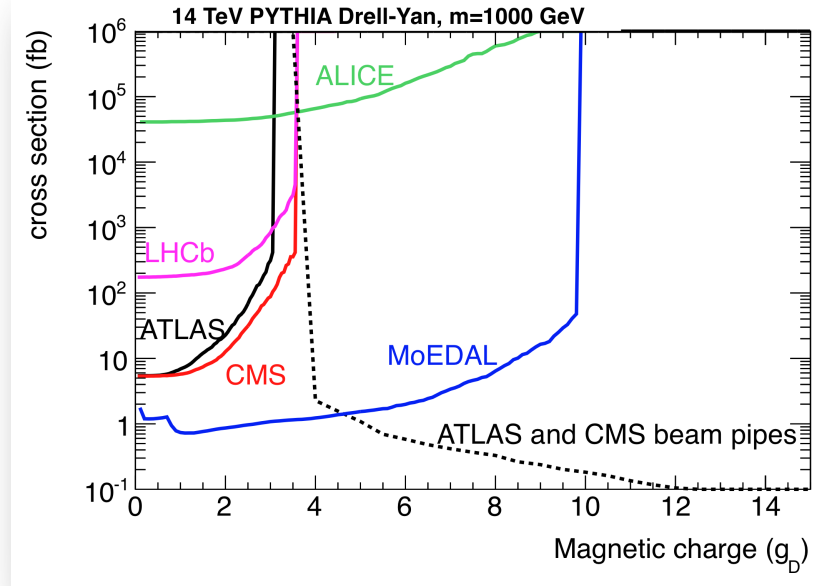

De Roeck et al, [EPJC72 \(2012\) 1985](#)



CERN Courier, Mar-Apr 2019





# NTD+MMT search for HECOs and monopoles

Prototype NTD array of  $125 \times 25 \text{ cm} \times 25 \text{ cm}$  stacks ( $7.8 \text{ m}^2$ )

- 3 layers of CR39<sup>®</sup> polymer  $\rightarrow$  low threshold  $z/\beta \sim 5 \Rightarrow$  time intensive analysis
- 3 layers of Makrofol DE<sup>®</sup>  $\rightarrow$  used in analysis (less “visual noise”); threshold  $z/\beta \sim 50$
- 3 layers of Lexan<sup>®</sup>  $\rightarrow$  protective layers only

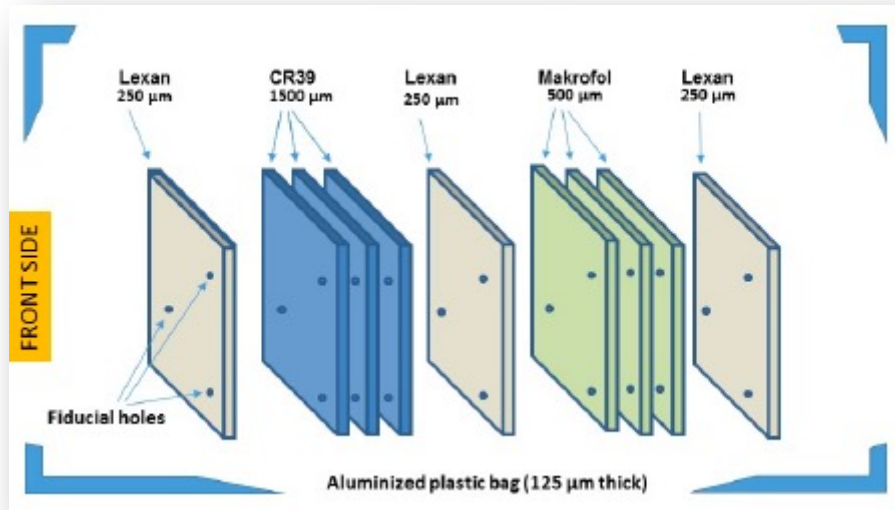

NTDs sheets kept in boxes mounted onto LHCb VELO alcove walls



# NTD results on HECOs

- Drell-Yan production
  - Z exchange is also taken into account for fermions [Song & Taylor, *J.Phys.G* 49 (2022) 045002]

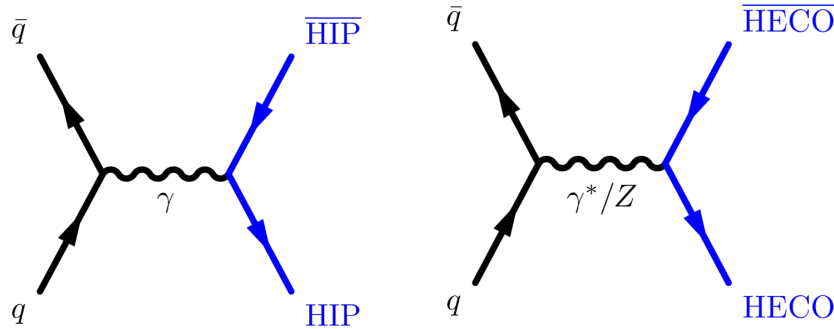

- non-perturbativity of large coupling can be tackled by appropriate **resummation** [Alexandre, Mavromatos, *in progress*]
- Limits set on HECO pairs with cross-sections from  $\sim 30 - 70 \text{ pb}$

MoEDAL, [arXiv:2112.05806](https://arxiv.org/abs/2112.05806) [hep-ex]

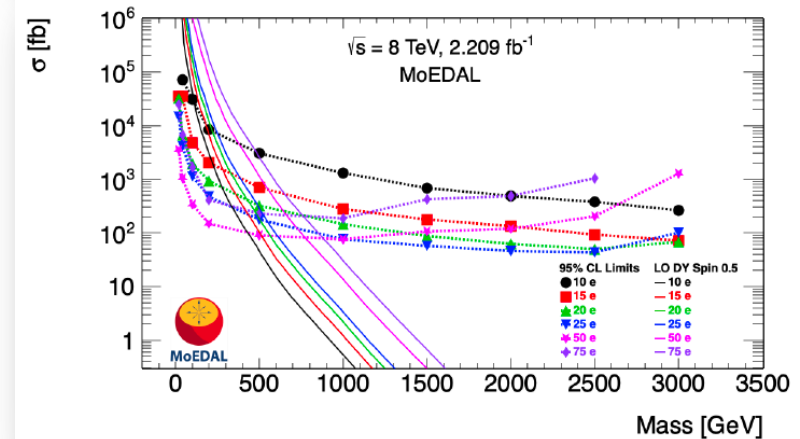
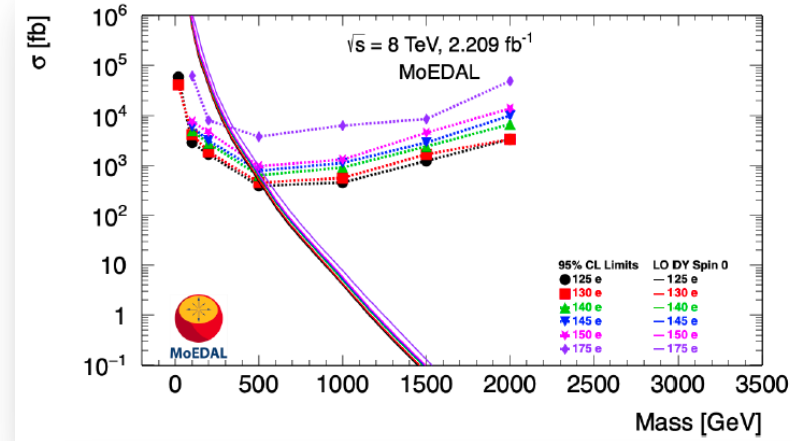

# HIP kinematics

- MoEDAL NTDs sensitive to highly ionising particles with velocities  $\beta < 0.15 |Q|$ 
  - if sufficiently slow moving, even low charges may be detected
- Assumed to be “detector-stable”, i.e. they decay after passing the whole detector volume
- MoEDAL is background-free experiment
  - discovery scenarios require **1, 2 or 3 signal events ( $N_{\text{sig}}$ )**
- Integrated luminosities at IP8 (LHCb/MoEDAL)
  - Run-3 →  $30 \text{ fb}^{-1}$
  - High Luminosity LHC (HL-LHC) →  $300 \text{ fb}^{-1}$
  - roughly 10 times less than ATLAS & CMS

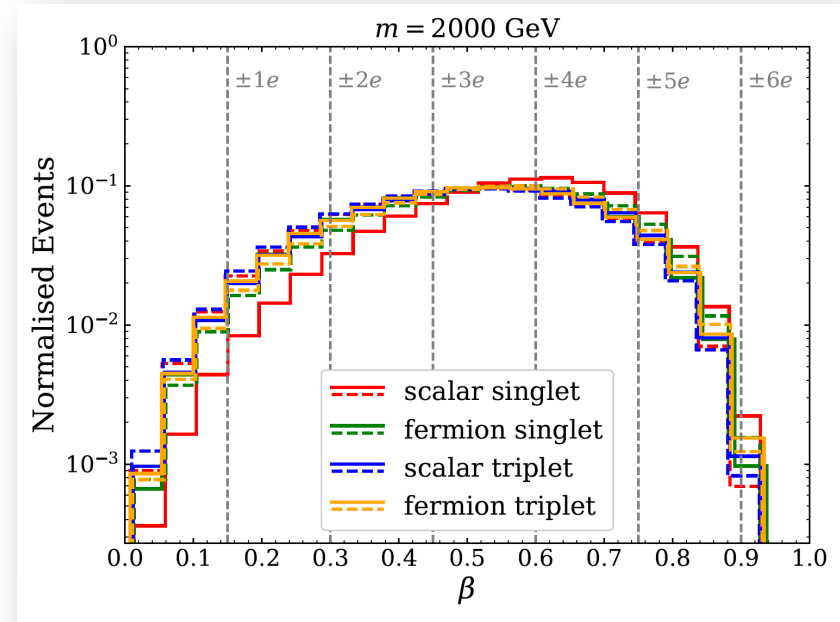

# Long-lived SUSY partners

- Supersymmetric charged long-lived states: **sleptons, R-hadrons, charginos**
  - plus **doubly charged higgsinos** in *L-R* symmetric models
- ATLAS & CMS have constrained these spartners. Analyses limited by:
  - trigger requirements
  - offline selections to suppress SM backgrounds
  - timing: signal from slow-moving particles to arrive within correct bunch crossings
- Due to absence of **trigger, timing and SM backgrounds**, MoEDAL can *relax* selection requirements and increase sensitivity to charged long-lived SUSY particles

