

Overview of recent ATLAS results

Markus Cristinziani, Universität Siegen

Workshop on the Standard Model and Beyond
Corfu, August 28 – September 8, 2022



Nice to be with you in person!

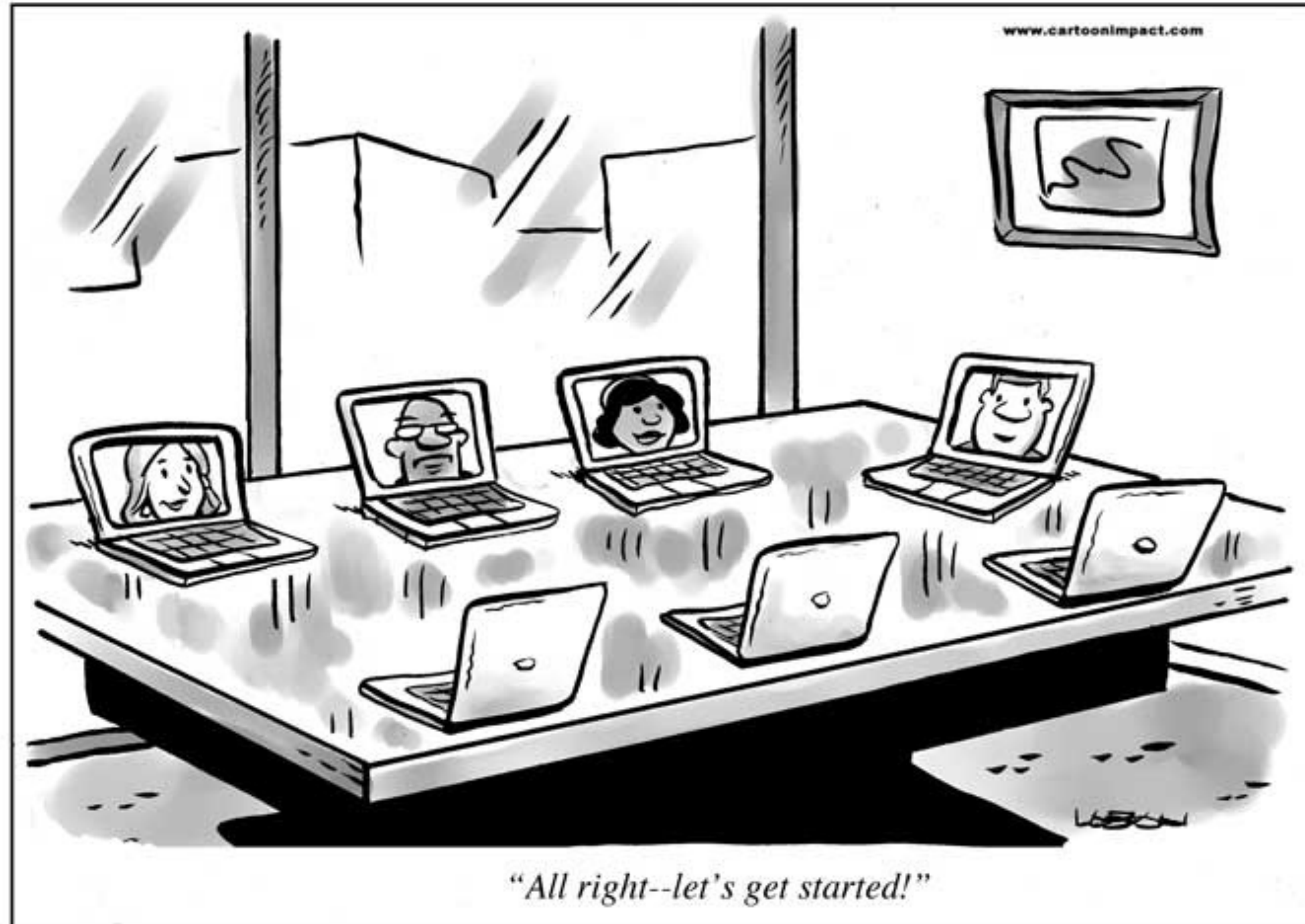

ATLAS experiment at the CERN LHC collider

Vast and rich physics program at the energy frontier

- understanding of electroweak symmetry breaking and of the BEH mechanism
- broad search program at the TeV scale addressing naturalness, dark matter, flavour
 - also sensitive to feeble interactions
- precise measurements of SM (EW, top, QCD) processes and heavy-flavour properties
 - indirect probes of BSM physics
- studies of the quark-gluon plasma properties

Fantastic dataset recorded in Run-2 (2015–2018)
after the Run-1 data set (2010–2012)

(incl. PbPb, XeXe and pPb collisions)

1078 papers submitted for publication so far

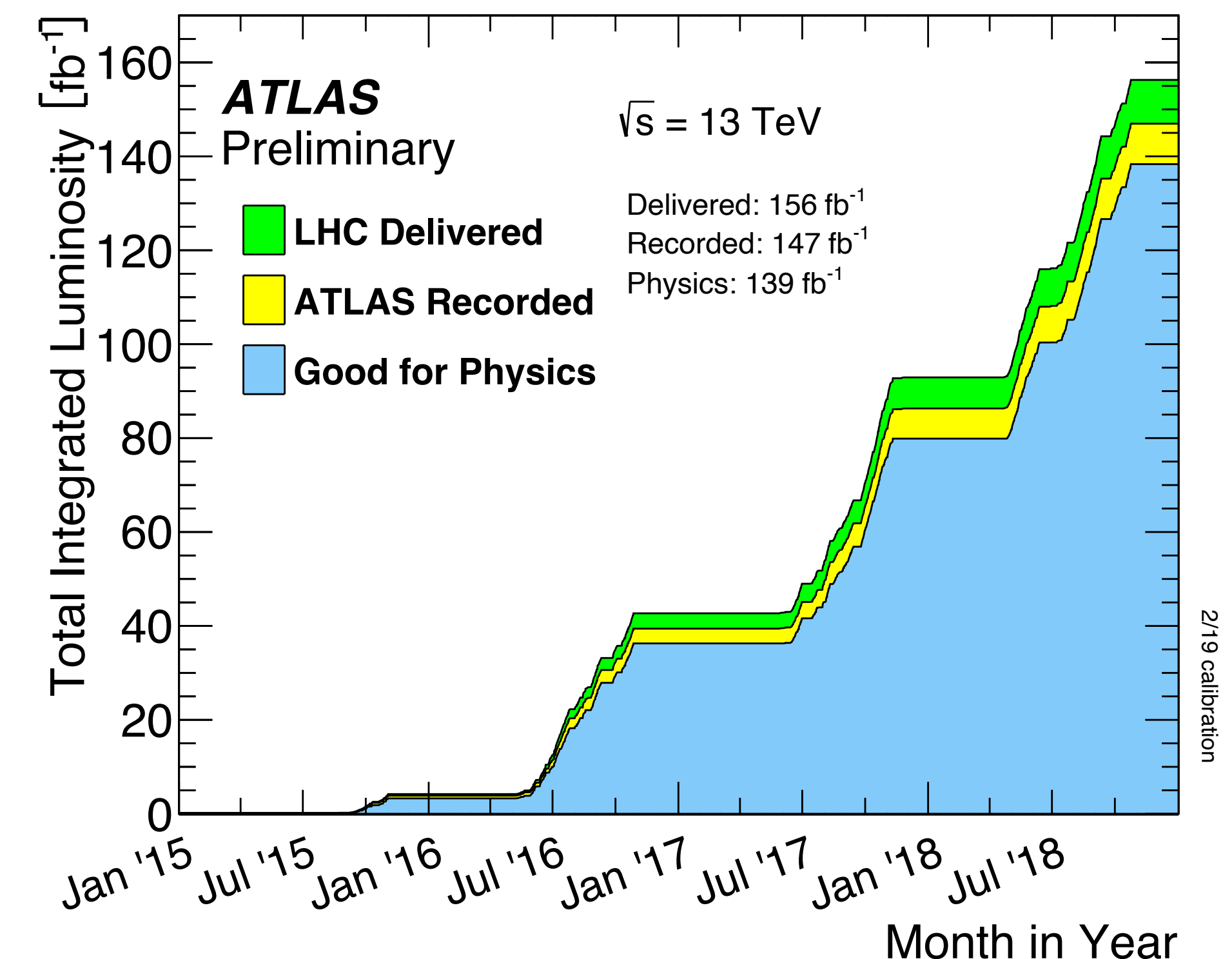

Very well understood detector performance

Full Run-2 dataset

- simulation of pileup condition, $\langle \mu \rangle \sim 35$ pp interactions per bunch crossing
- continuous improvements of identification and calibration of reconstructed objects

Electron trigger efficiency – keep threshold at $p_T = 26$ GeV

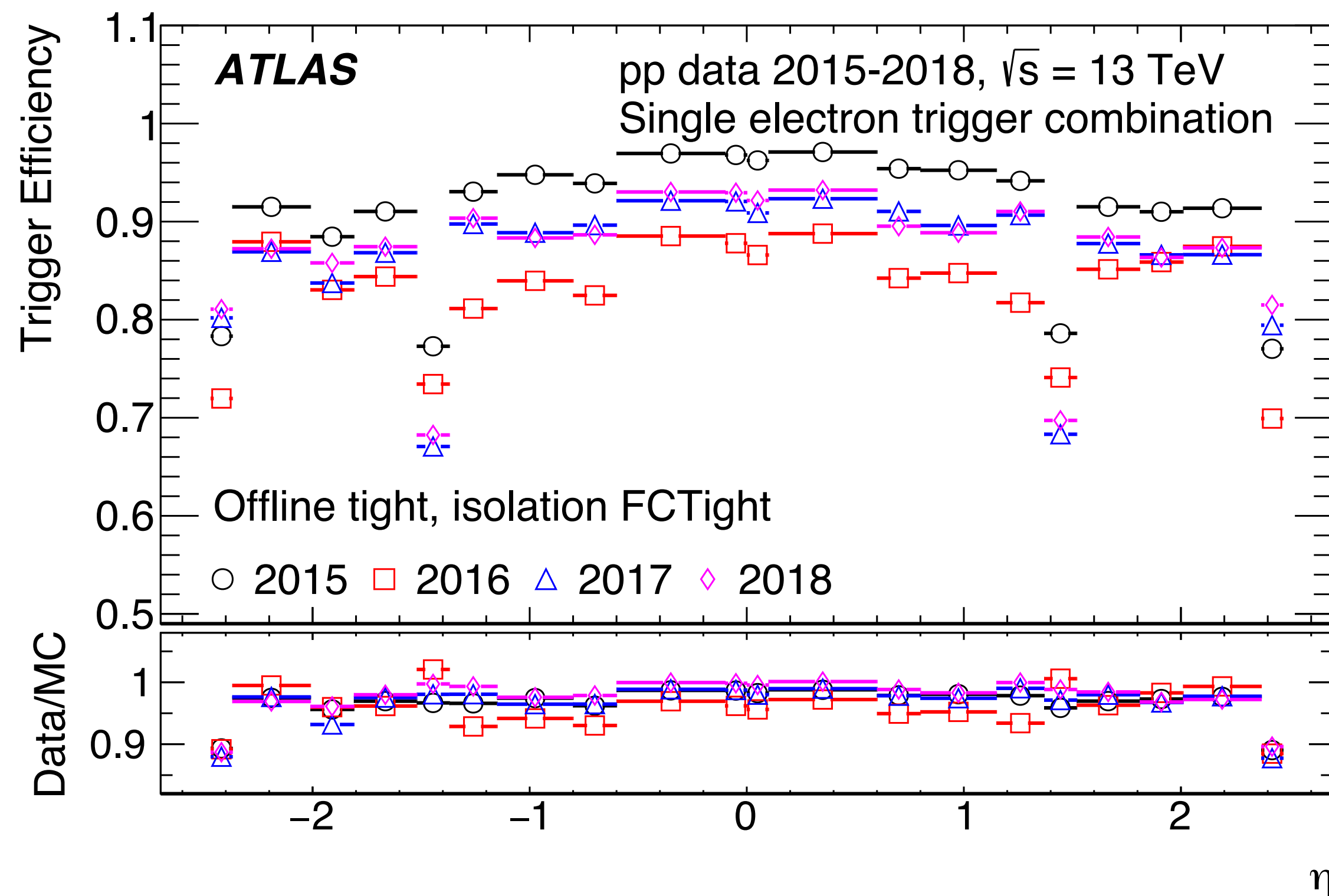

[Eur. Phys. J. C 80 \(2020\) 47](#)

Muon identification efficiency

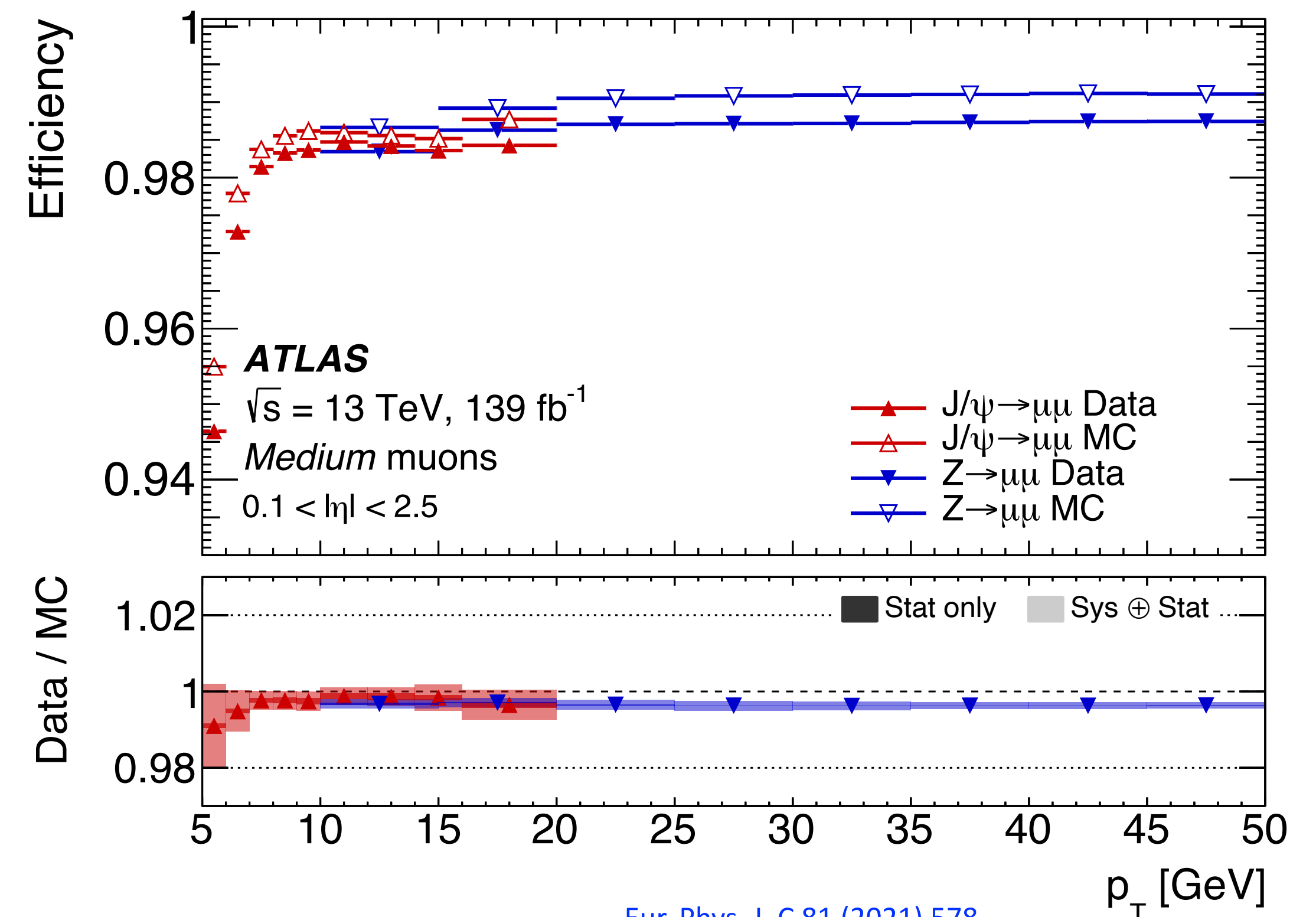

[Eur. Phys. J. C 81 \(2021\) 578](#)

Very well understood detector performance

Full Run-2 dataset

- simulation of pileup condition, ~ 35 pp interactions per bunch crossing
- continuous improvements of identification and calibration of reconstructed objects

Electron identification vs pileup

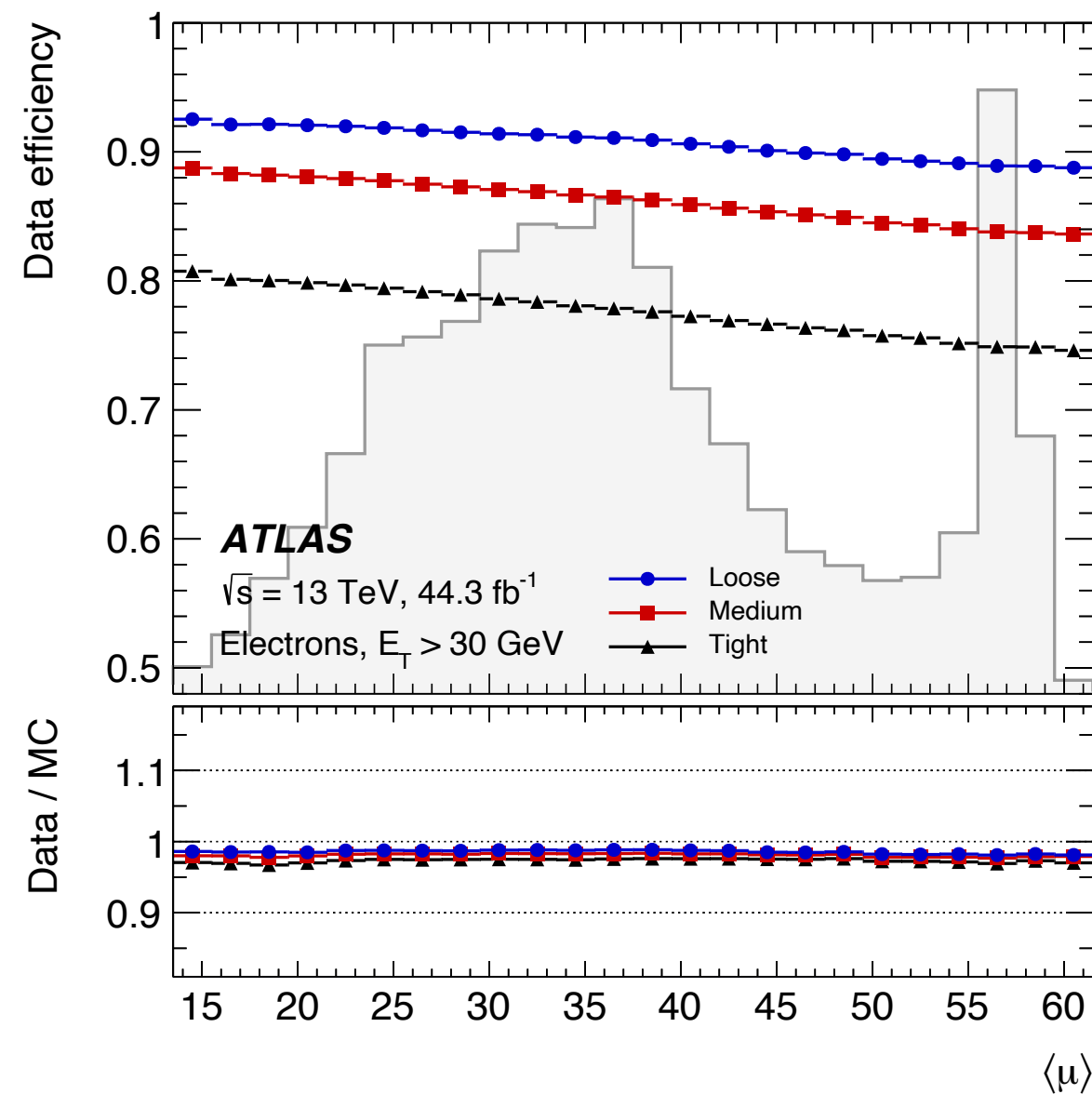

[JINST 14 \(2019\) P12006](#)

High- p_T hadron calibration check in-situ with $W \rightarrow \tau \rightarrow \pi$

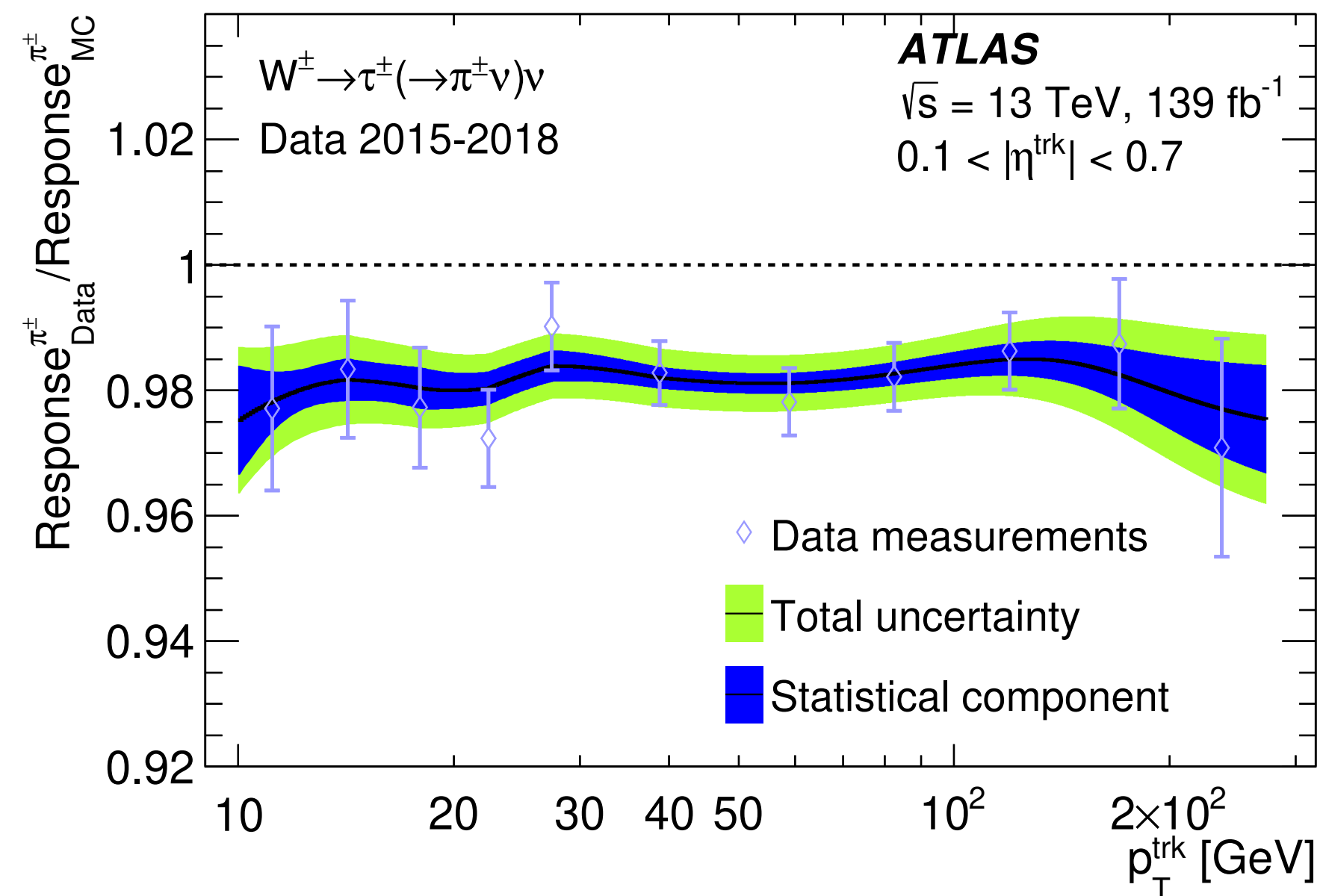

[Eur. Phys. J. C 82 \(2022\) 223](#)

b-tagging efficiency measured with $t\bar{t}$ events

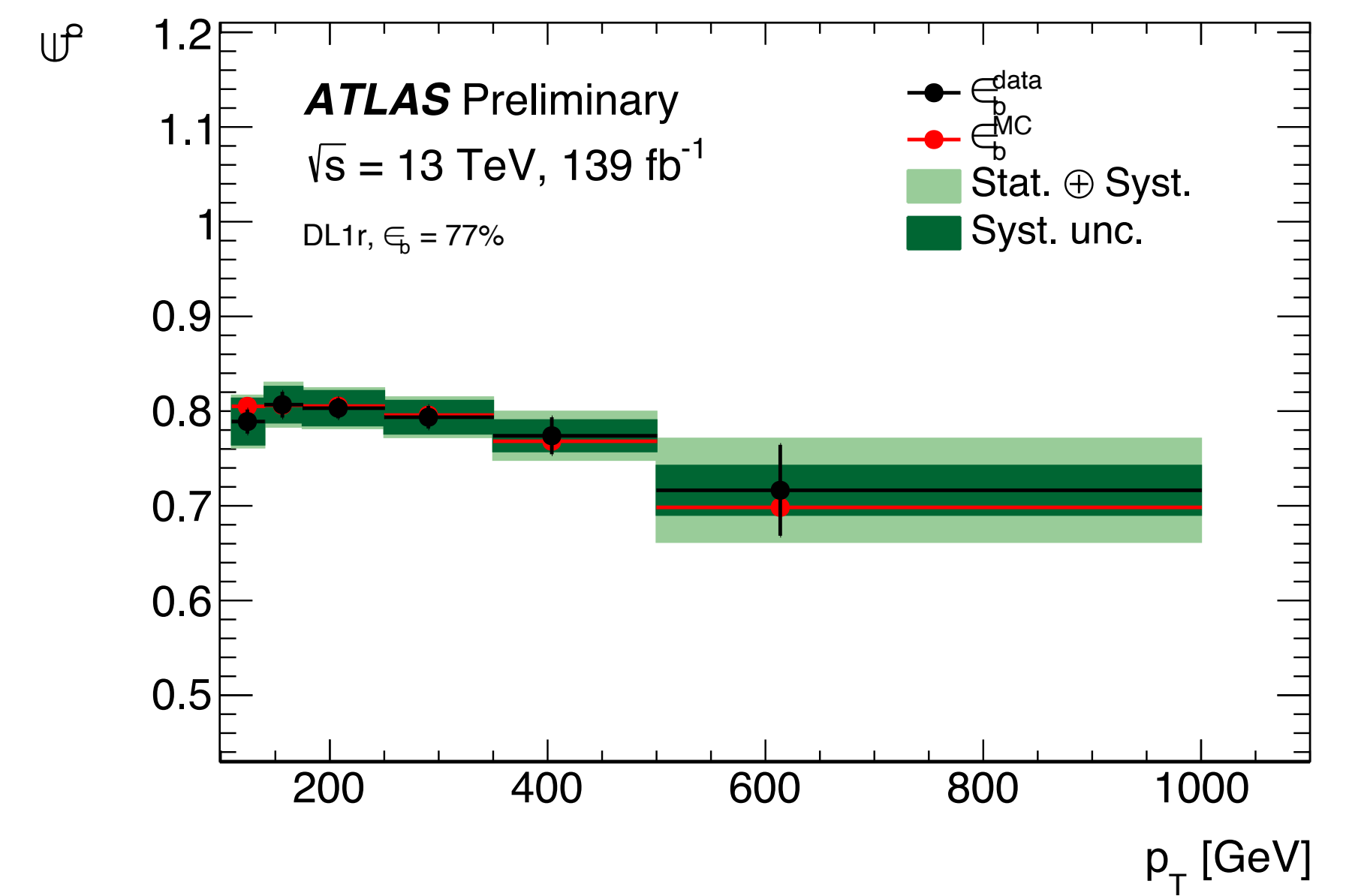

[ATLAS-CONF-2018-045](#)

Standard Model cross section measurements

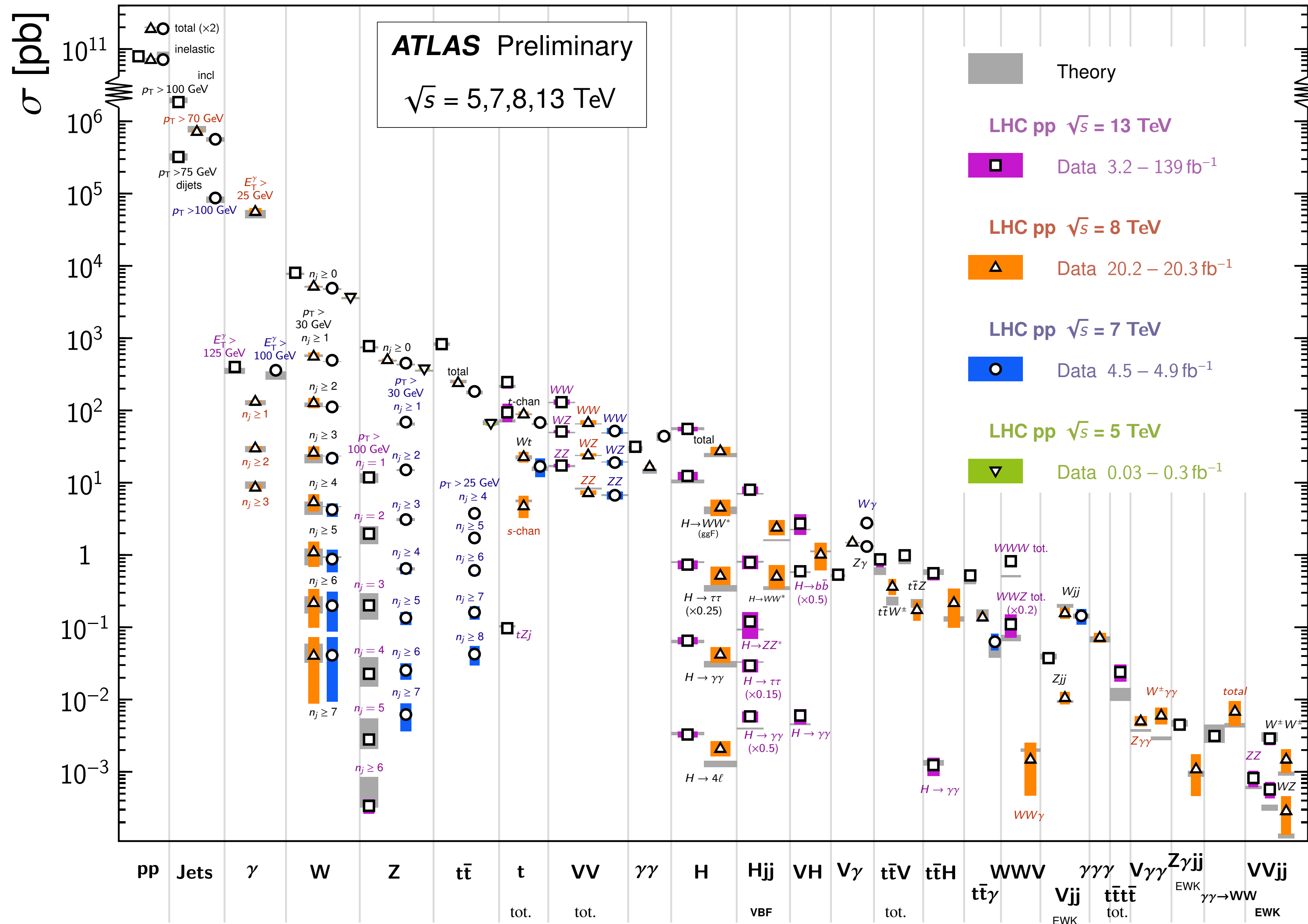

Large benefit from recent theory developments and computations

Elastic cross-section measurement

arXiv:2207.12246

Differential $d\sigma/dt$ $pp \rightarrow pp$ elastic cross section

- measure scattered protons with detectors located in roman pots 240m from IP
- special data taking with large β^* optics (2.5km)
- luminosity calibration from Van Der Meer scans

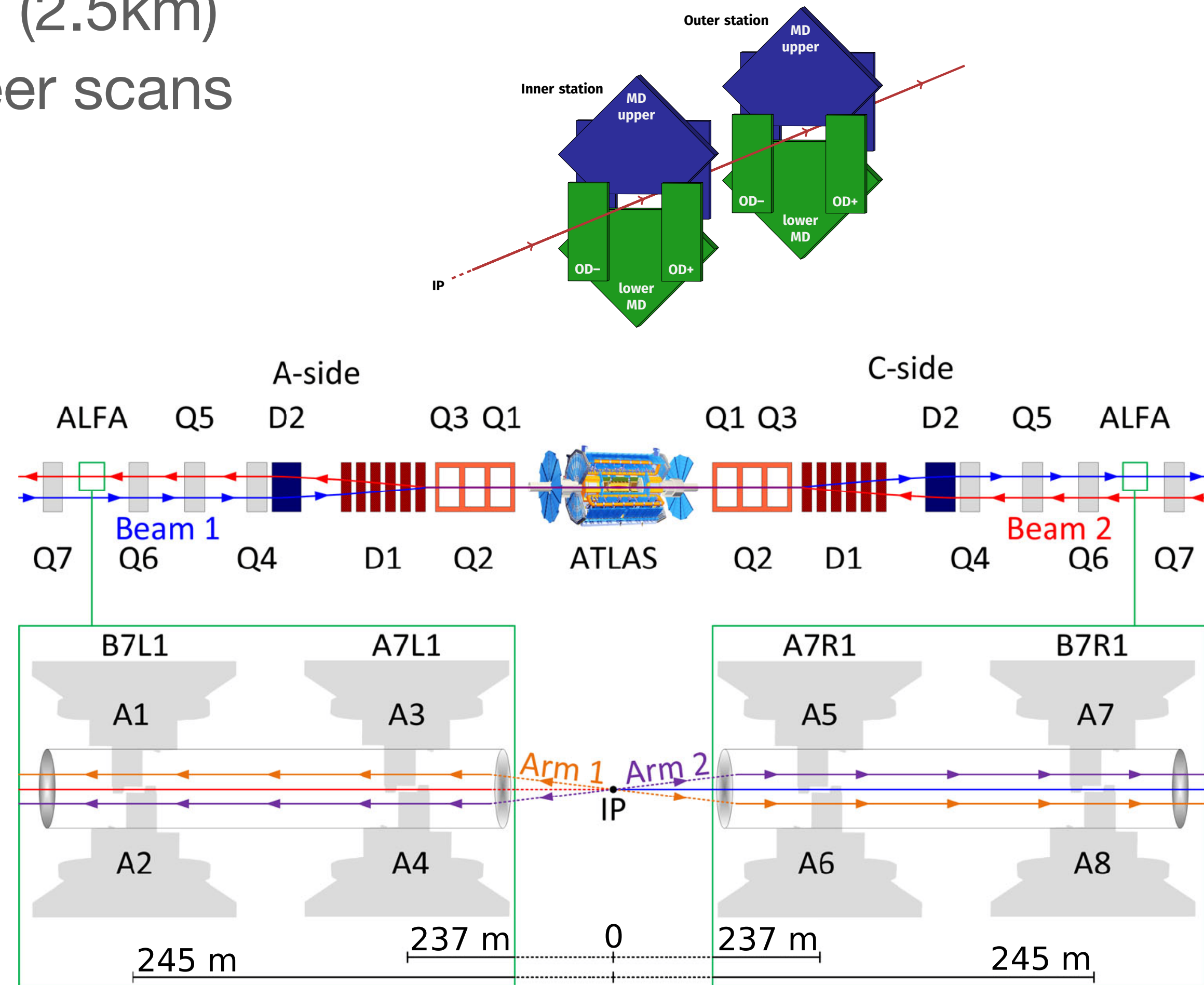
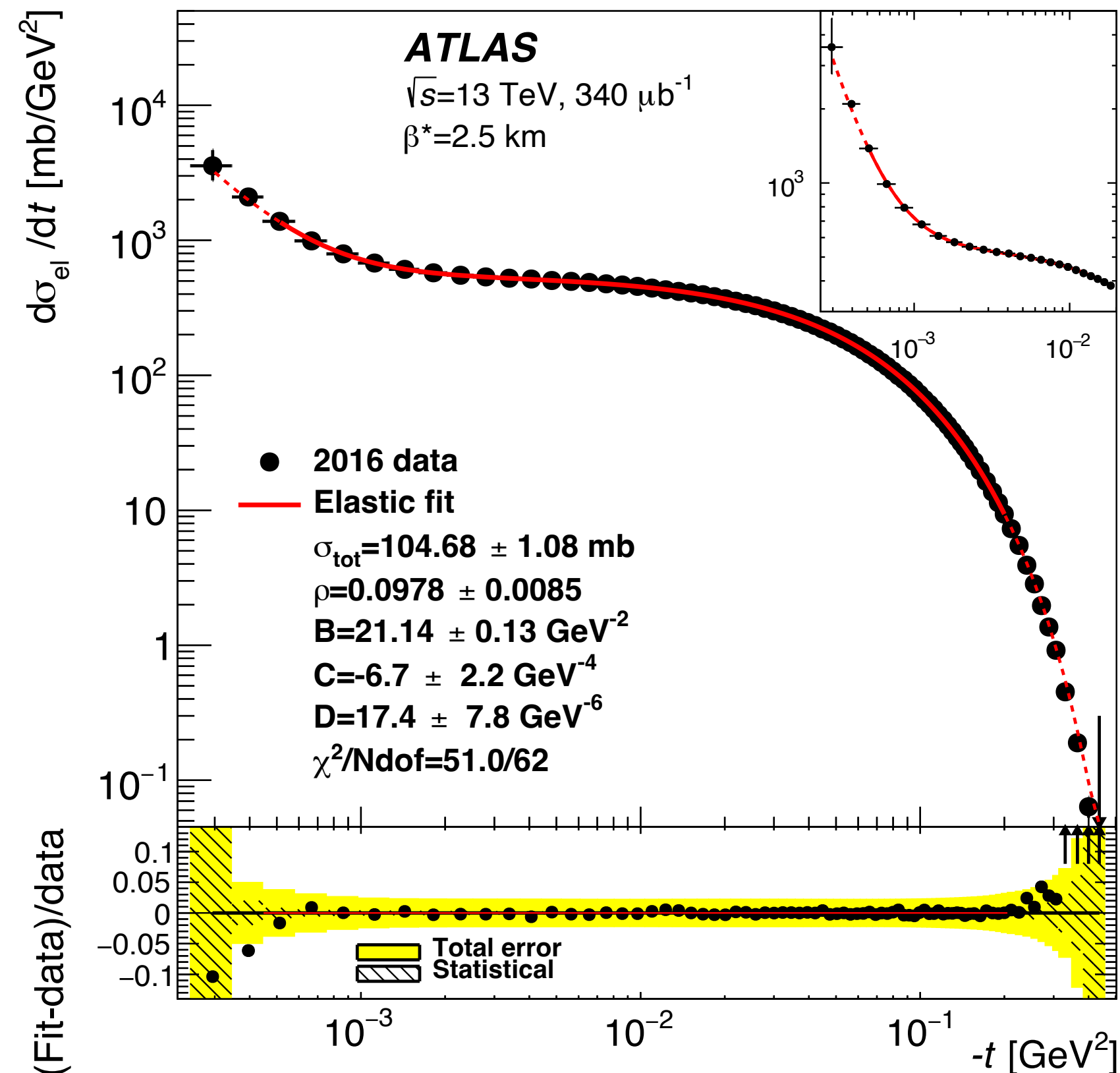

Elastic cross-section measurement

arXiv:2207.12246

From precise $d\sigma/dt$ measurement can extract

- ρ (\Re/\Im of elastic amplitude for $t \rightarrow 0$) 0.098 ± 0.011 Most accurate measurement of
- total cross section (from optical theorem) 104.7 ± 1.1 mb total cross section at high energy
- common models don't accommodate well both measurements at the same time

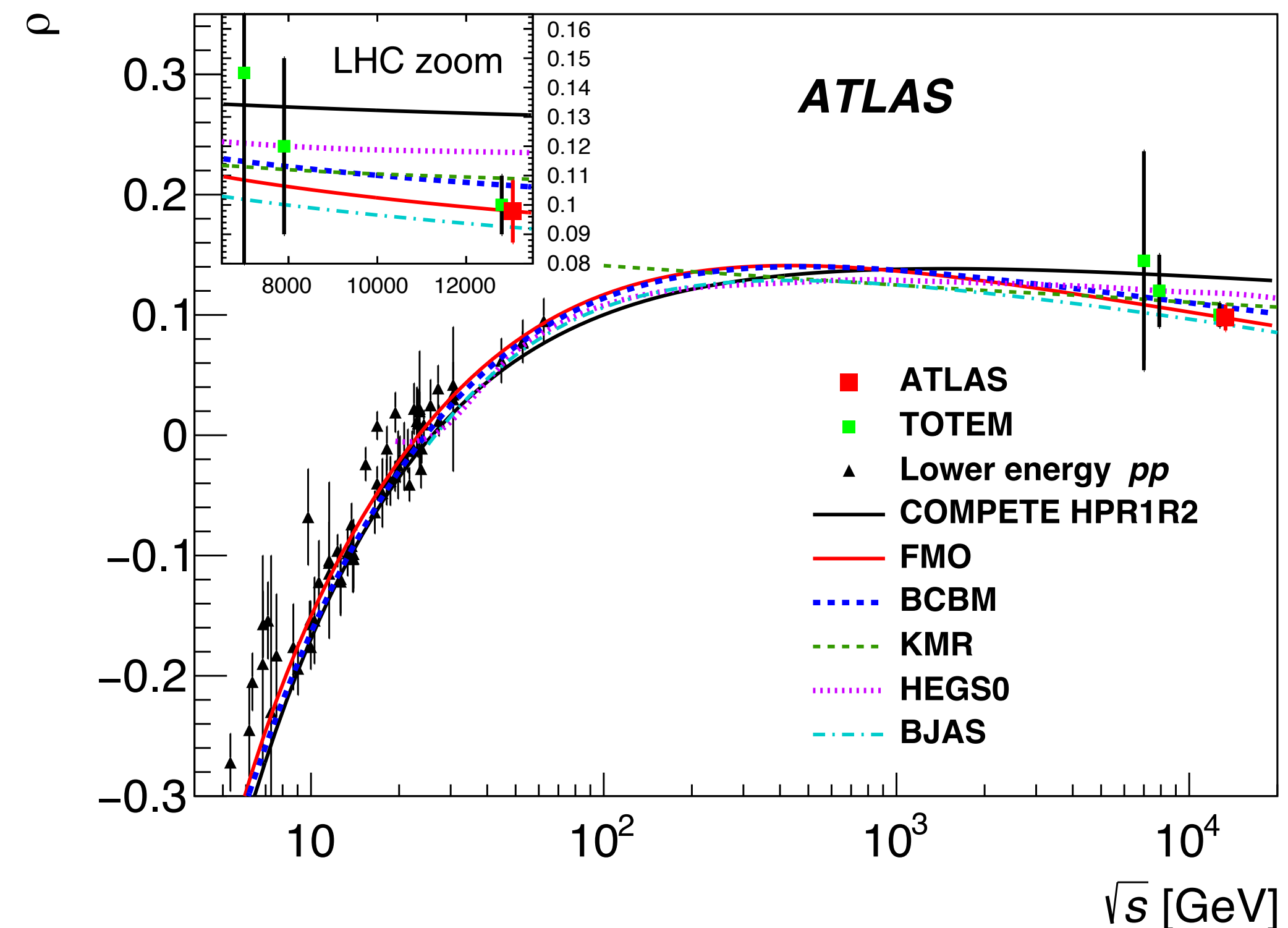
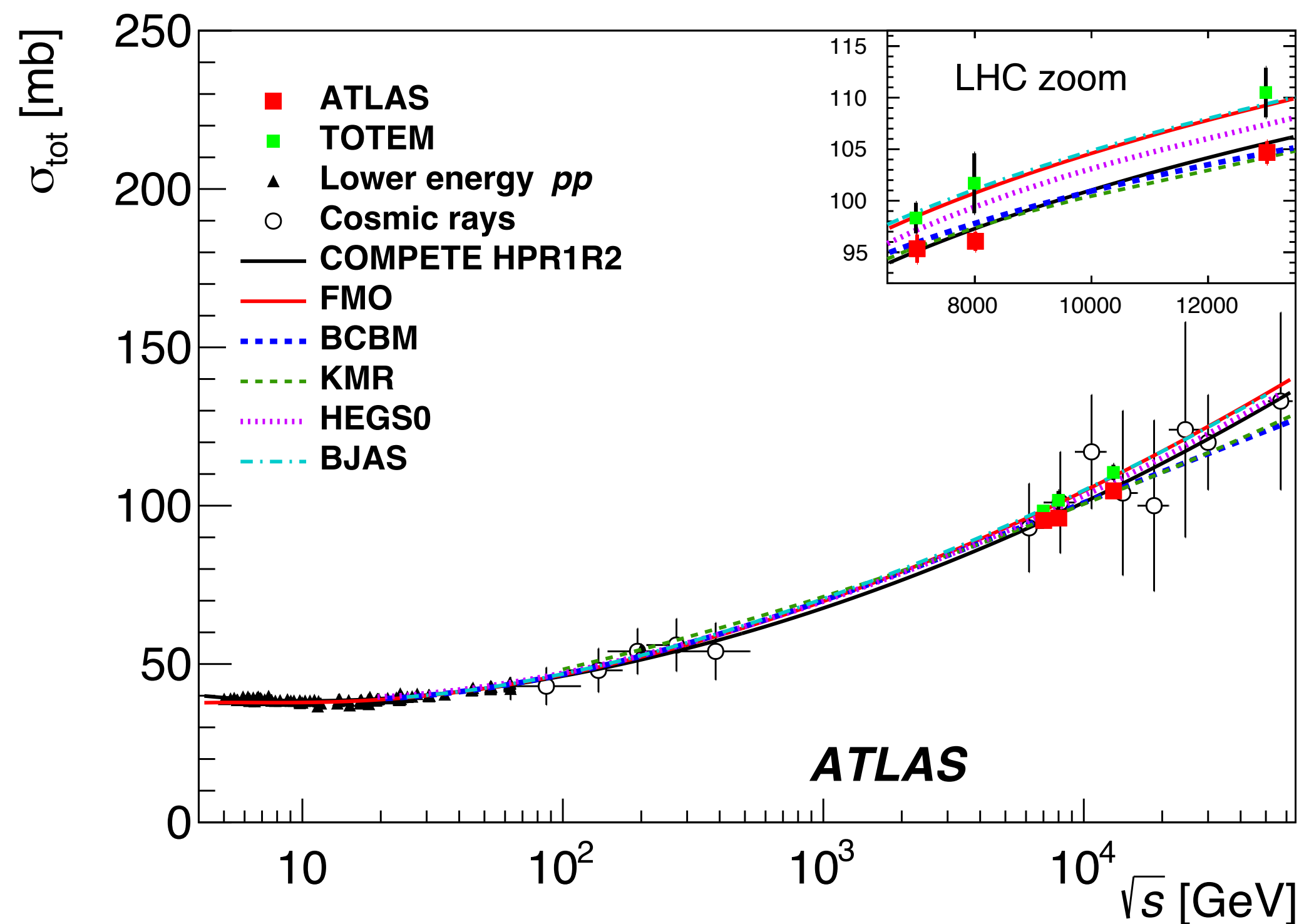

Polarisation in WZ production

ATLAS-CONF-2022-053

Precise studies of rare SM processes

- study W and Z polarisation in WZ events reconstructed in $3\ell+\nu$ decay mode
- joint measurement of W and Z polarisation fraction, using deep neural network
- observation of simultaneous production of long. polarised W and Z bosons with 7.1σ

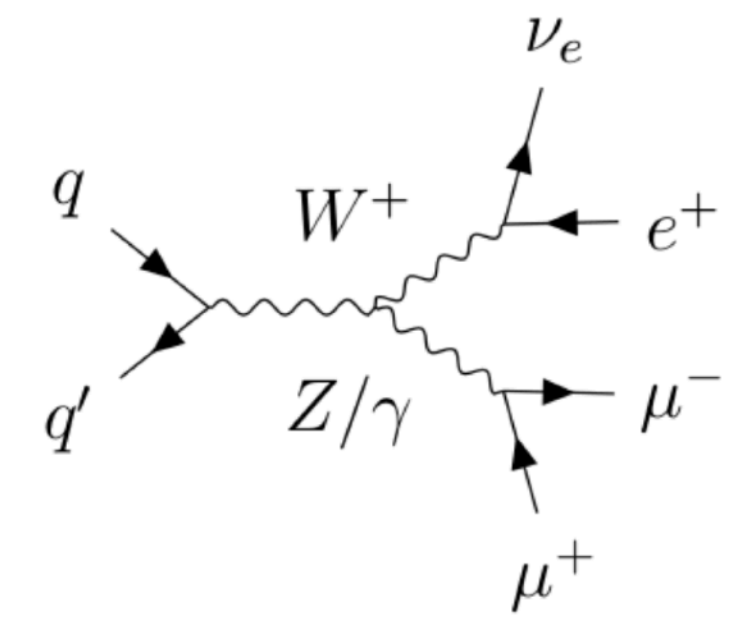
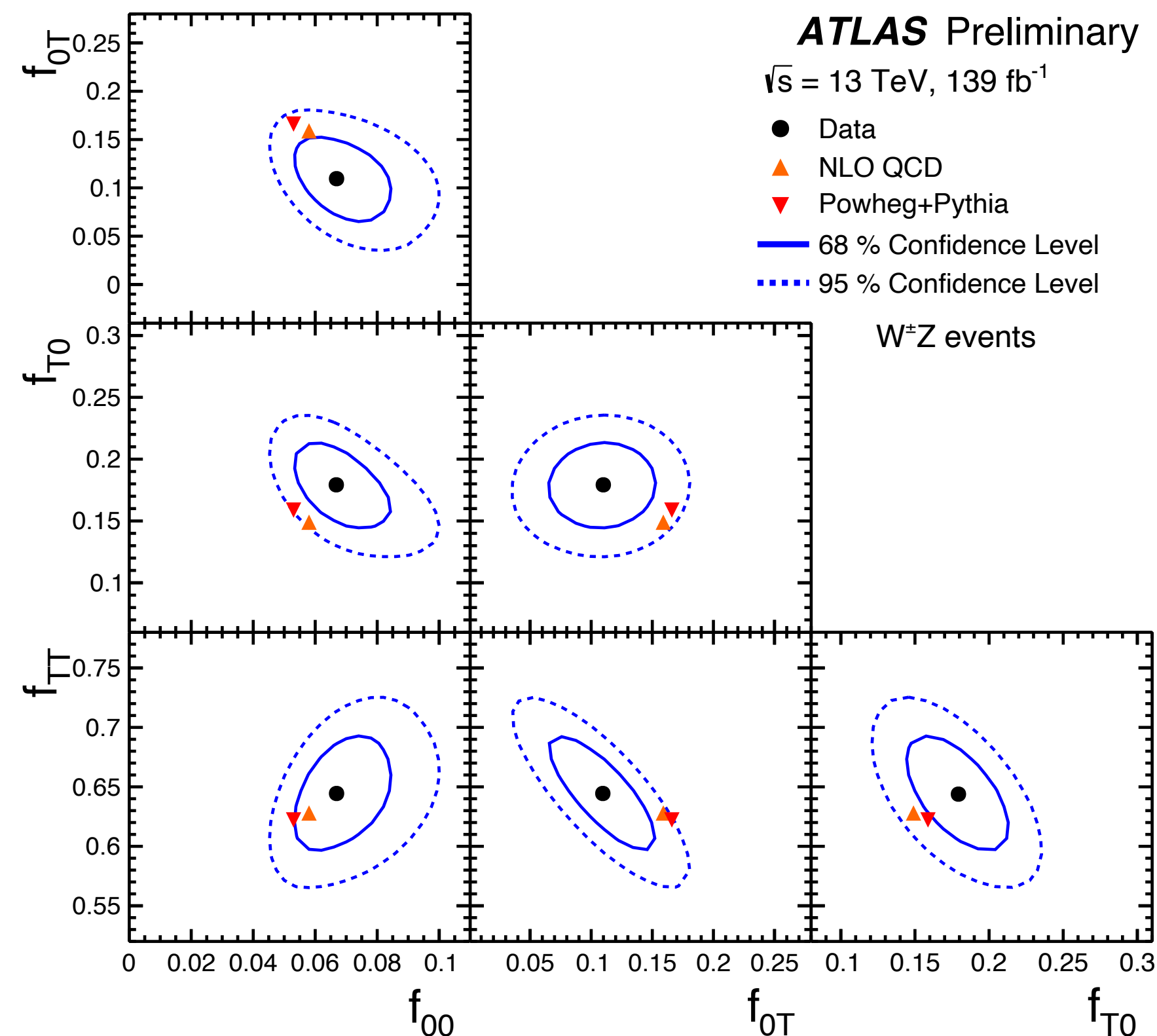
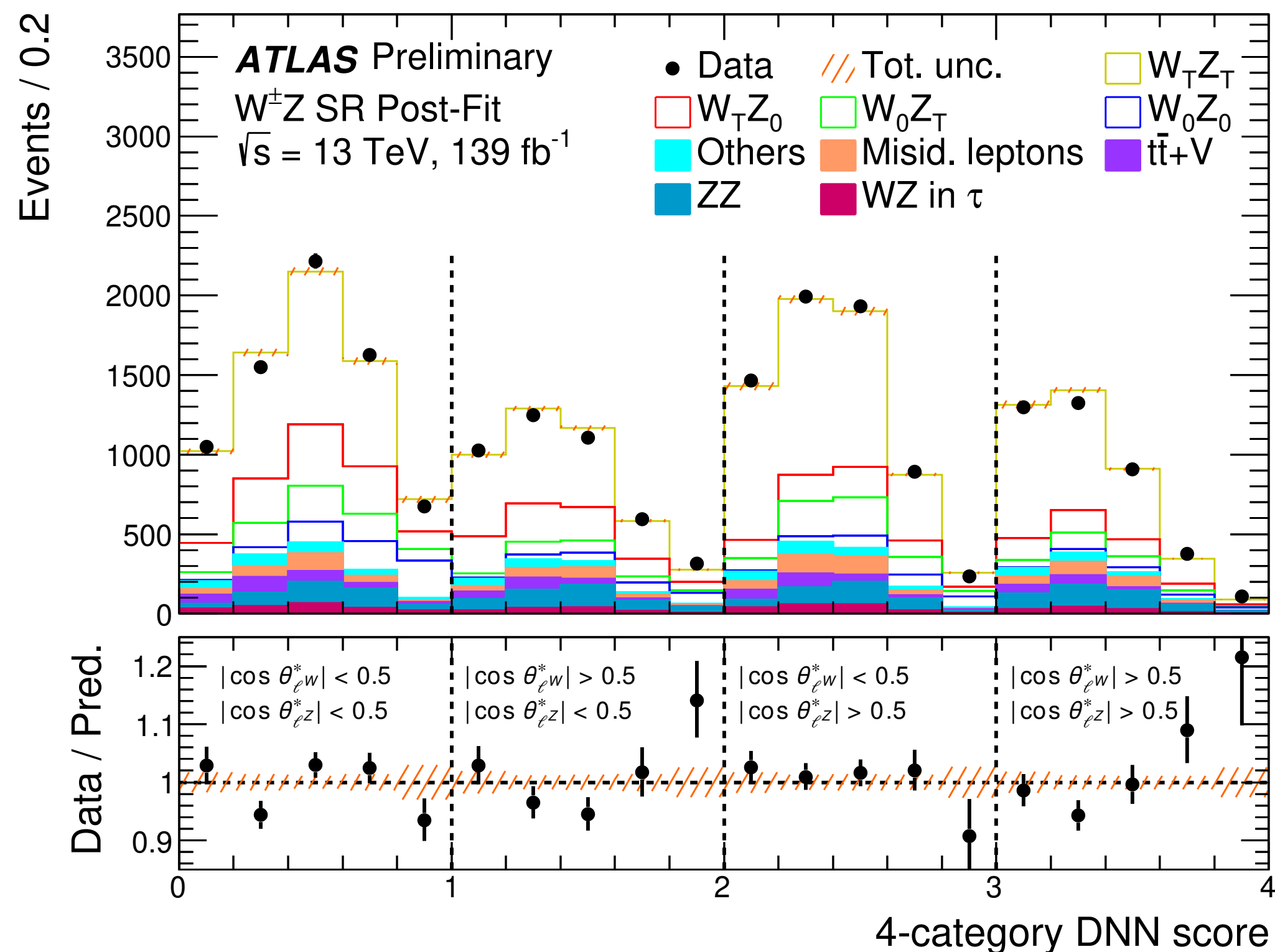

$$f_{00} = 0.067 \pm 0.010$$

Observation of di-charmonium excess

ATLAS-CONF-2022-040

Four-muon final state; motivated by tetraquark

- search for $T_{cc\bar{c}\bar{c}} \rightarrow J/\psi J/\psi \rightarrow 4\mu$ and also in $T_{cc\bar{c}\bar{c}} \rightarrow J/\psi \psi(2S) \rightarrow 4\mu$ (new)
- background from single-parton and double-parton scattering
- see large structures near threshold as well as narrow resonance at 6.9 GeV
- confirming LHCb observation in di- J/ψ

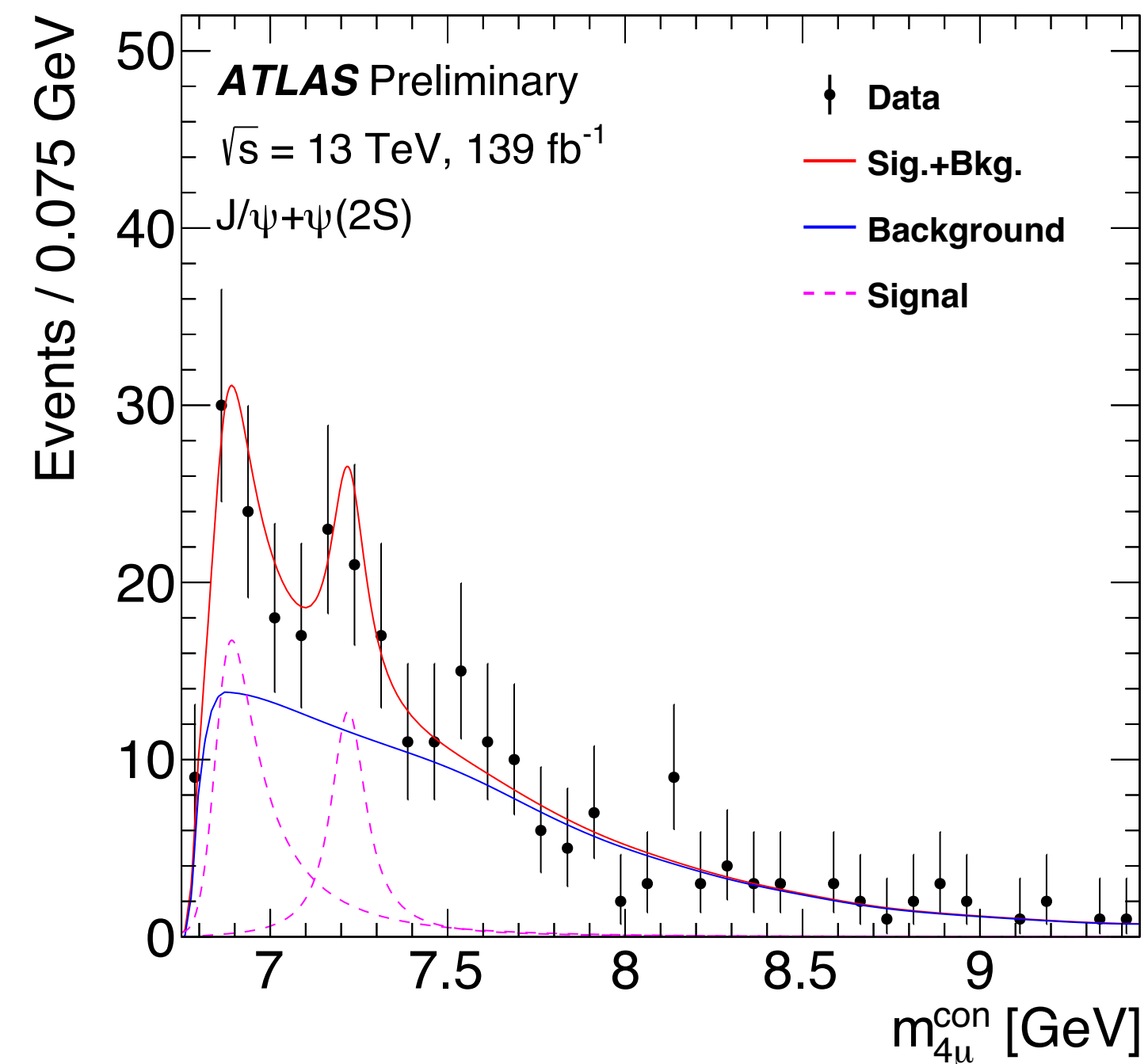
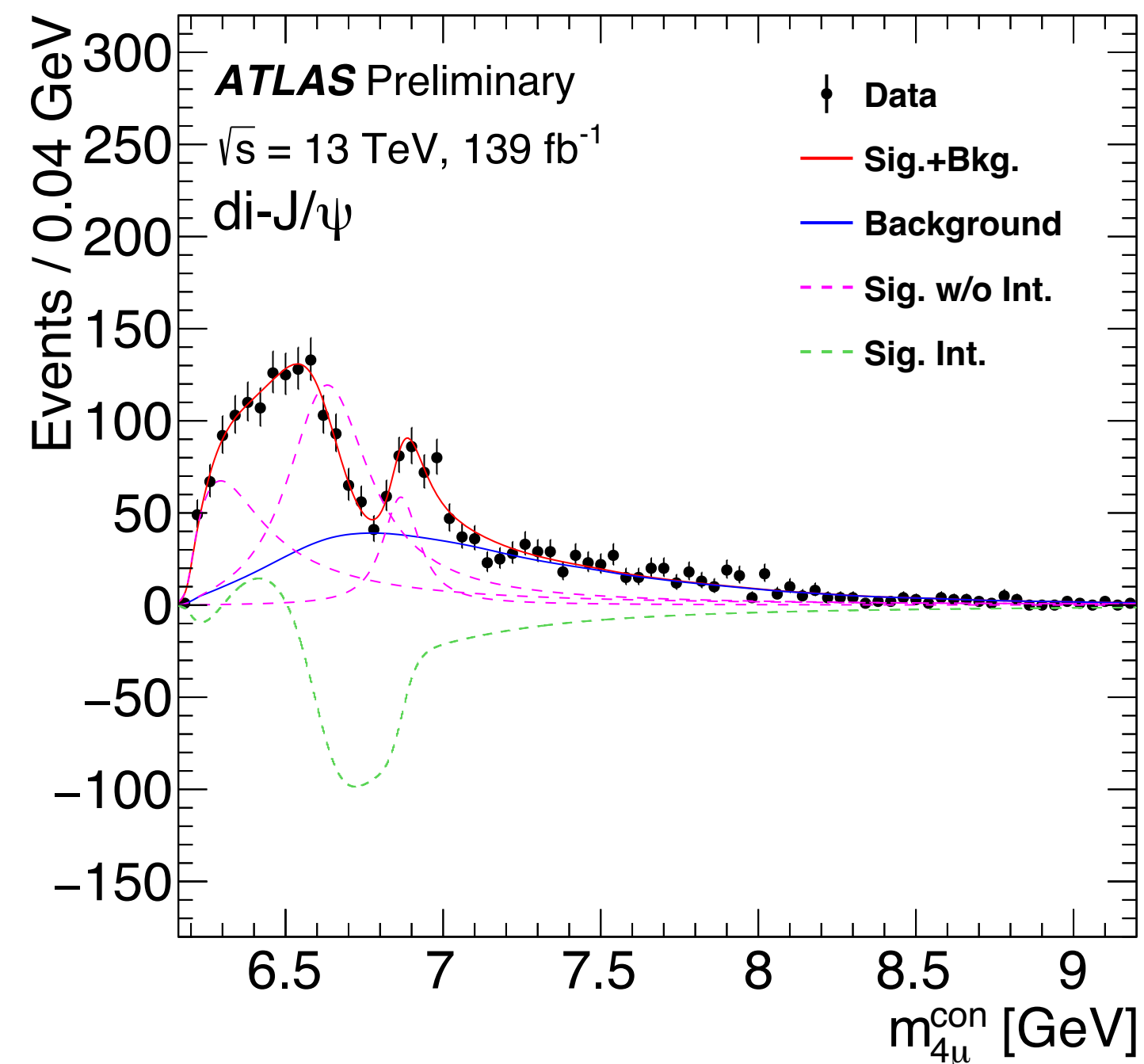

Top-quark cross-section measurements

arXiv:2207.01354

Pair-production cross section @ 5.02 TeV

- 260 pb⁻¹ dataset recorded in Run-2, dilepton and ℓ +jets final states

$$\sigma(t\bar{t}) = 67.5 \pm 0.9 \text{ (stat.)} \pm 2.3 \text{ (syst.)} \pm 1.1 \text{ (lumi)} \pm 0.2 \text{ (beam) pb} \quad 4\% \text{ precision !}$$

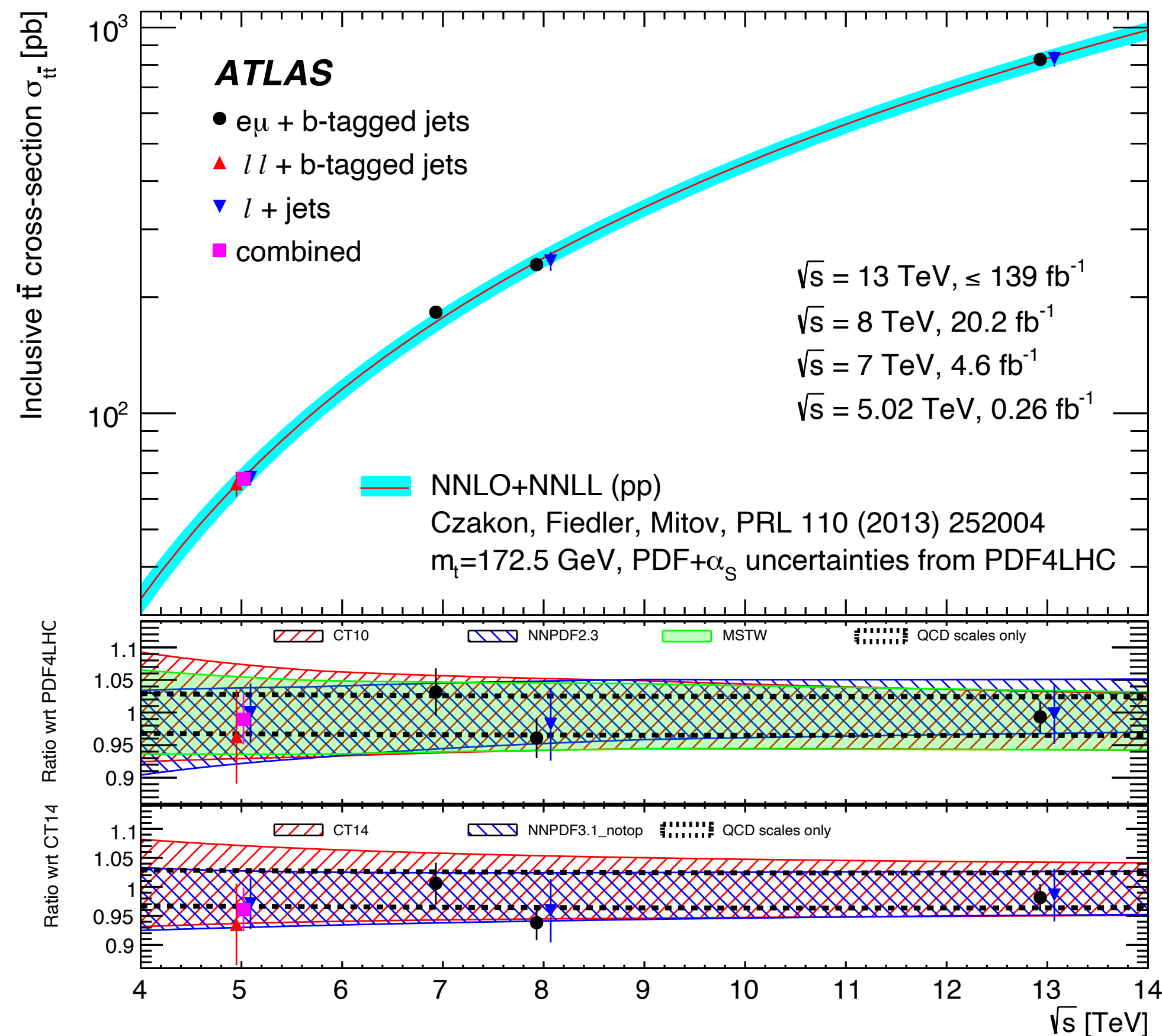

Prediction $68.2 \pm 4.8 \pm 2.0 \text{ pb}$

- result is in excellent agreement with the NNLO-NNLL prediction
- gluon pdf constraint improves prediction of ggF Higgs production

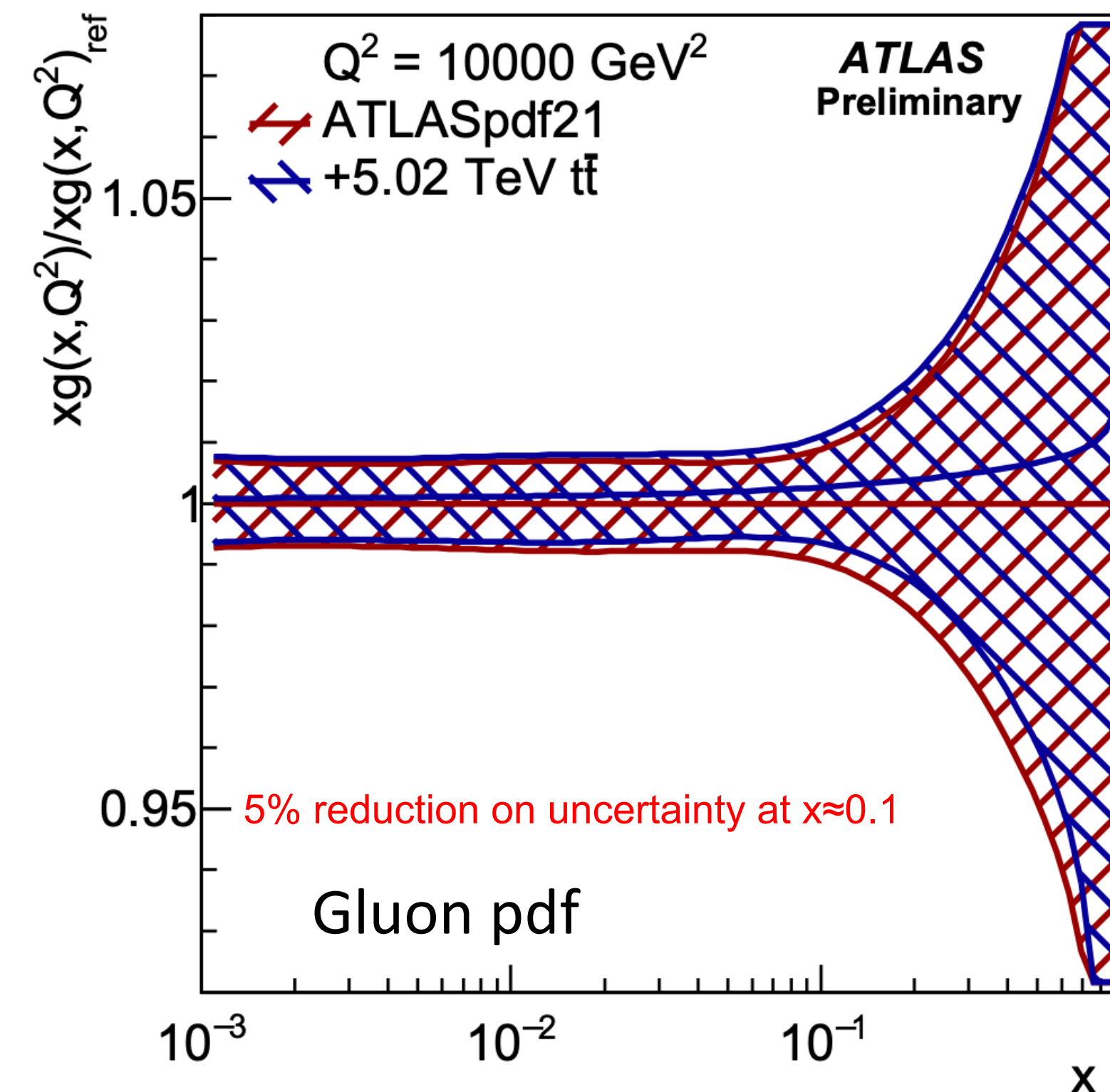

Single top + photon observation

Associated t or $t\bar{t}$ + $\gamma/Z/H \rightarrow$ constraints of t ewk couplings

- measured: $\sigma_{\text{fid}}(t\gamma q) = 580 \pm 19$ (stat.) ± 63 (syst.) fb
- predicted: 406^{+25}_{-32} fb
- dominant systematics: $t\bar{t}\gamma$ modelling and jets/ E_T^{miss}

ATLAS-CONF-2022-013

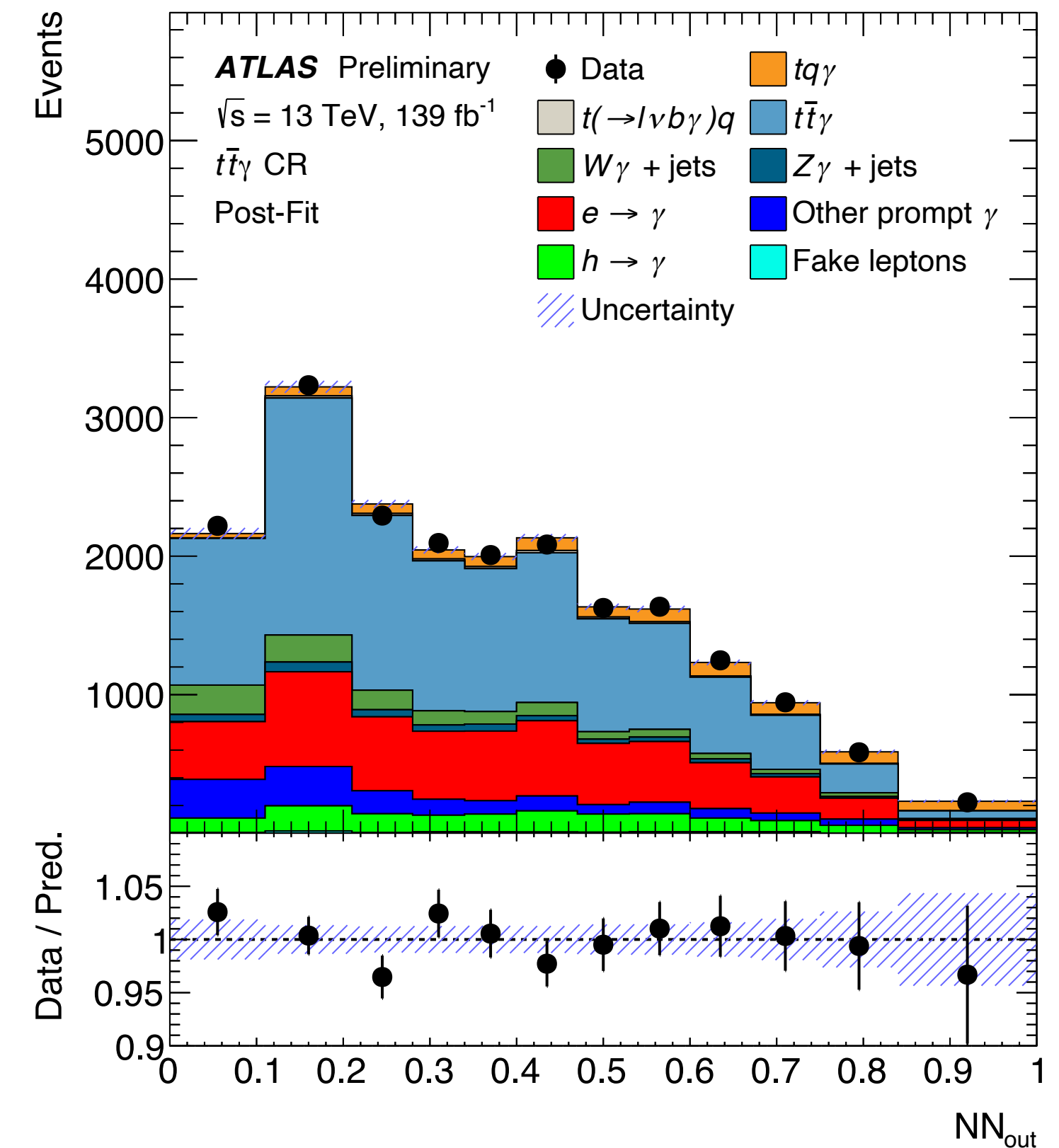
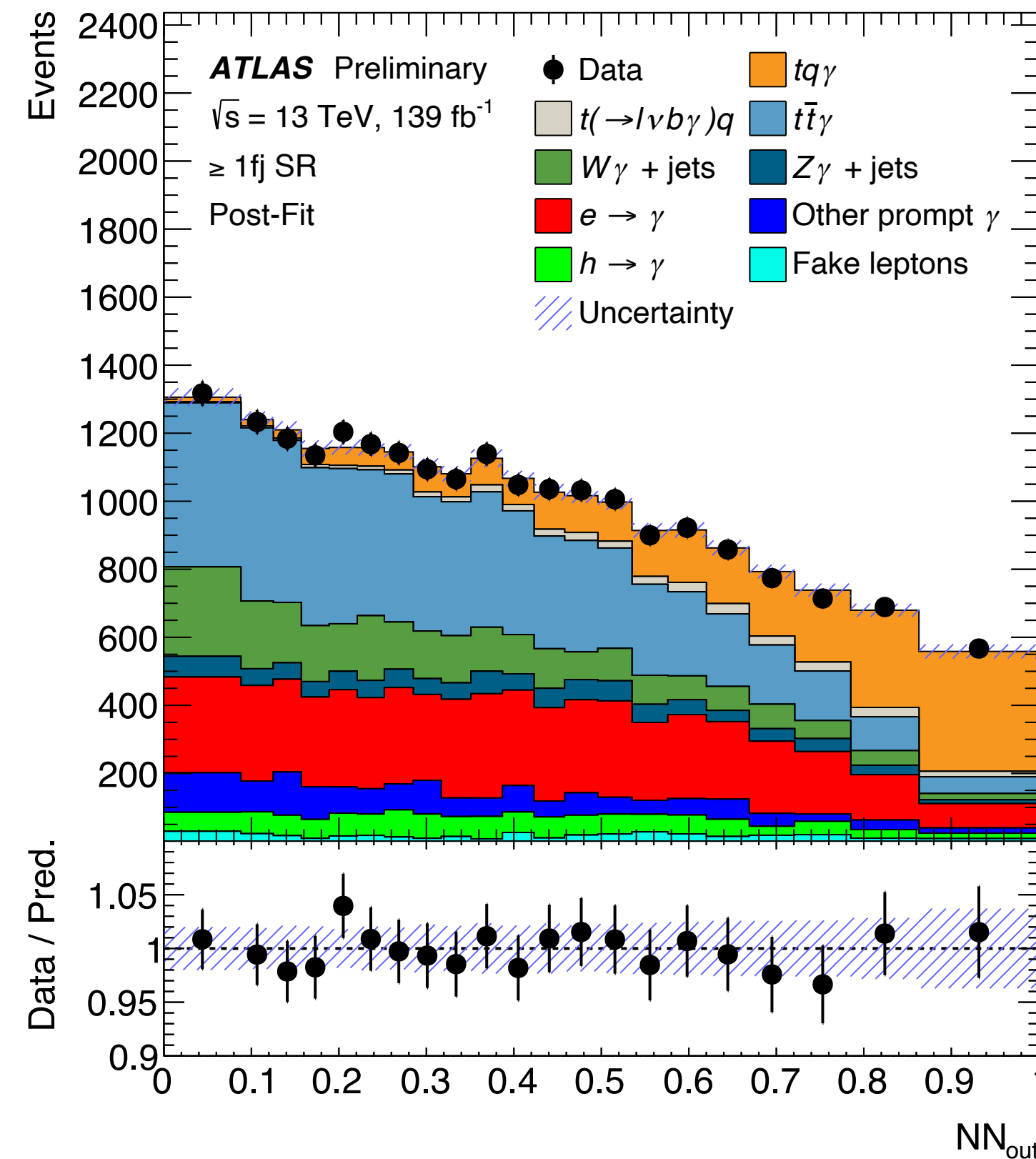
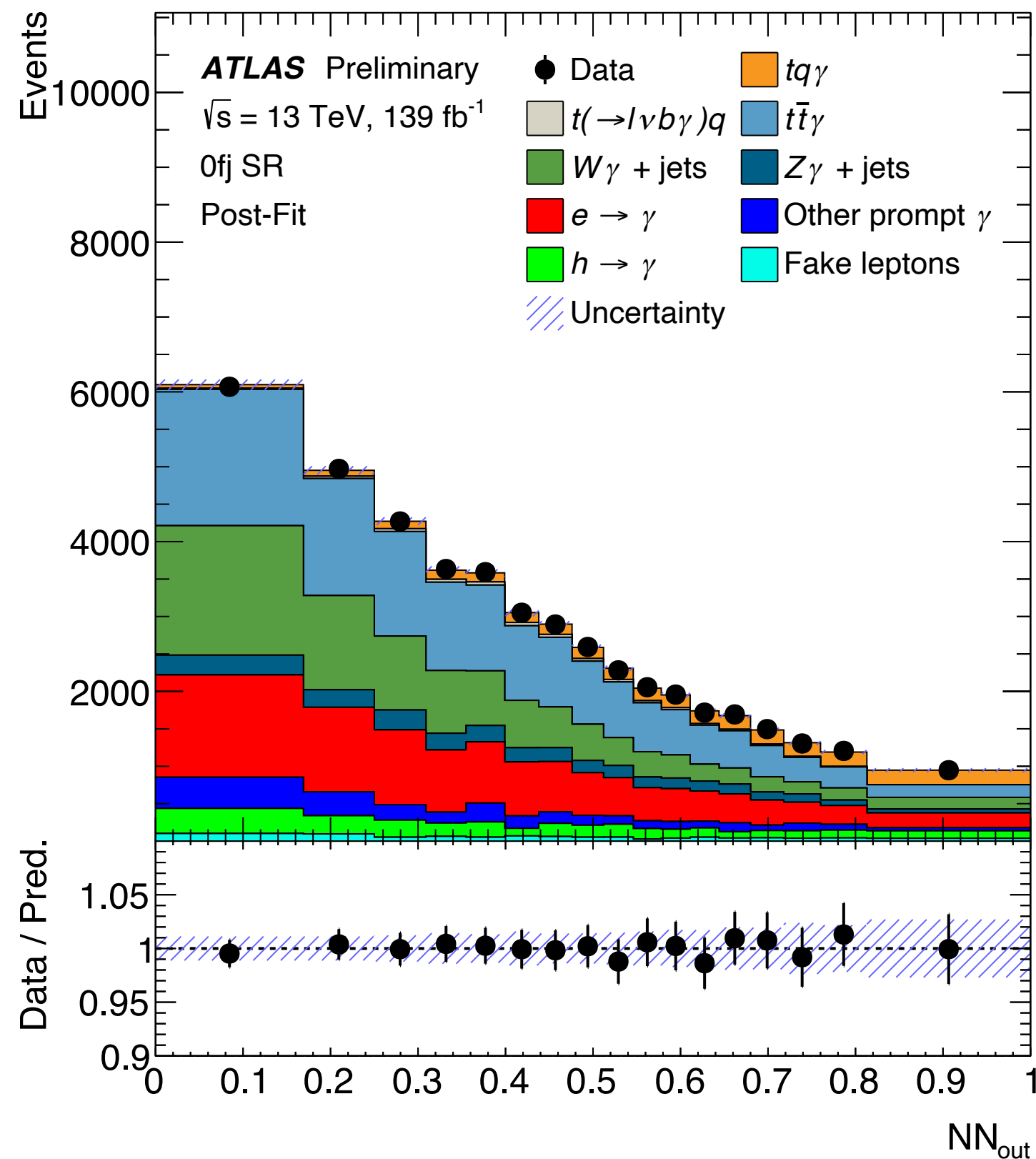
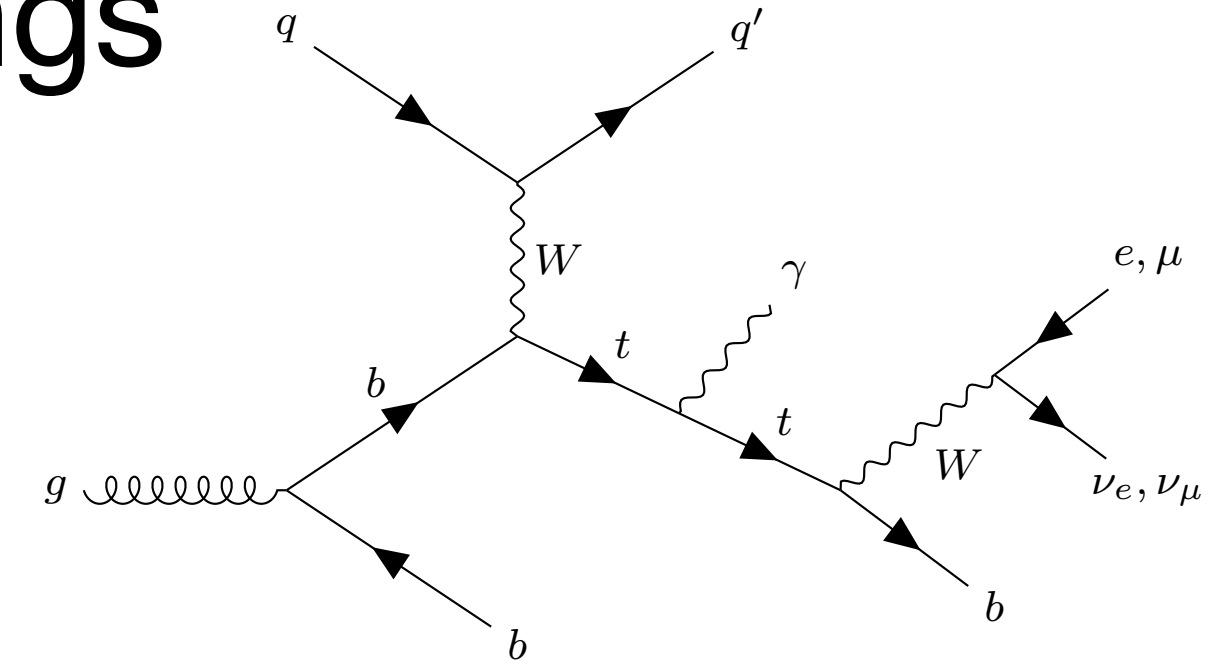

Single top s-channel production

ATLAS-CONF-2022-030

Most difficult single-top channel at LHC

- first time measured at 13 TeV
- matrix-element based likelihoods for signal/bkg
- evidence at 3.3σ (3.9σ exp.)
- $\sigma = 8.2^{+3.5}_{-2.9}$ pb

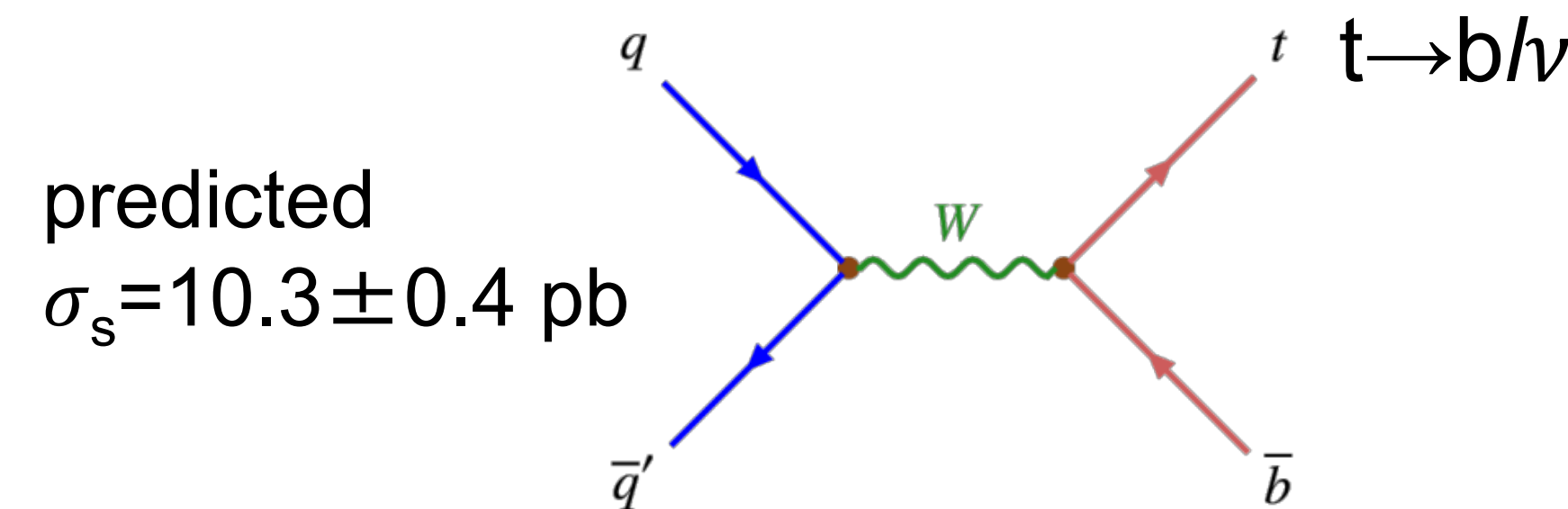

$t\bar{t}$ validation region

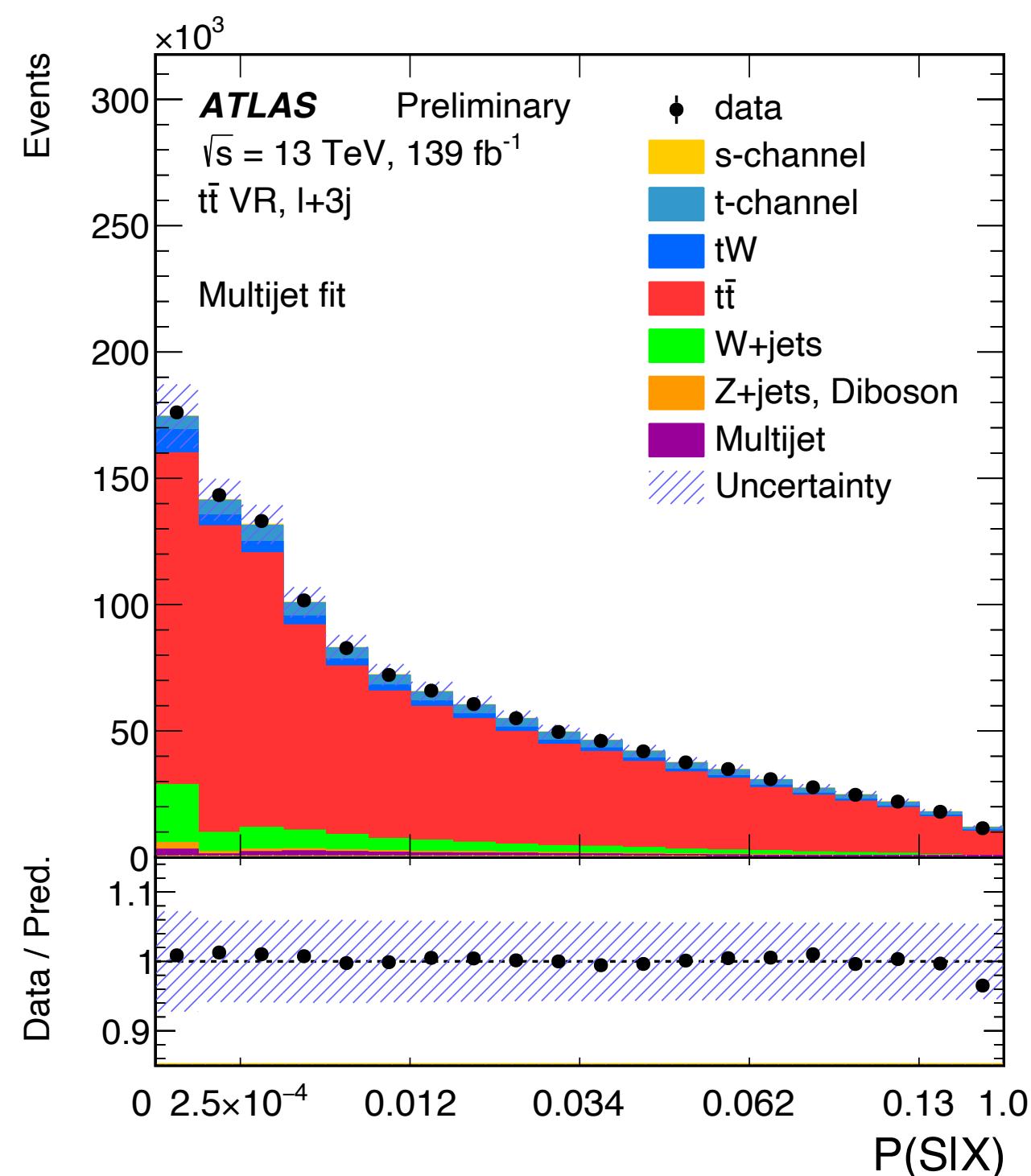

fit to signal region

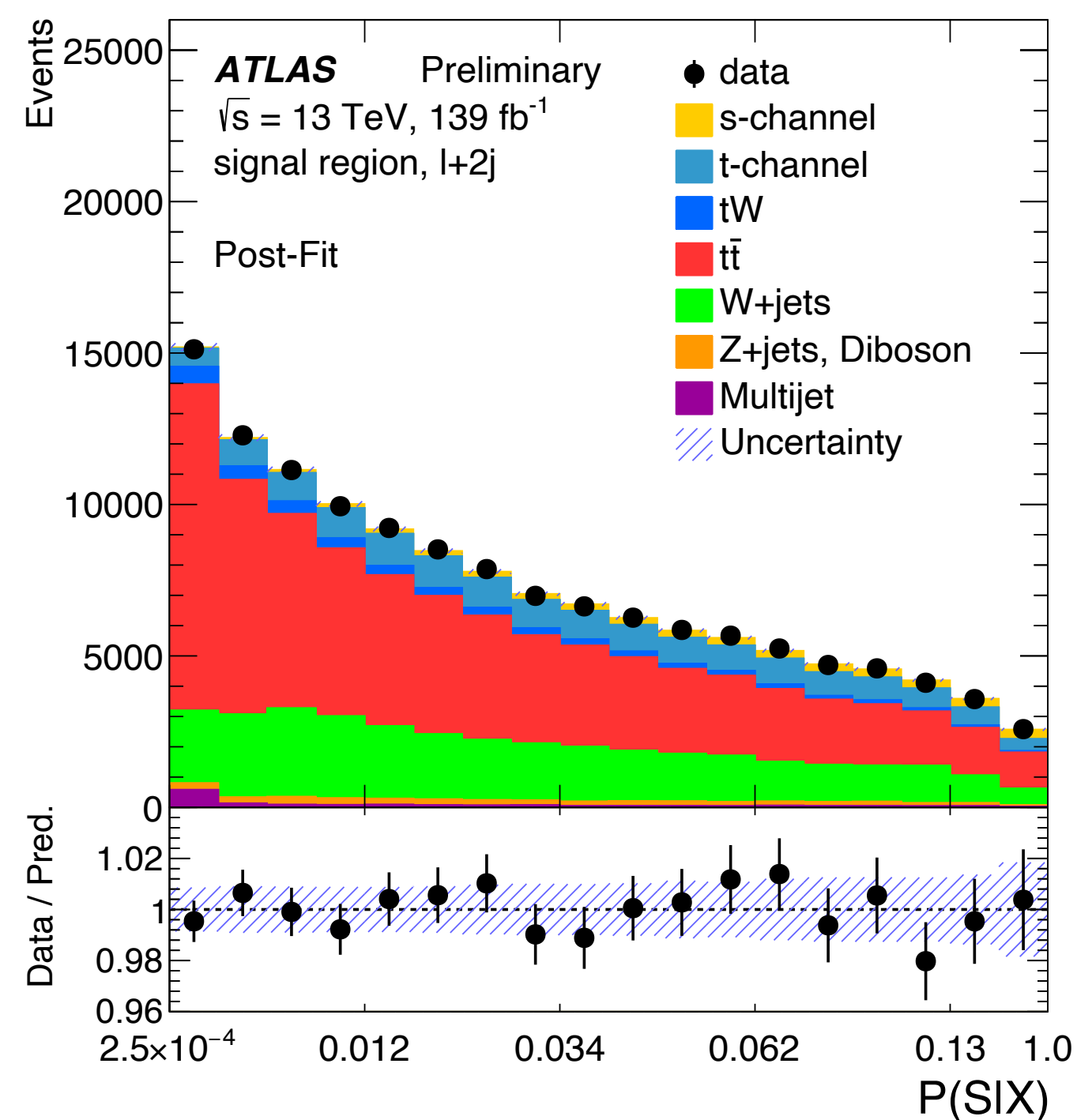

summary single top

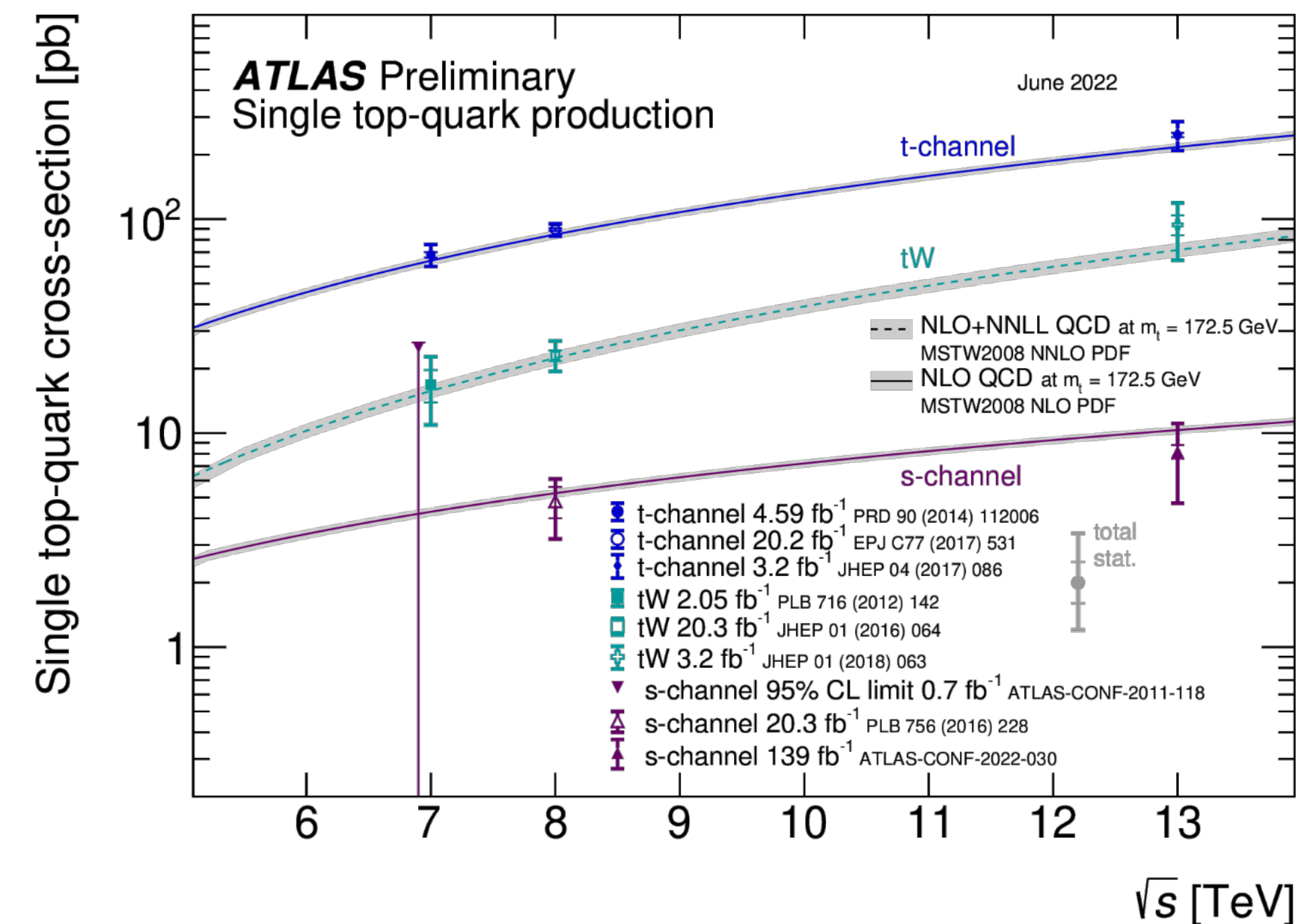

Measurement of 4t production cross section

Combination of 1ℓ / 2ℓ OS and 2ℓ SS / 3ℓ

- $\sigma_{t\bar{t}t\bar{t}} = 24_{-6}^{+7}$ pb with 4.7σ (2.6σ exp.) significance

[JHEP 11 \(2021\) 118](#)

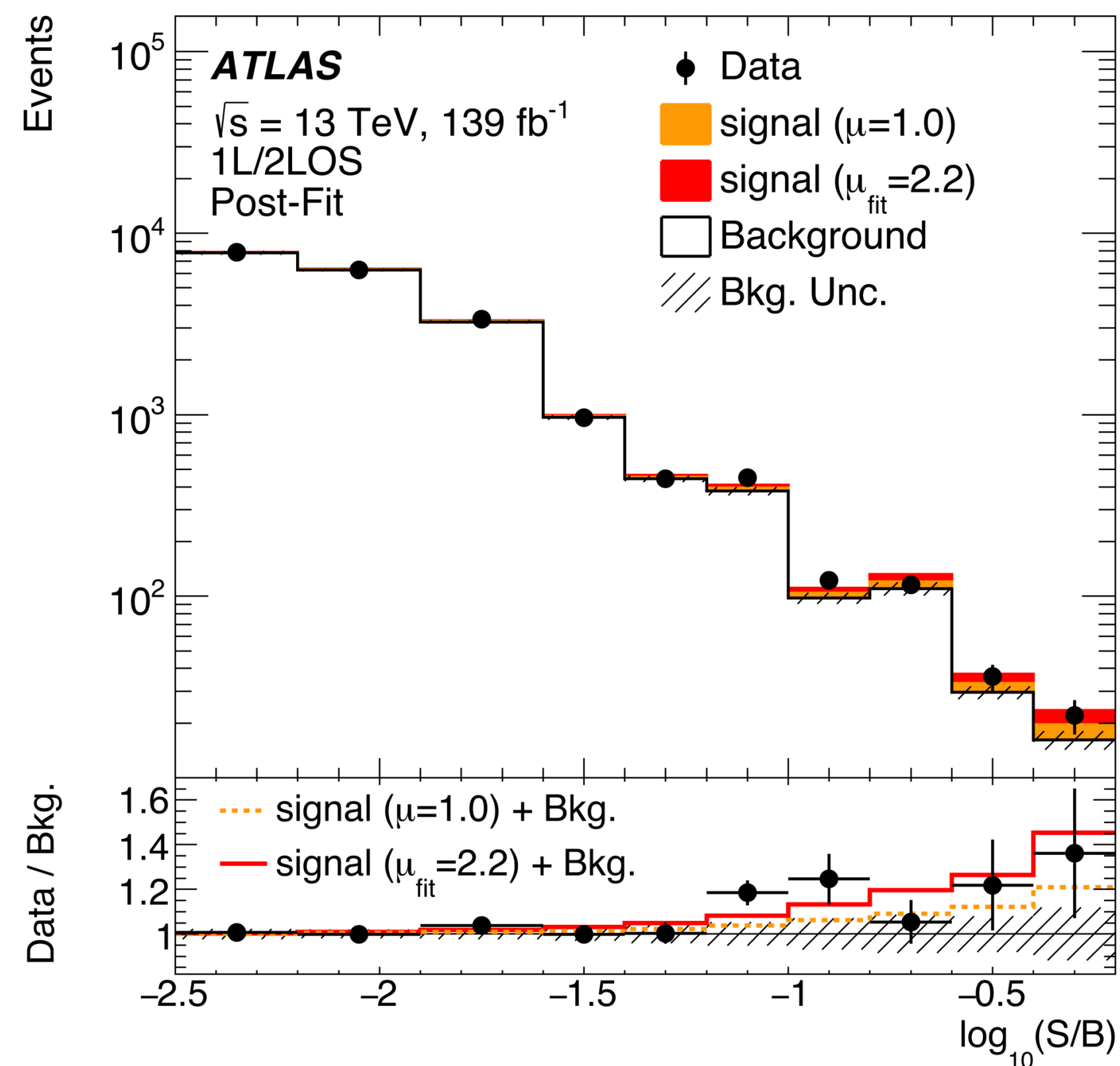
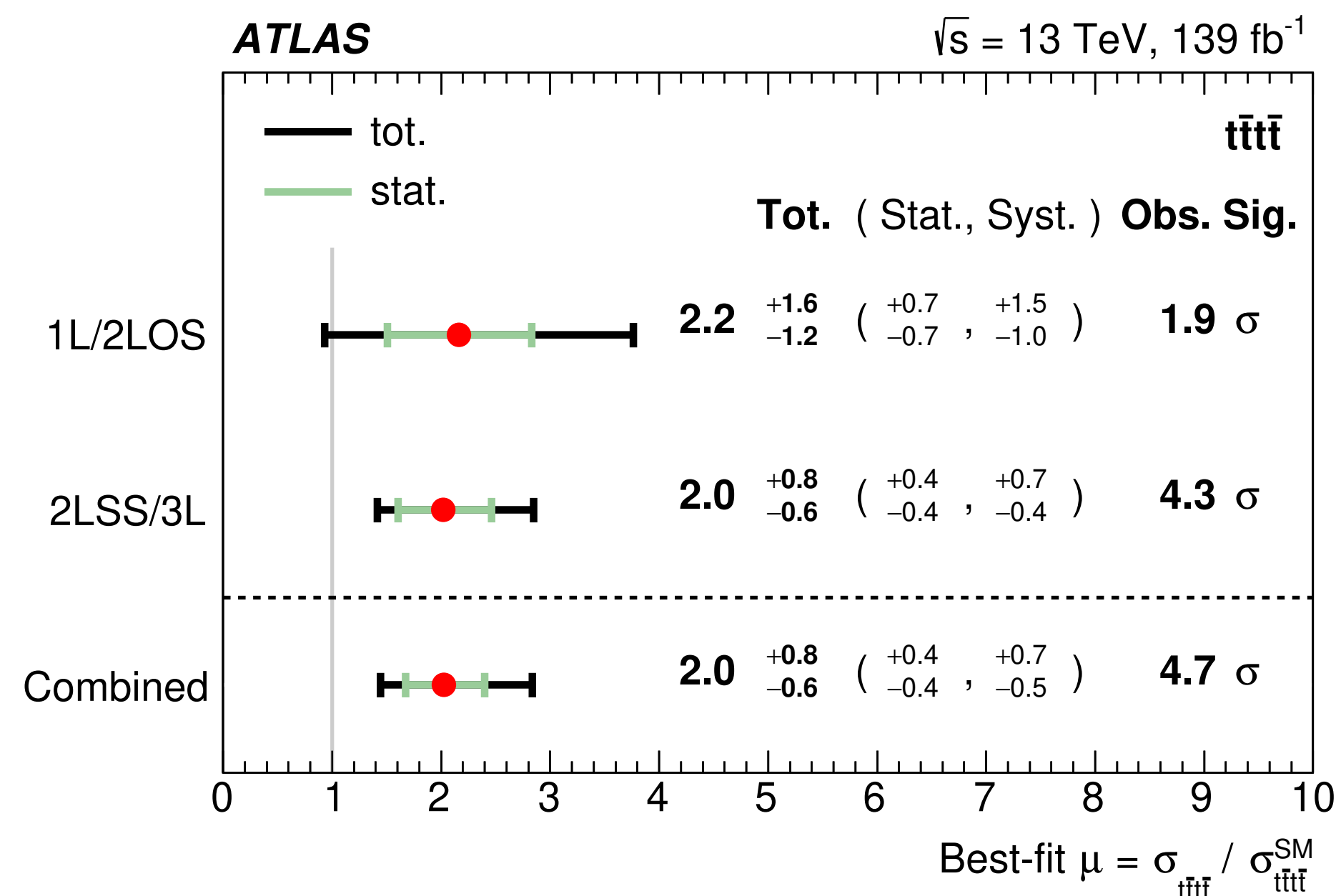
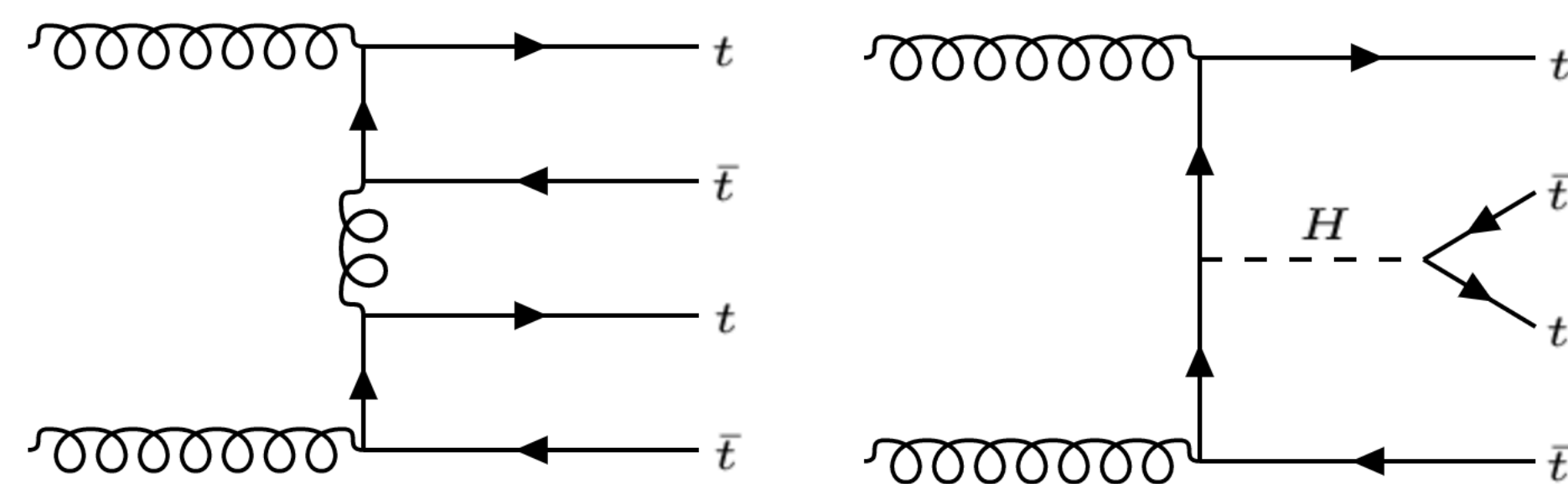

To improve results, will need

- better $t\bar{t}$ +HF modelling for 1ℓ / 2ℓ OS
- better $t\bar{t}W$ modelling for 2ℓ SS / 3ℓ

Higgs-boson physics

Higgs plays a key role in SM, discovered in Run-1 by ATLAS and CMS

- 2022 is the 10th anniversary of the Higgs-boson discovery!

Run-2, 30x more Higgs bosons recorded by the ATLAS detector

- allows for precise measurements of cross sections, couplings and properties, search for rare decay modes, and test phase space that hasn't been probed before.

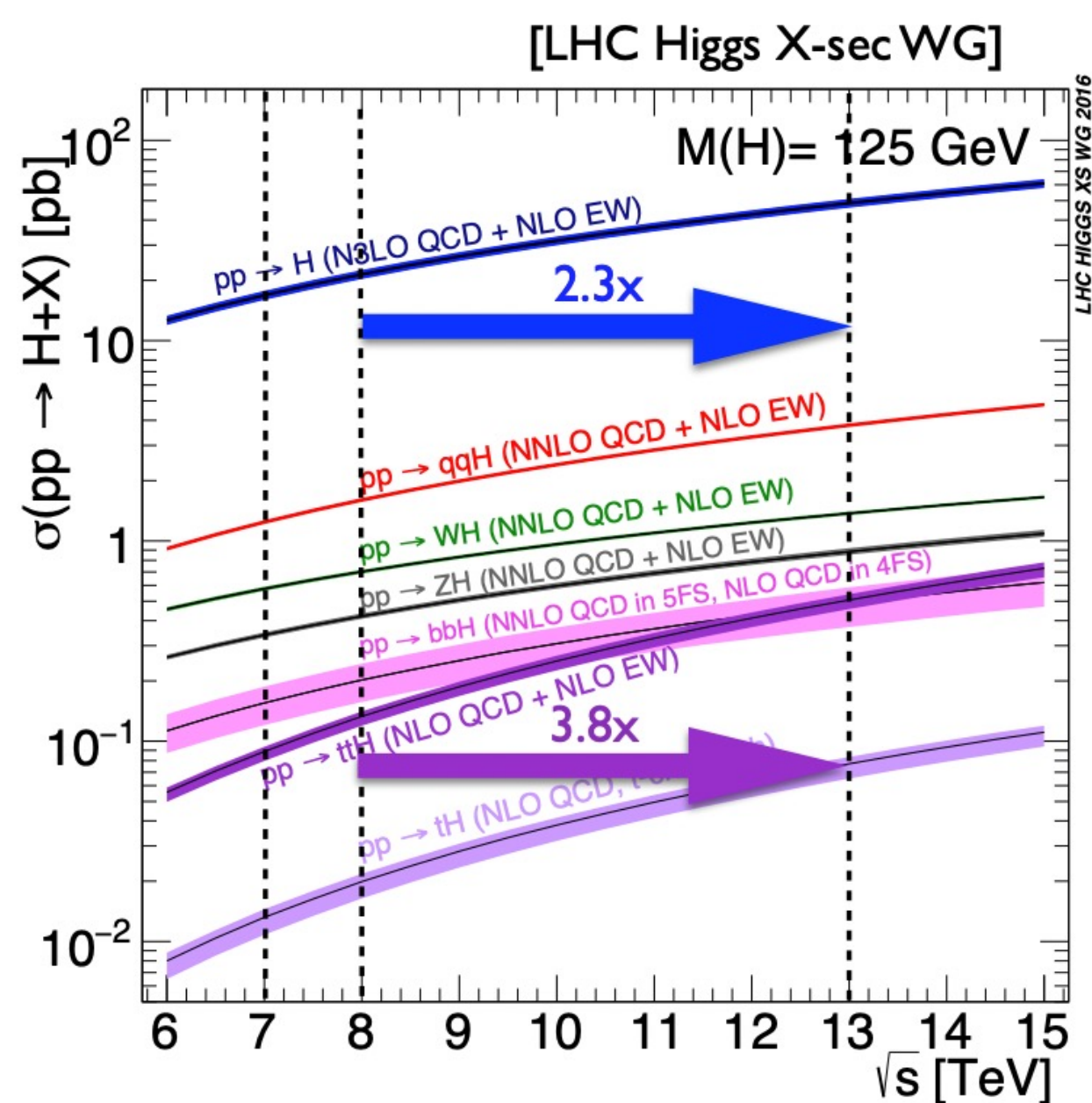

Significant increase in production date from Run-1 to Run-2

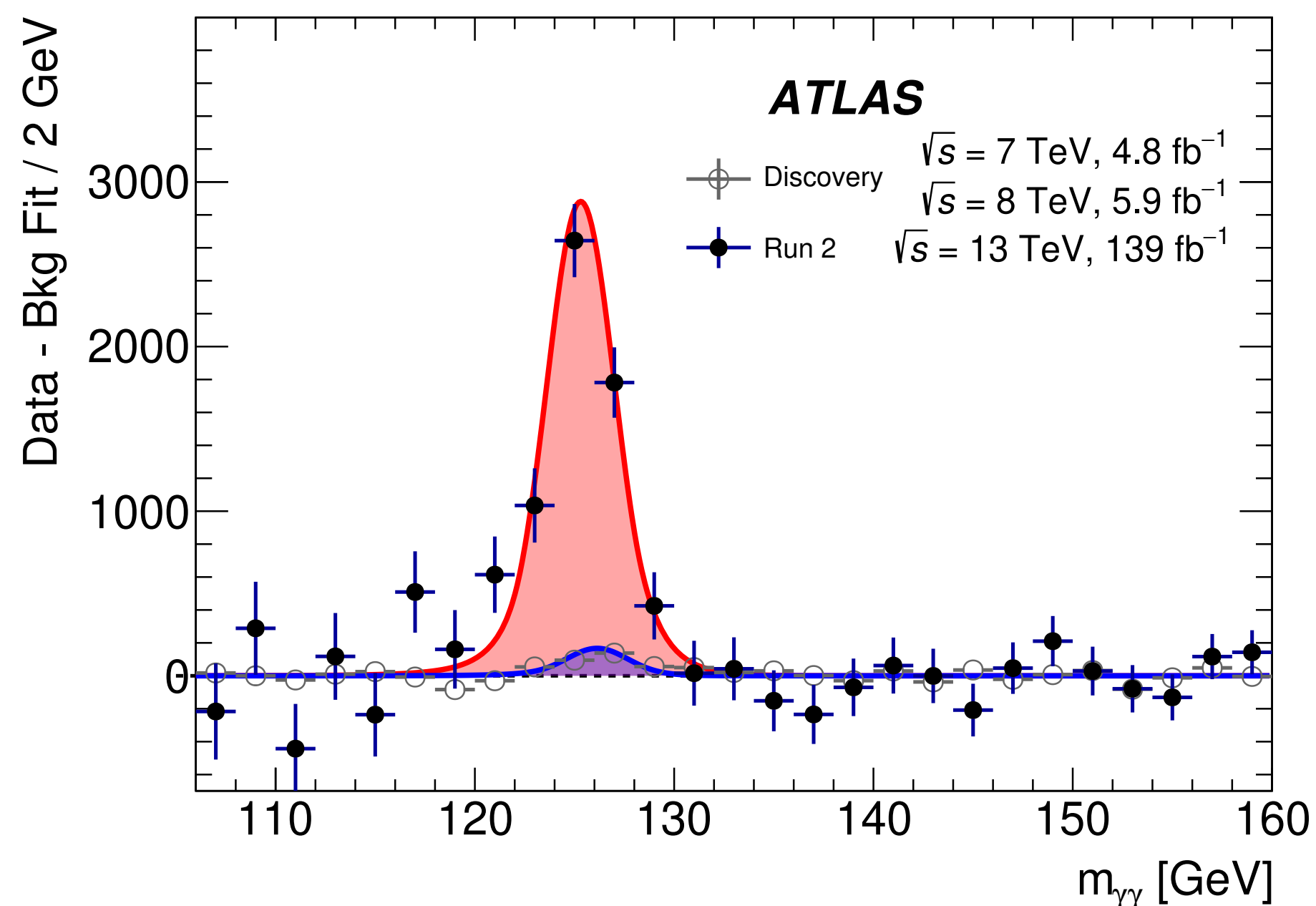

Comparison of $m_{\gamma\gamma}$ spectrum between discovery and full Run-2 datasets

Higgs-boson coupling measurements

Nature 607 (2022) 52

Total cross section / Standard-Model prediction

- $\mu = 1.05 \pm 0.06 = 1.05 \pm 0.03$ (stat.) ± 0.03 (exp.) ± 0.04 (sig th.) ± 0.02 (bkg th.)
- benefits also from reduced theory uncertainty

Measurements per production mode x decay channel

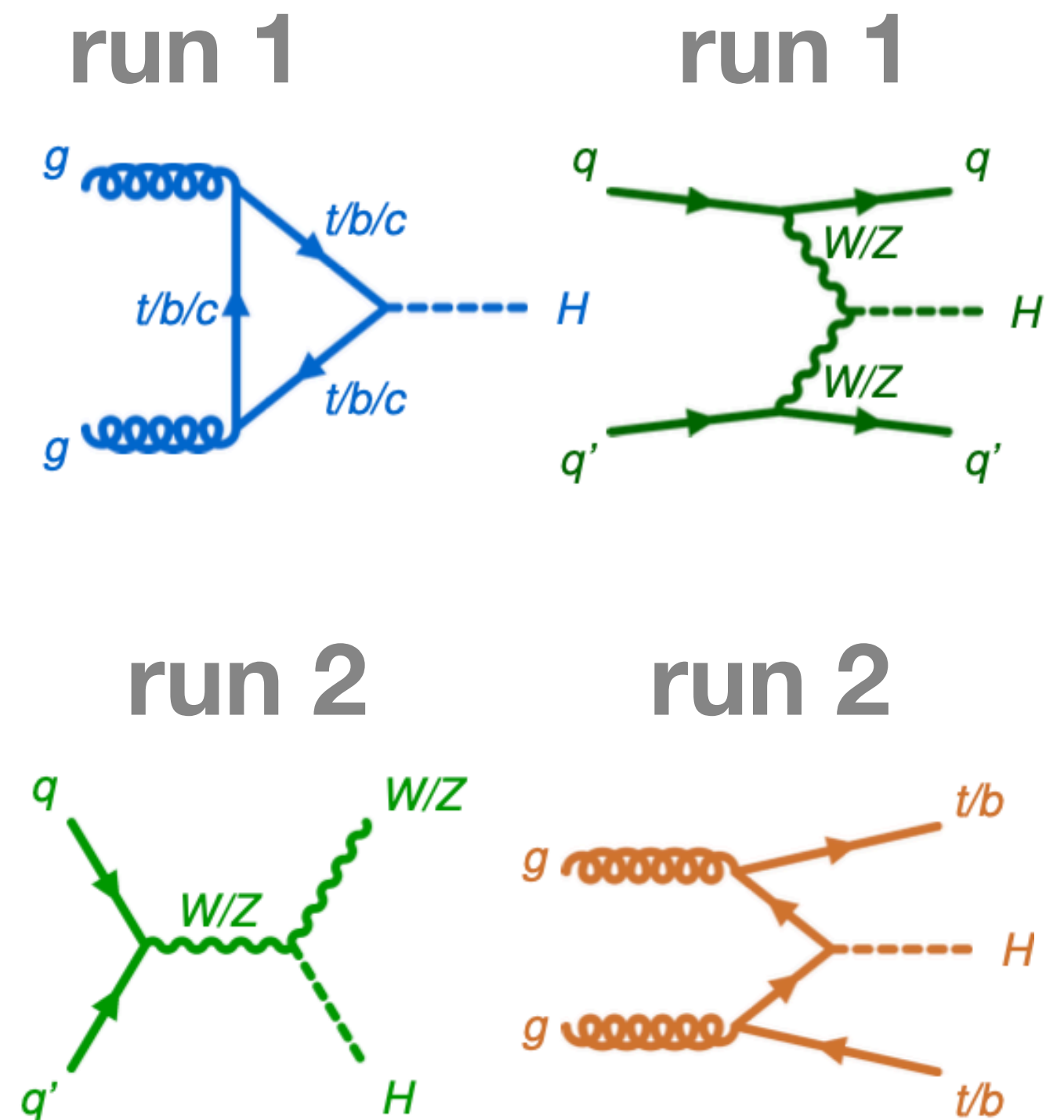
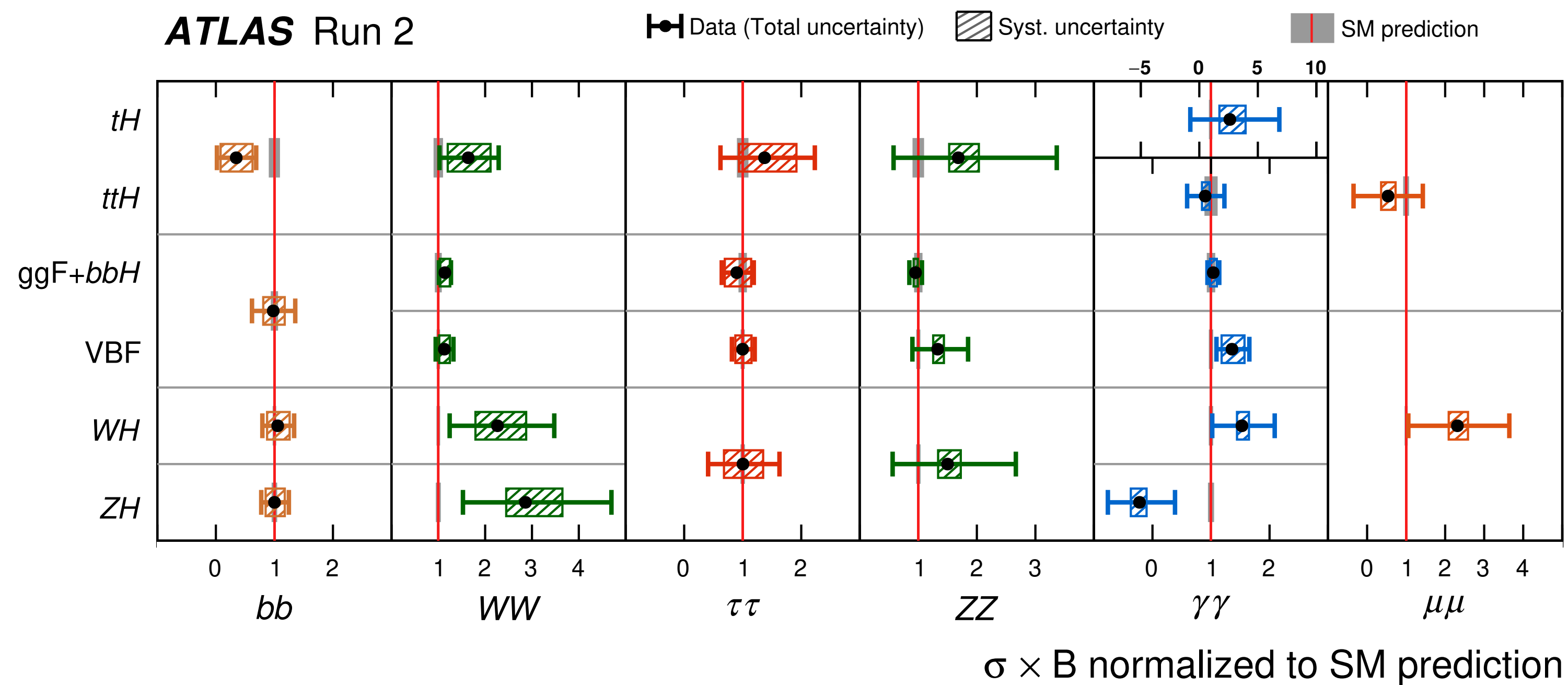

Higgs-boson coupling measurements

Nature 607 (2022) 52

Coupling modifier interpretation

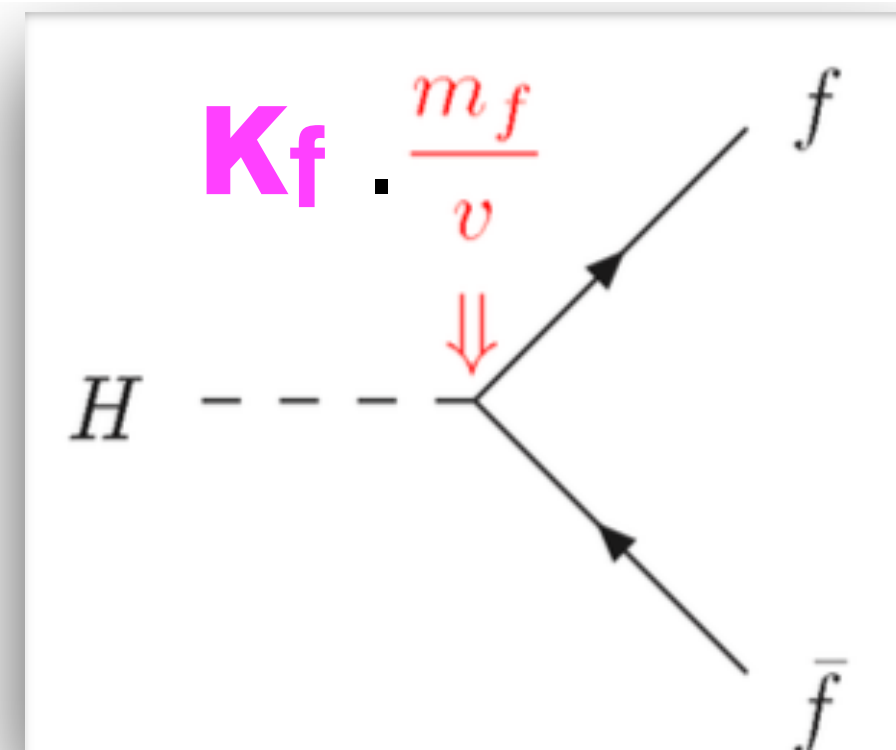
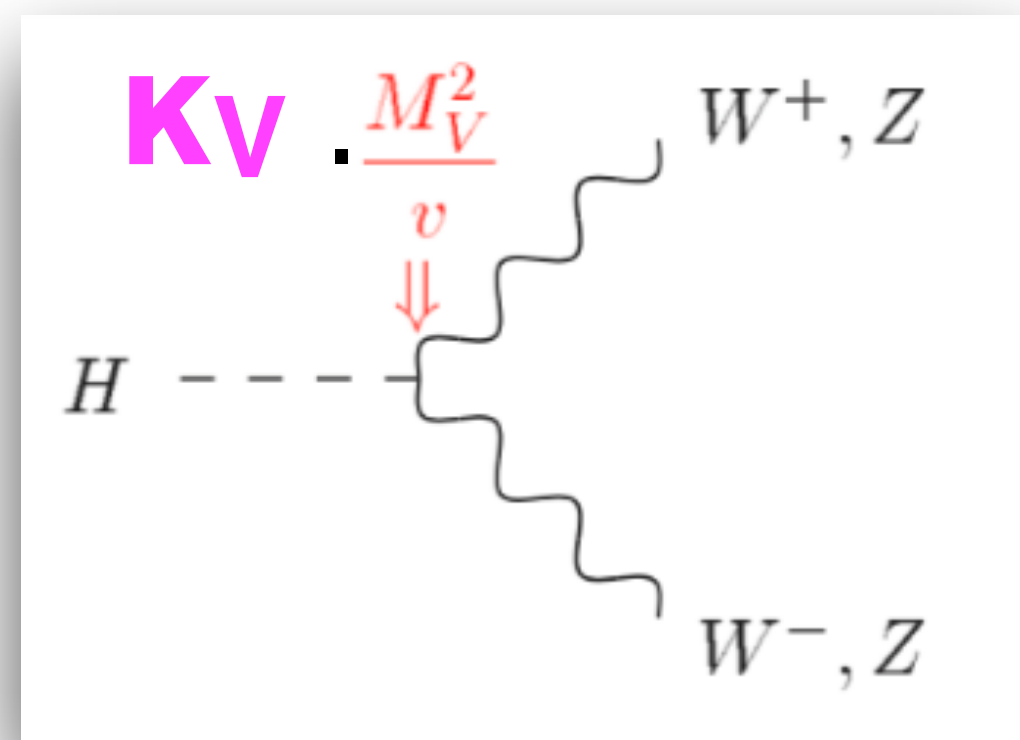

$$\sigma(i \rightarrow H \rightarrow f) = \sigma_i B_f = \frac{\sigma_i(\kappa) \Gamma_f(\kappa)}{\Gamma_H(\kappa, B_{\text{inv.}}, B_{\text{u.}})}$$

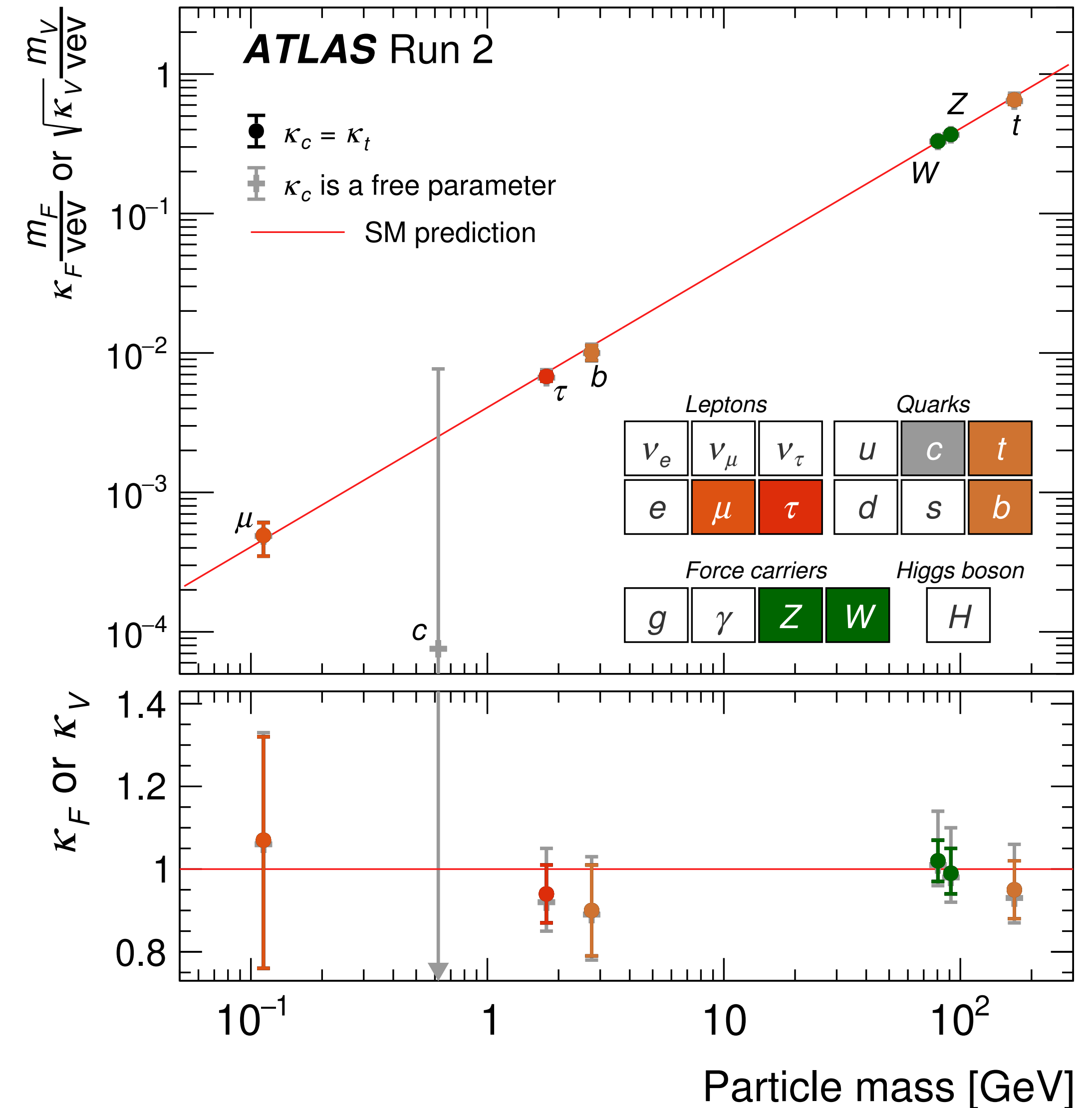

Higgs-production cross section

arXiv:2207.08615

Total and differential Higgs-boson production

- combining fully-resolved high-resolution channels $H \rightarrow ZZ^* \rightarrow 4\ell$ and $H \rightarrow \gamma\gamma$
- $\sigma_{\text{tot}} = 55.5 \pm 3.2$ (stat.) ± 2.3 (syst.) pb (SM: 55.6 ± 2.8 pb)
- including Higgs p_T , $|y|$; jet: #jets, #b-jets, p_T (jet1); VBF: m_{jj} , $|\Delta\eta_{jj}|$, $\Delta\phi_{jj}$

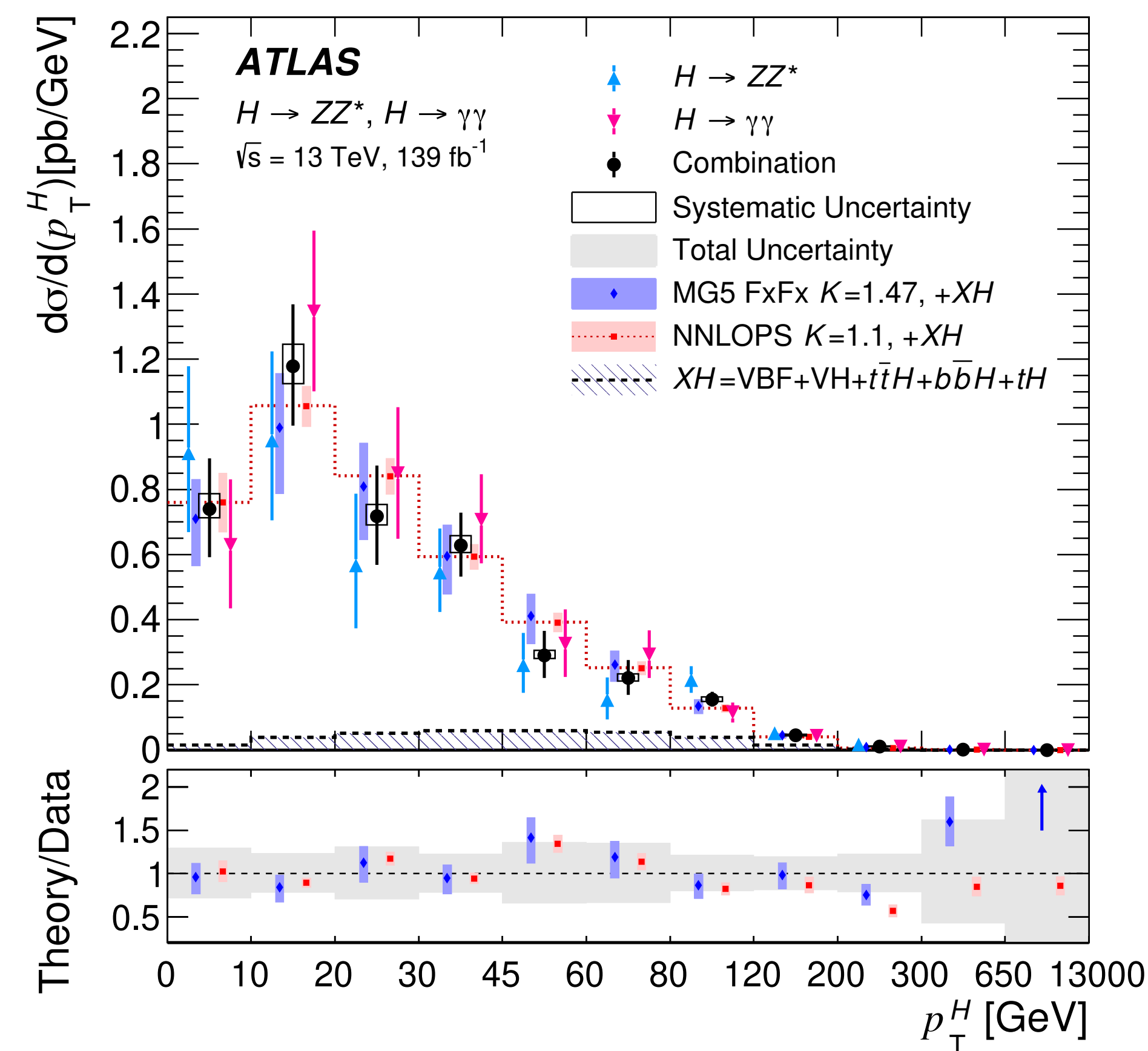
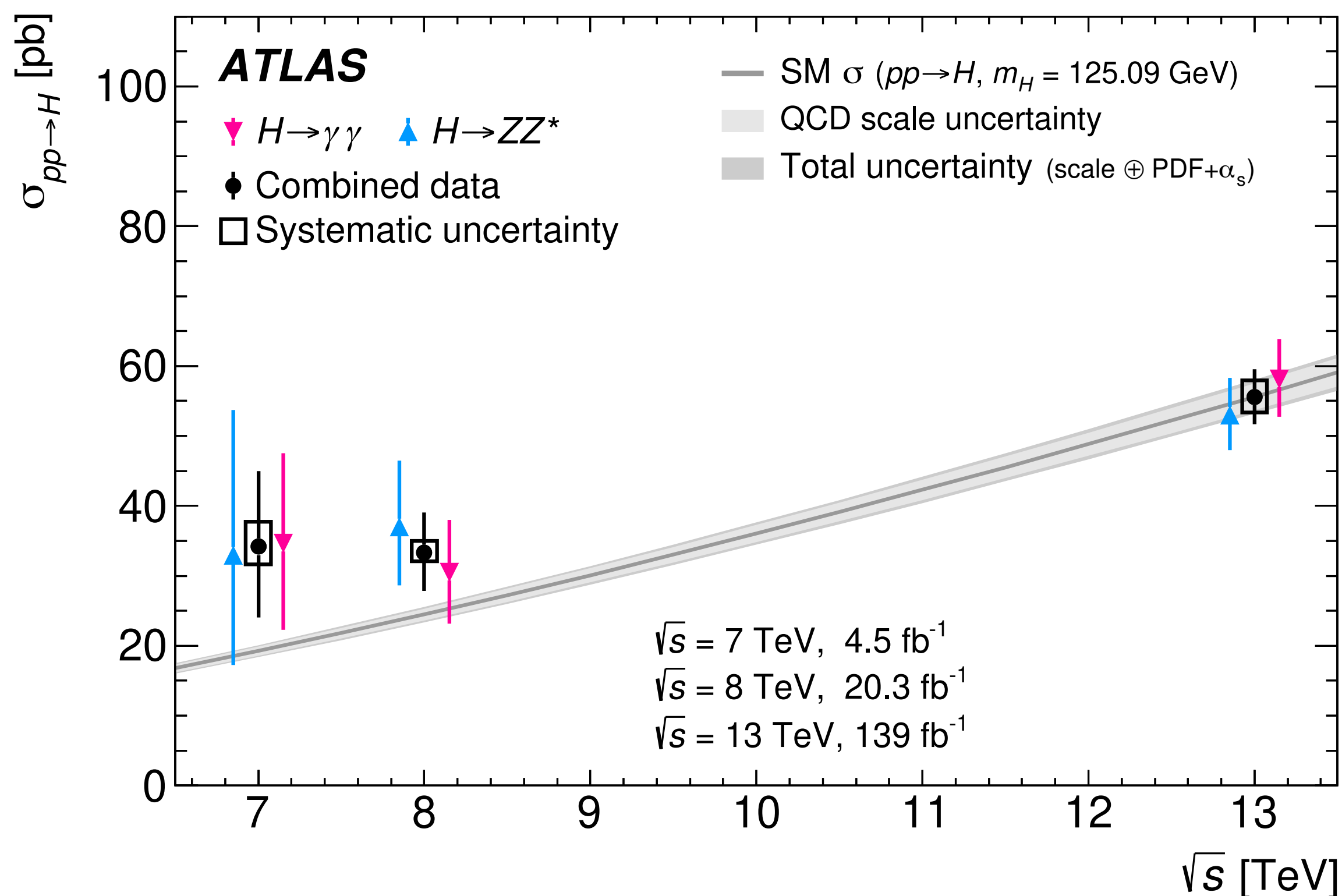

Higgs-boson mass for $H \rightarrow ZZ^* \rightarrow 4\ell$

arXiv:2207.00320

Simultaneous fit to all channels

- most precise measurement by ATLAS so far; systematic uncertainty of 40 MeV

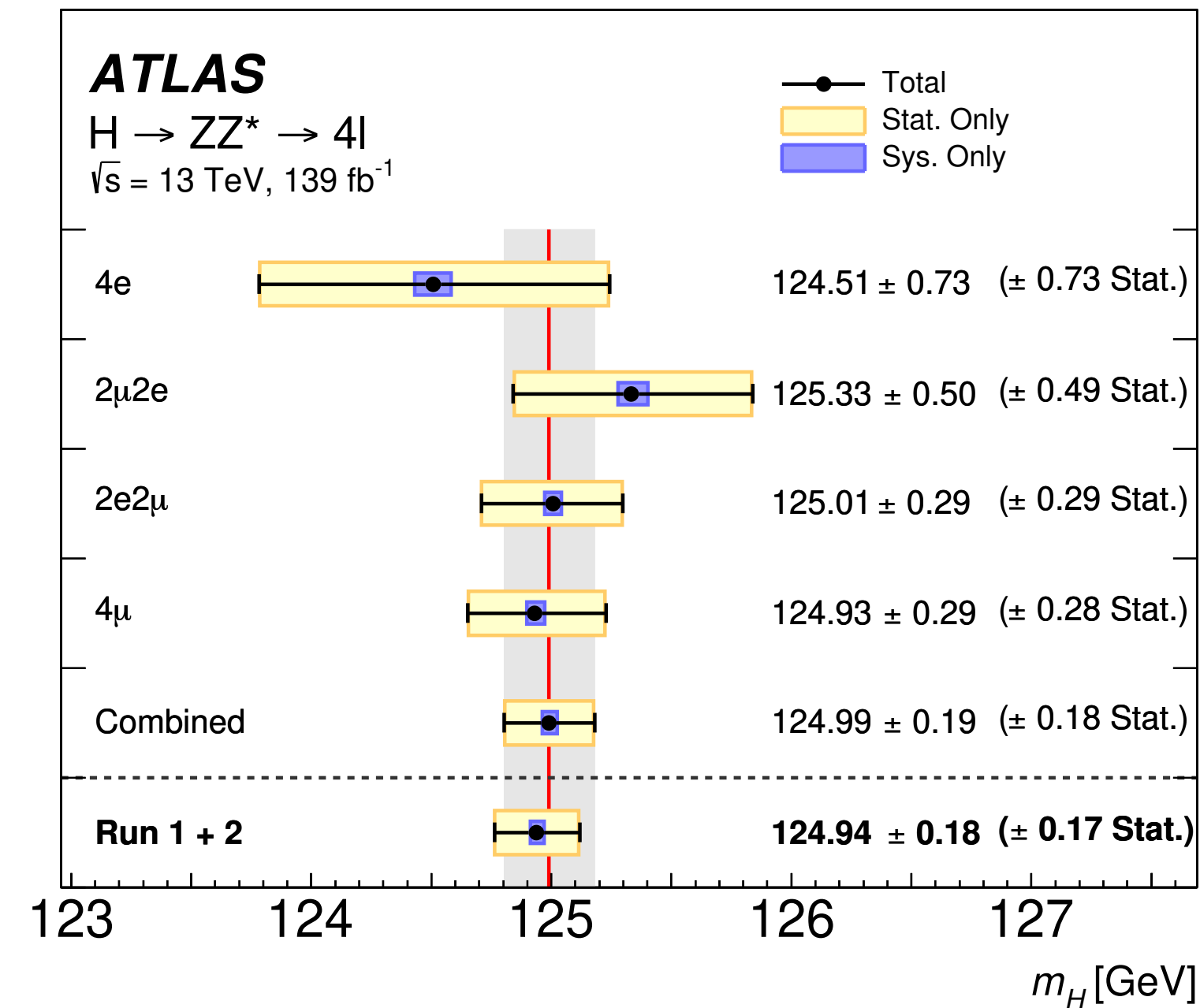
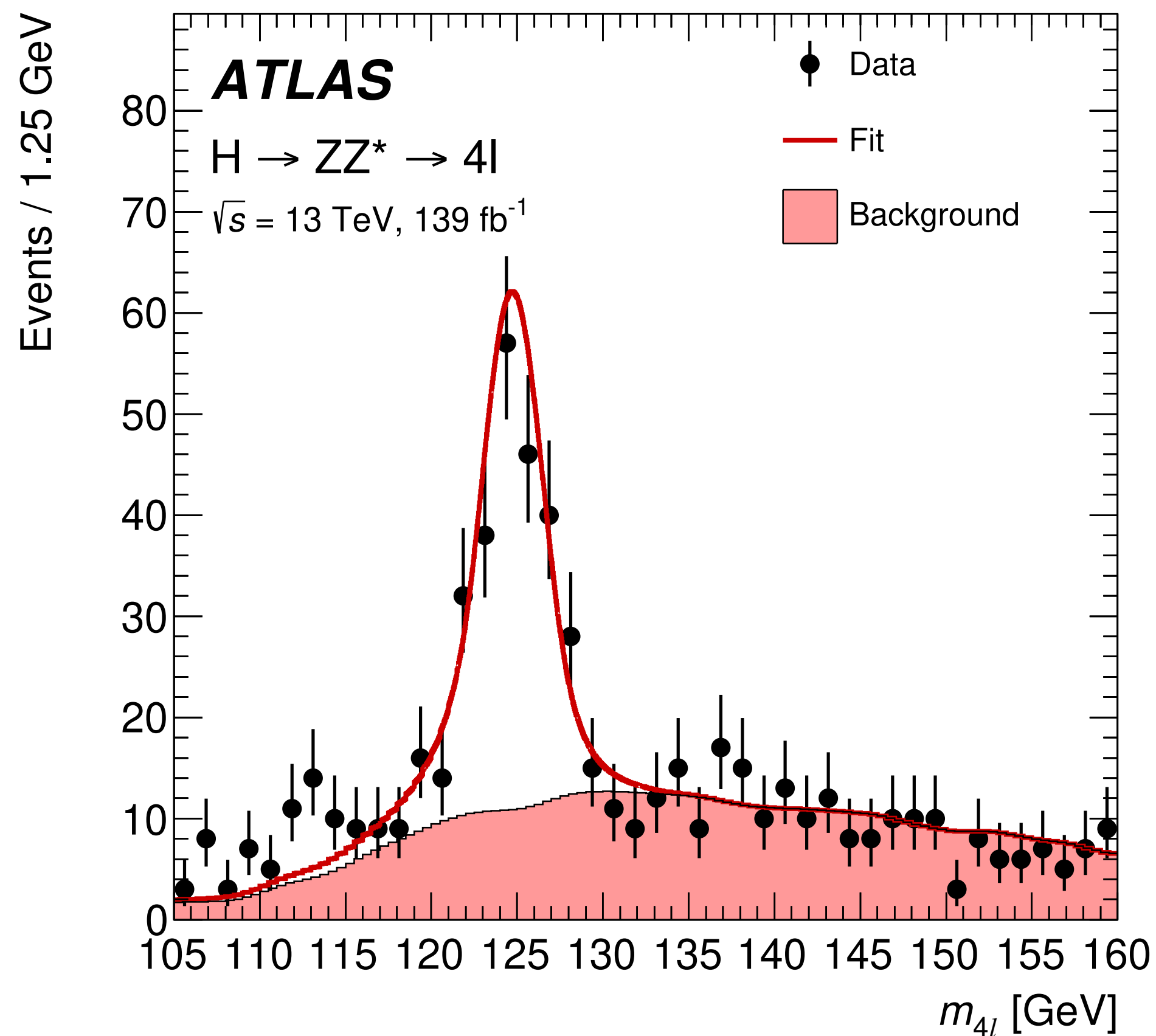

**1.4 per mil
precision**

Systematic Uncertainty	Contribution [MeV]
Muon momentum scale	±28
Electron energy scale	±19
Signal-process theory	±14

CP structure in the Higgs sector

Run-1 data identified H as a CP-even scalar

- room for CP-odd admixtures – potential for CP violation

How to look for signs of CP violation in Higgs couplings?

- modified rates – not immediately distinguishable from CP-even BSM
- characteristic: interference effects on shapes of CP-odd observables
→ can extract limits from rate measurements, but dedicated CPV searches typically use shape information

Fermion couplings

- CP-odd contribution allowed at **tree level**
- Mainly third-generation couplings
- ttH production and $H \rightarrow \tau\tau$ decays

Example model: $\mathcal{L}_{HFF} \propto \kappa_F (\underbrace{\cos \phi \bar{F}F}_{\text{even}} + \underbrace{\sin \phi \bar{F}i\gamma_5 F}_{\text{odd}})H$

Boson couplings

- CP-odd contribution from higher order operators - **suppressed** by BSM scale
- VBF/VH production and WW/ZZ decays

Example model: $\mathcal{L}_{HVV} \supset \mathcal{L}_{HVV,SM} + \frac{1}{\Lambda^2} c \underbrace{H\tilde{V}_{\mu\nu}V^{\mu\nu}}_{\substack{\text{dim-6} \\ \text{CP-odd}}} + \dots$

frequently:
embedded in
EFT framework

Tests CP properties of the τ Yukawa

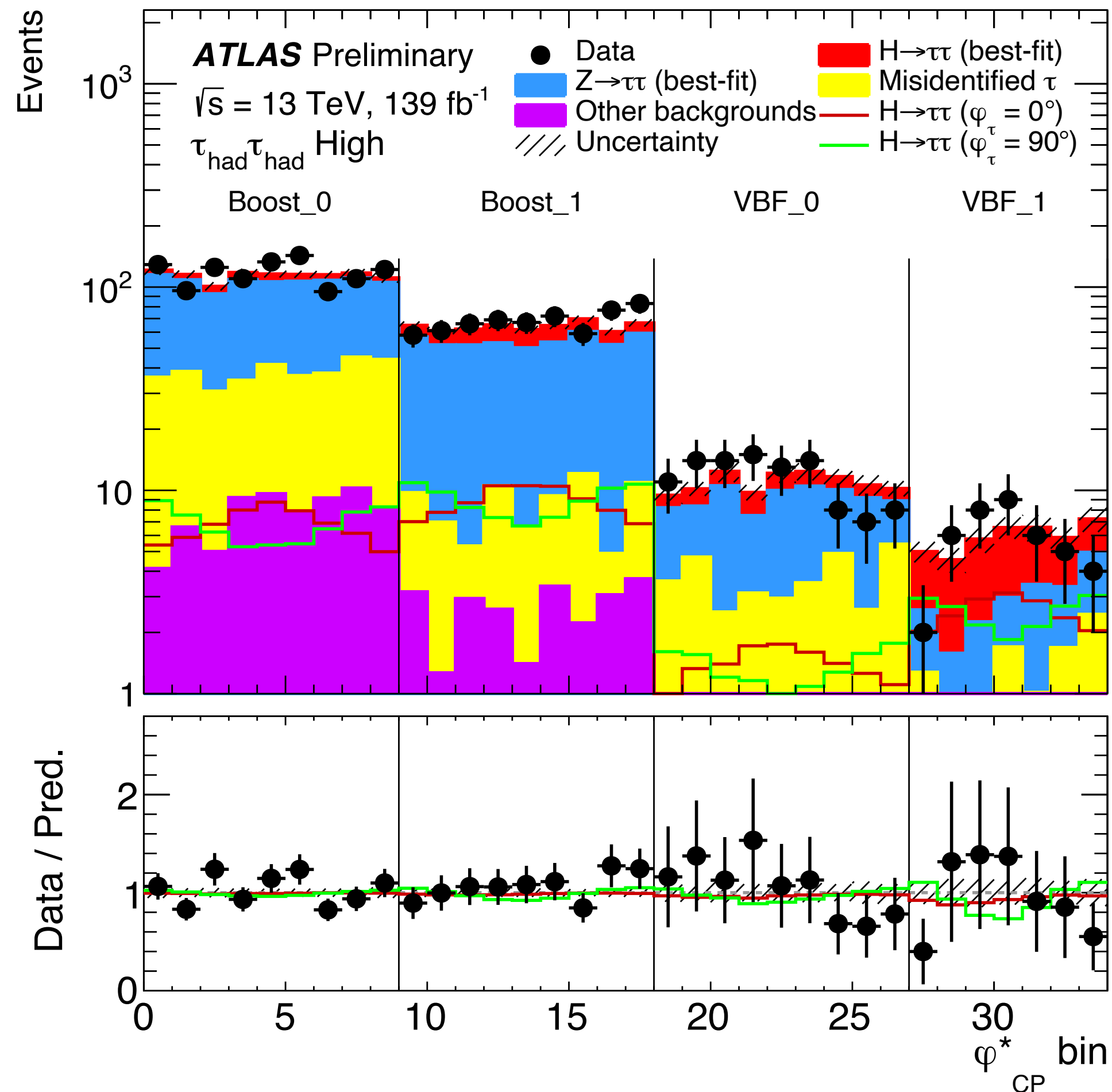

First ATLAS analysis to use tau decay classification

CP mixing angle ϕ_τ is reflected in decay kinematics

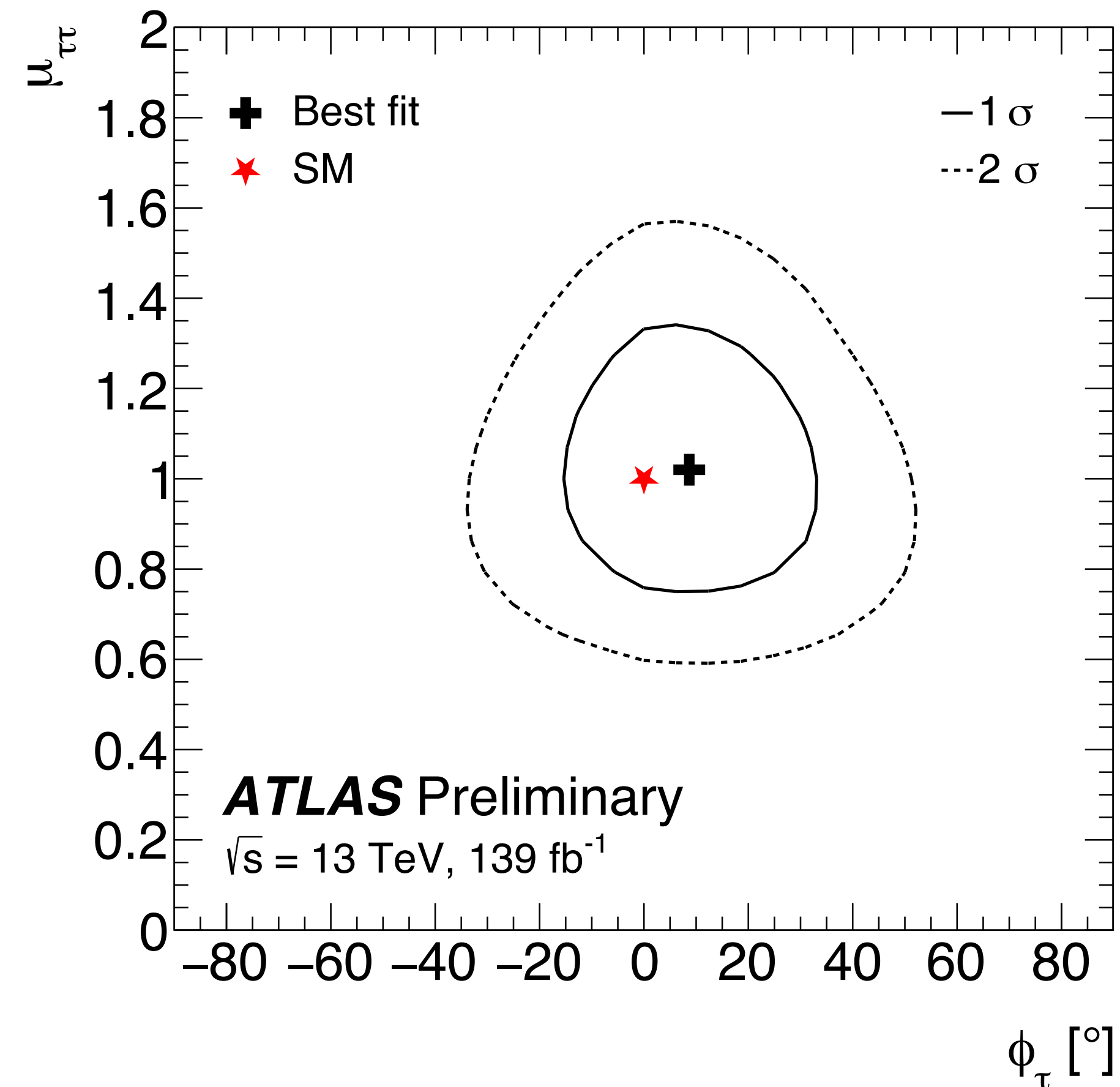

Reject the CP odd hypothesis at 3.4σ (2.1σ exp.)

Further Higgs CP measurements

Fermionic coupling: $t\bar{t}H$ with $H \rightarrow b\bar{b}$

- form top candidates from jets & leptons to define CP-sensitive observables
- evaluated in several SR, exploiting (b)-jet multiplicity and dedicated BDT classifiers
- challenge: modelling of large $t\bar{t}+b$ background
- pure CP-odd disfavoured at 1.2σ level

[ATLAS-CONF-2022-016](#)

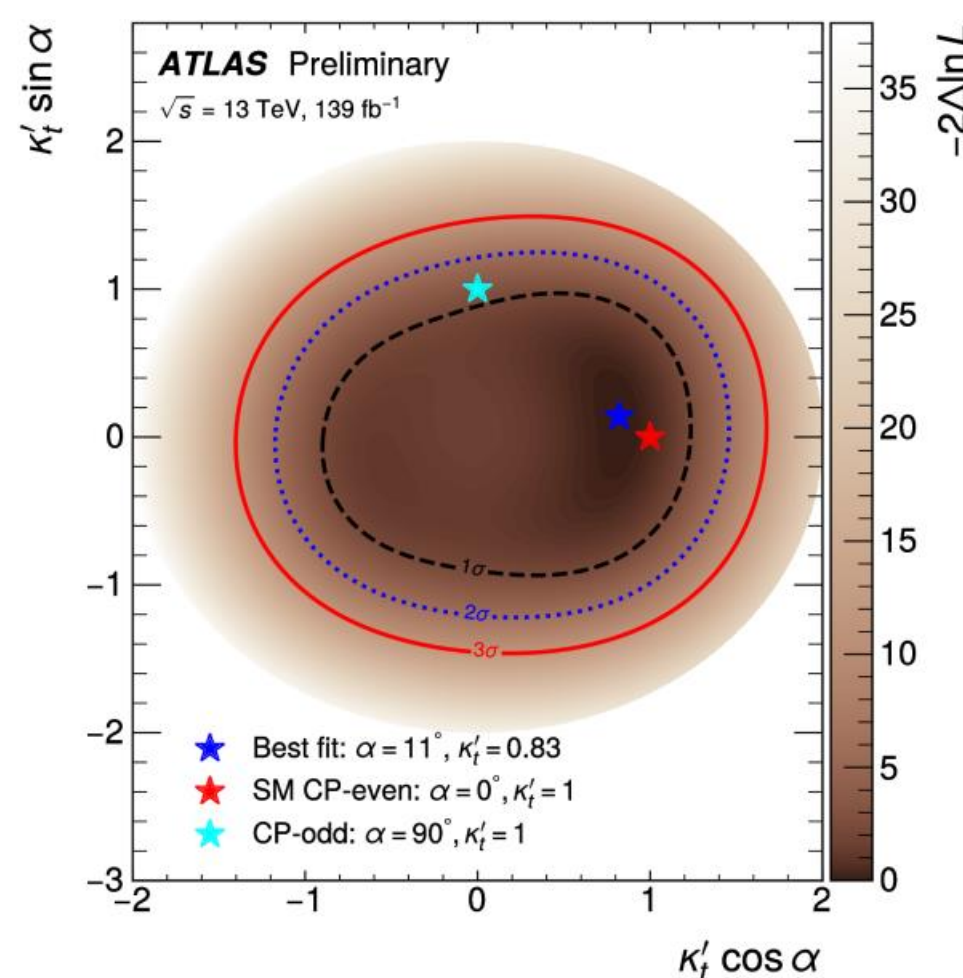
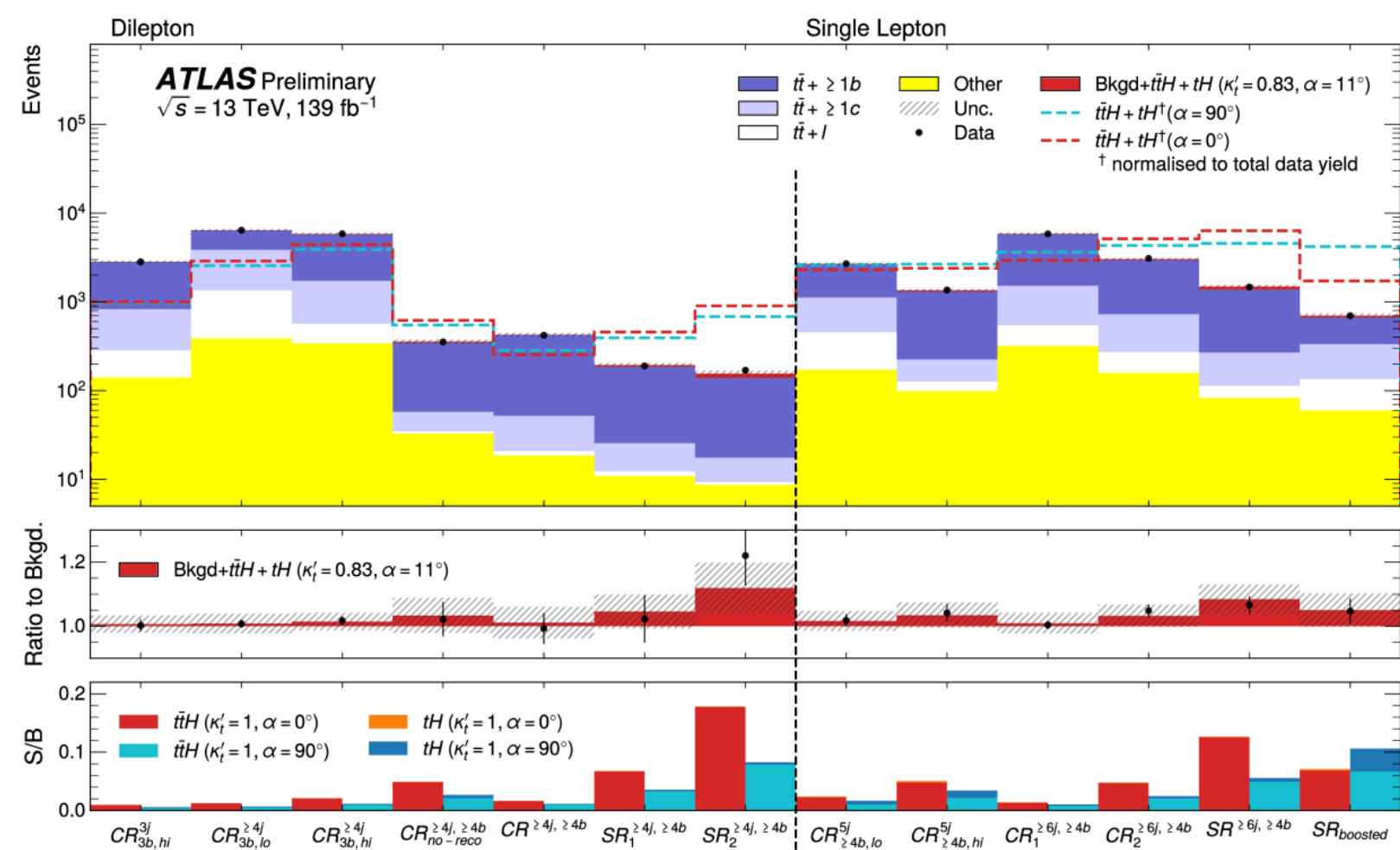

Bosonic coupling: VBF $H \rightarrow \gamma\gamma$

- exploit properties of dijet system
- optimal observable (M.E. discriminant)
- direct measure of interference impact
- pure shape analysis – signal rates floating
- result compatible with SM expectation

[arXiv:2208.02338](#)

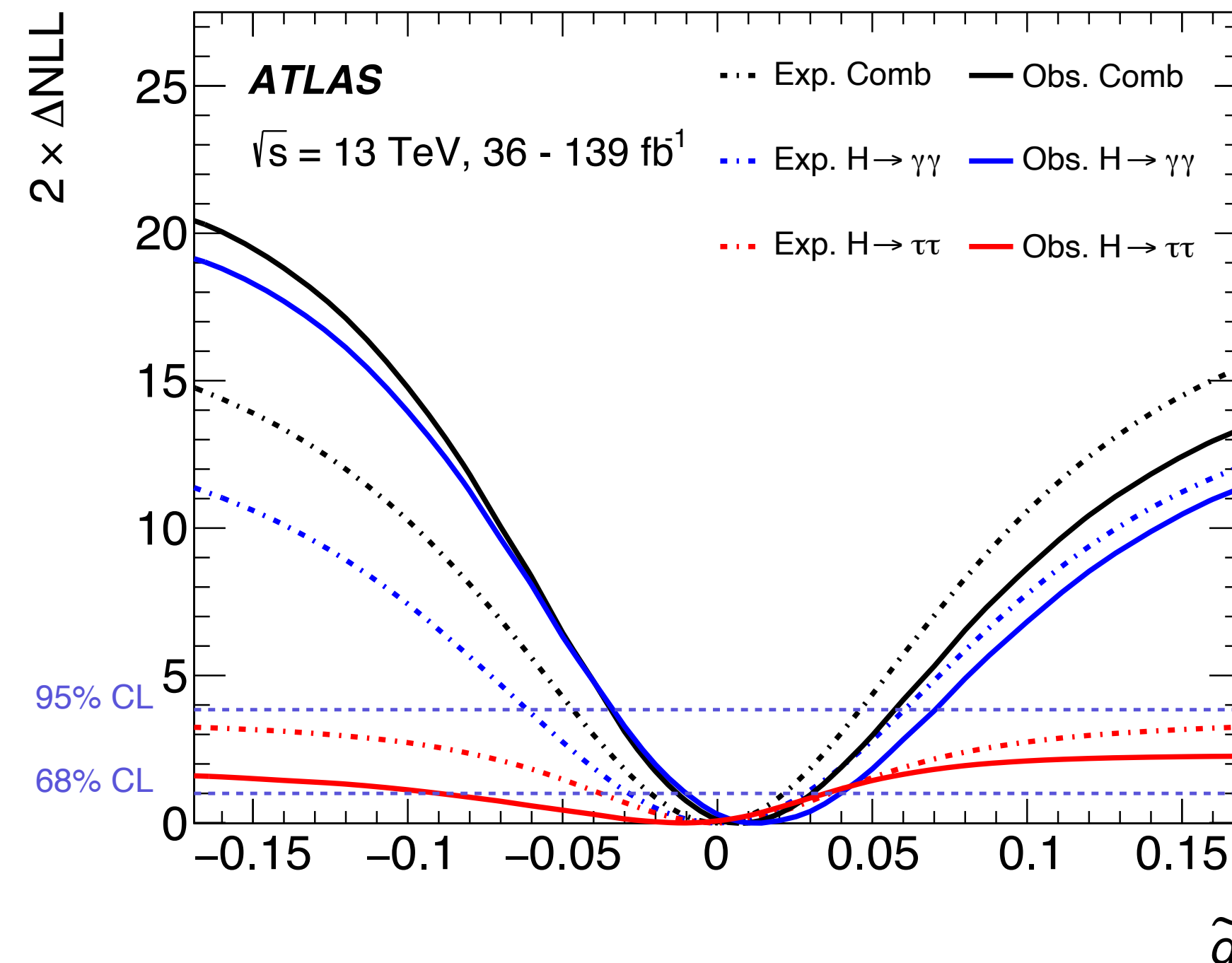

Searching for Higgs pair production

Probe Higgs self-interaction and Higgs potential

- main challenges
 - very small cross section 32.7 fb ($< 1/1000$ of single H)
 - negative interference between main contributions
- compromise between stats. and S/B:
 - $(H \rightarrow b\bar{b}) \times (H \rightarrow \gamma\gamma, \tau\tau, b\bar{b})$
- sensitivity with full Run-2 data set significantly improved over partial Run-2 results

ATLAS-CONF-2022-050

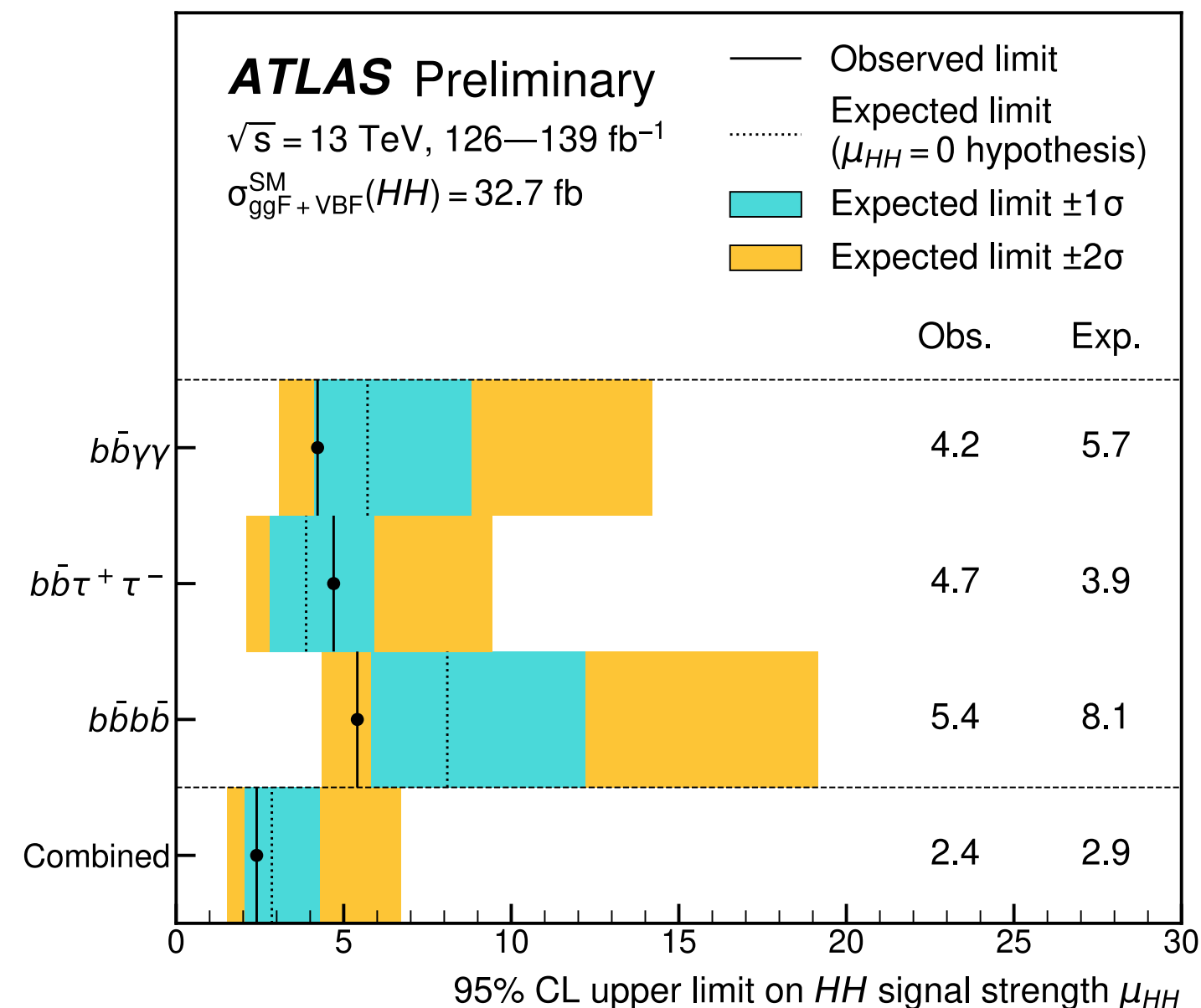
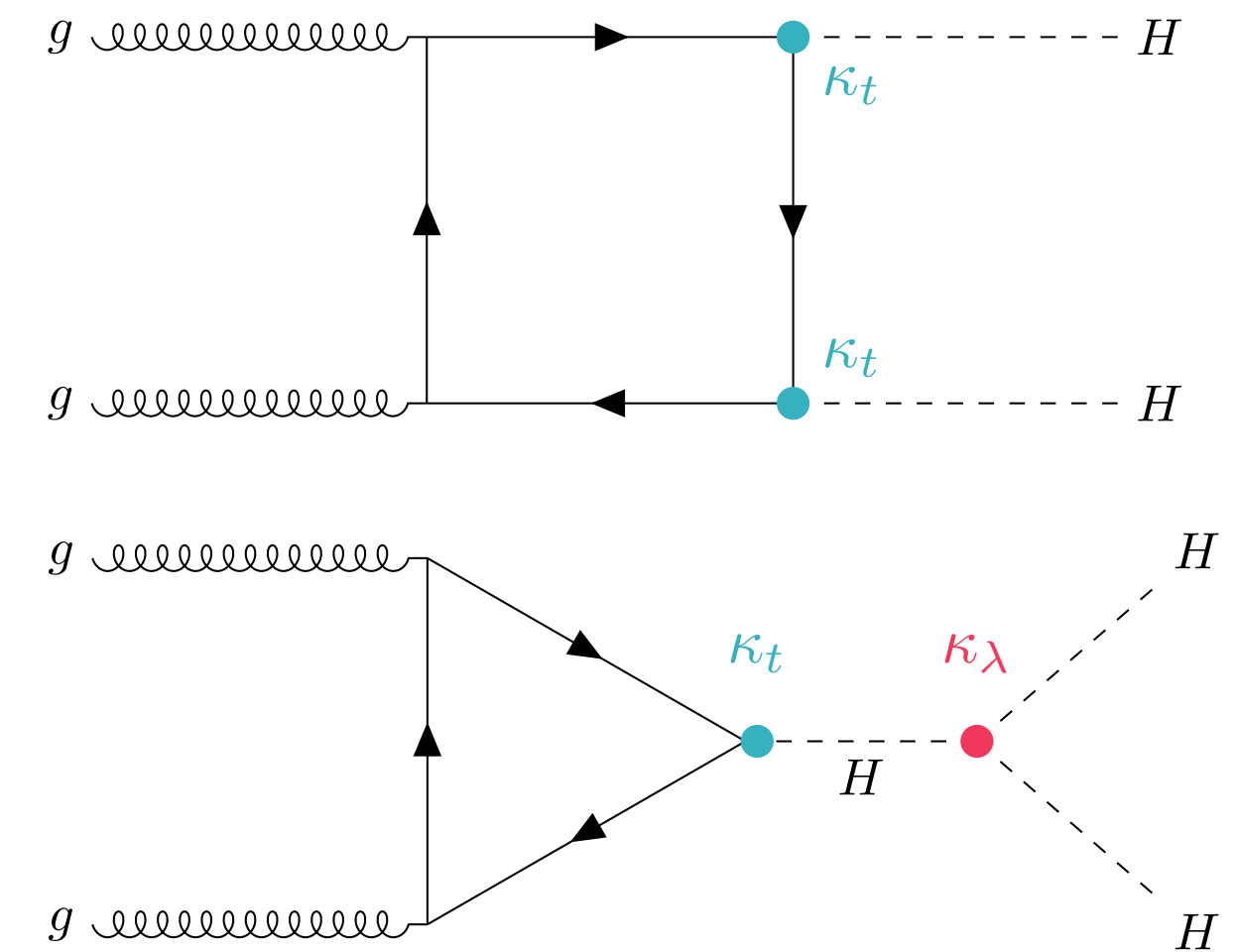

Searching for Higgs pair production

Probe Higgs self-interaction and Higgs potential

- main challenges
 - very small cross section 32.7 fb ($< 1/1000$ of single H)
 - negative interference between main contributions
- compromise between stats. and S/B:
 - $(H \rightarrow b\bar{b}) \times (H \rightarrow \gamma\gamma, \tau\tau, b\bar{b})$
- sensitivity with full Run-2 data set significantly improved over partial Run-2 results

ATLAS-CONF-2022-050

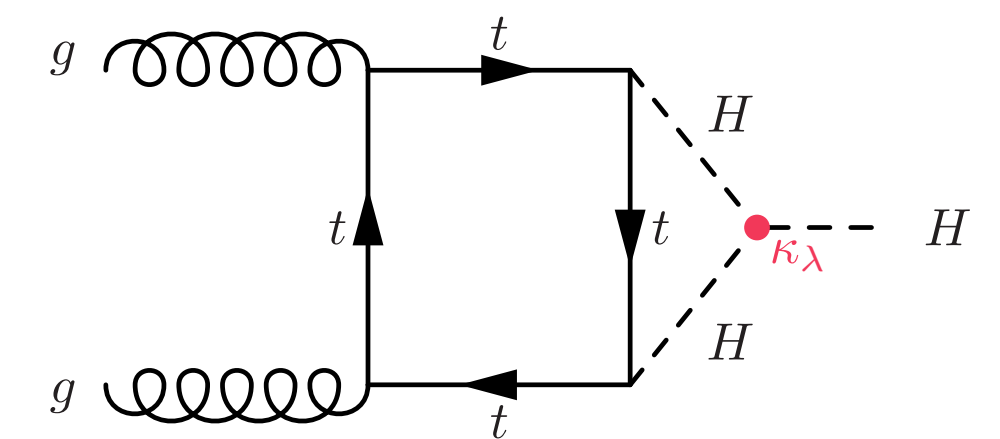
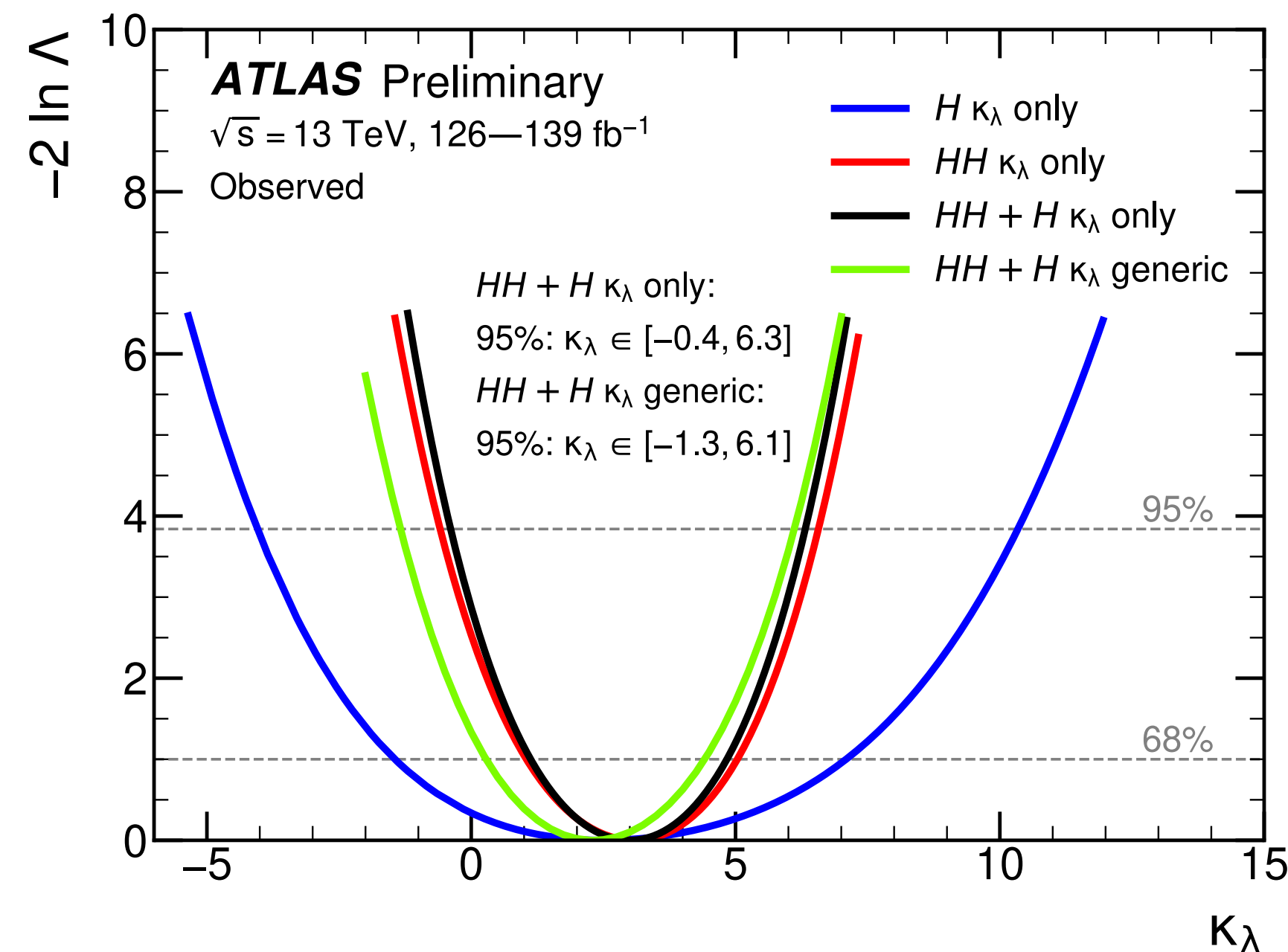
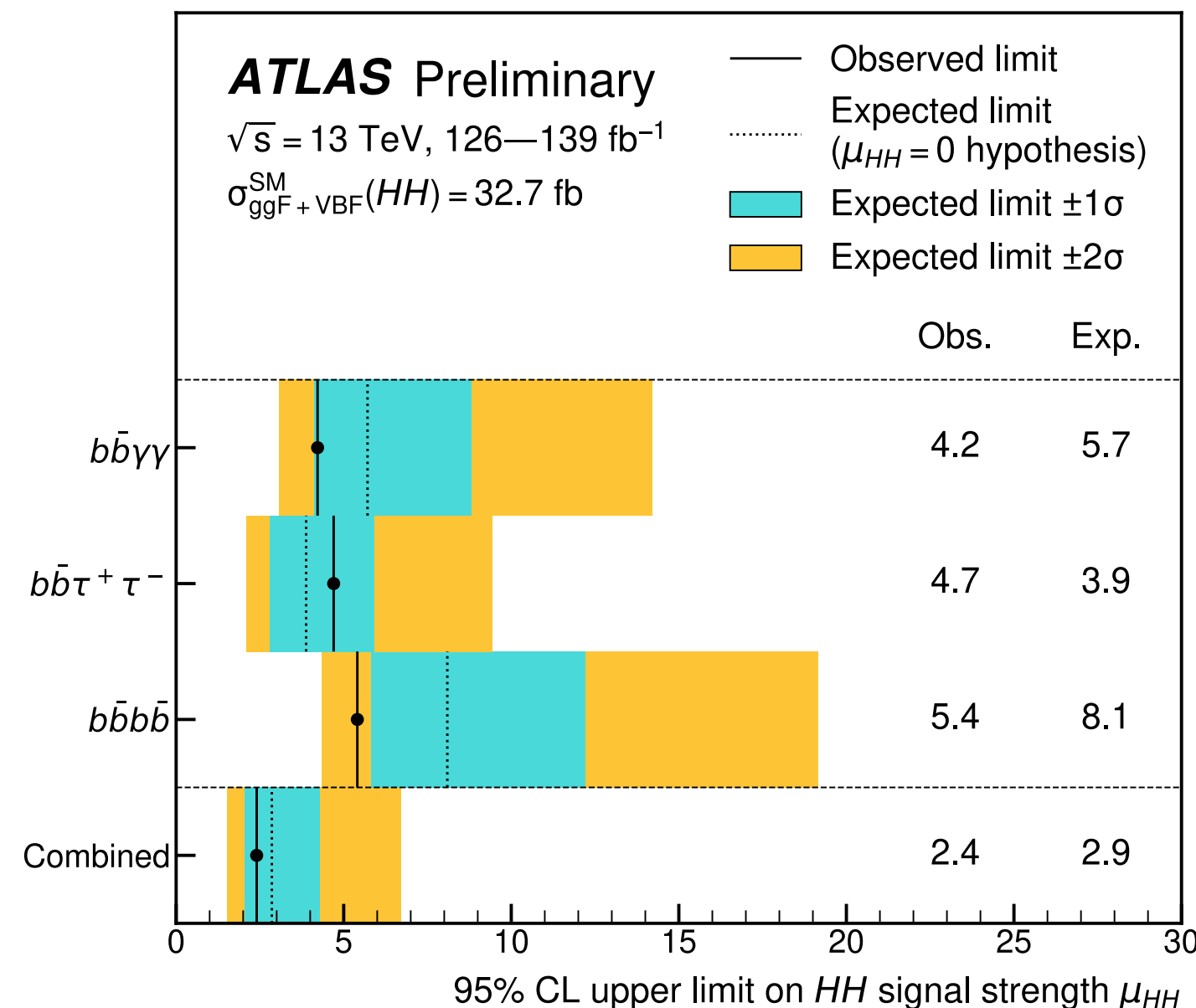
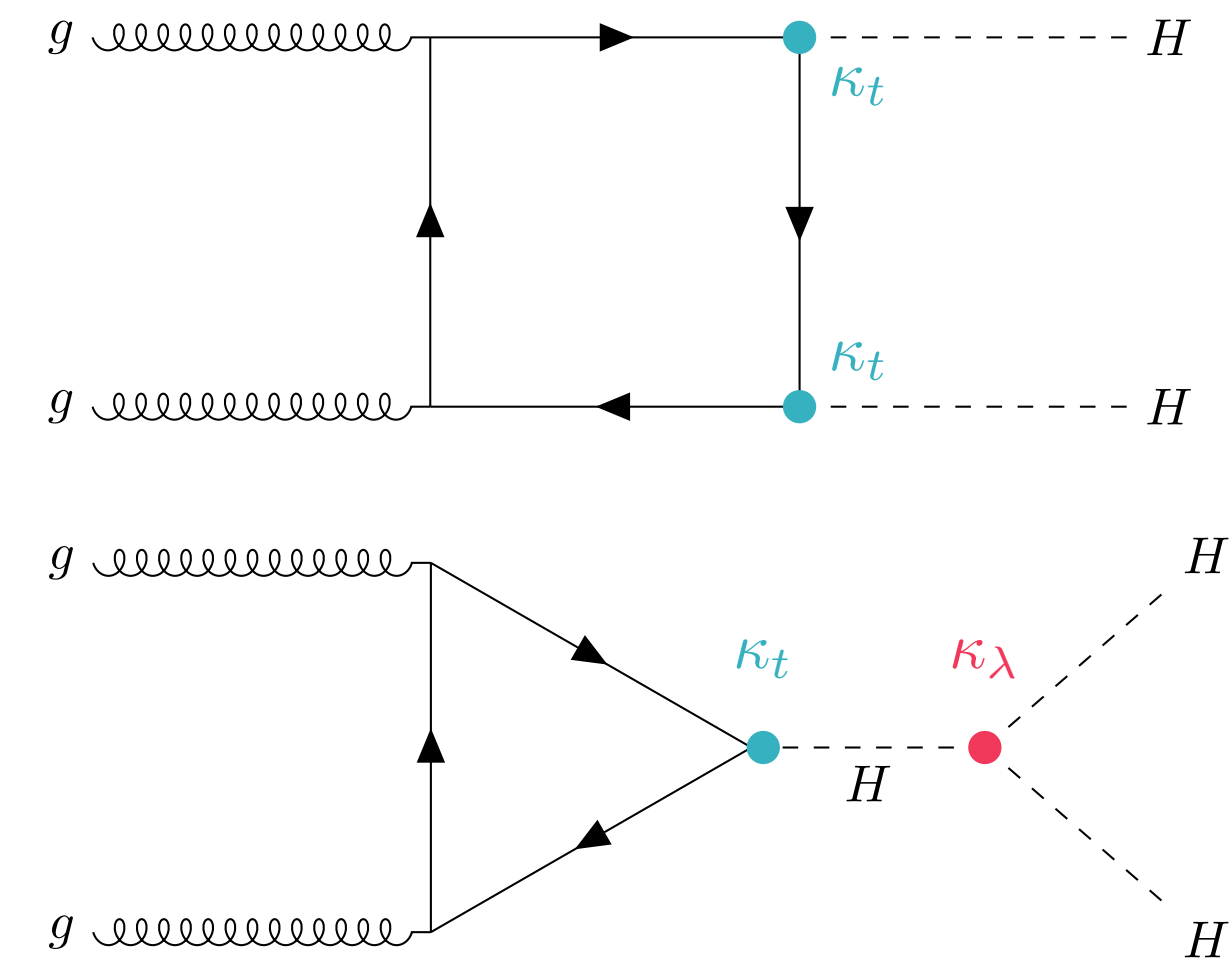

Searches for extended scalar sector

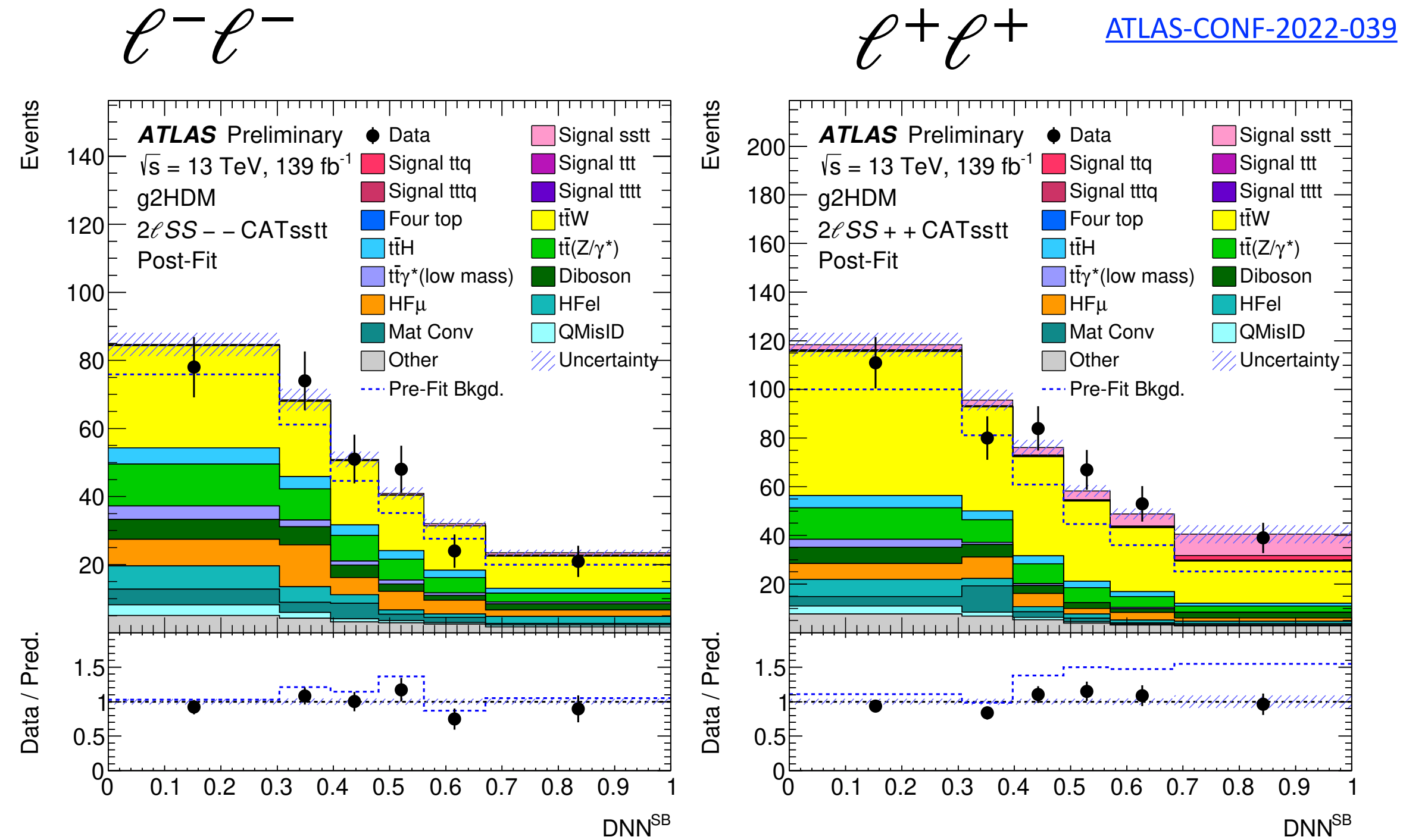
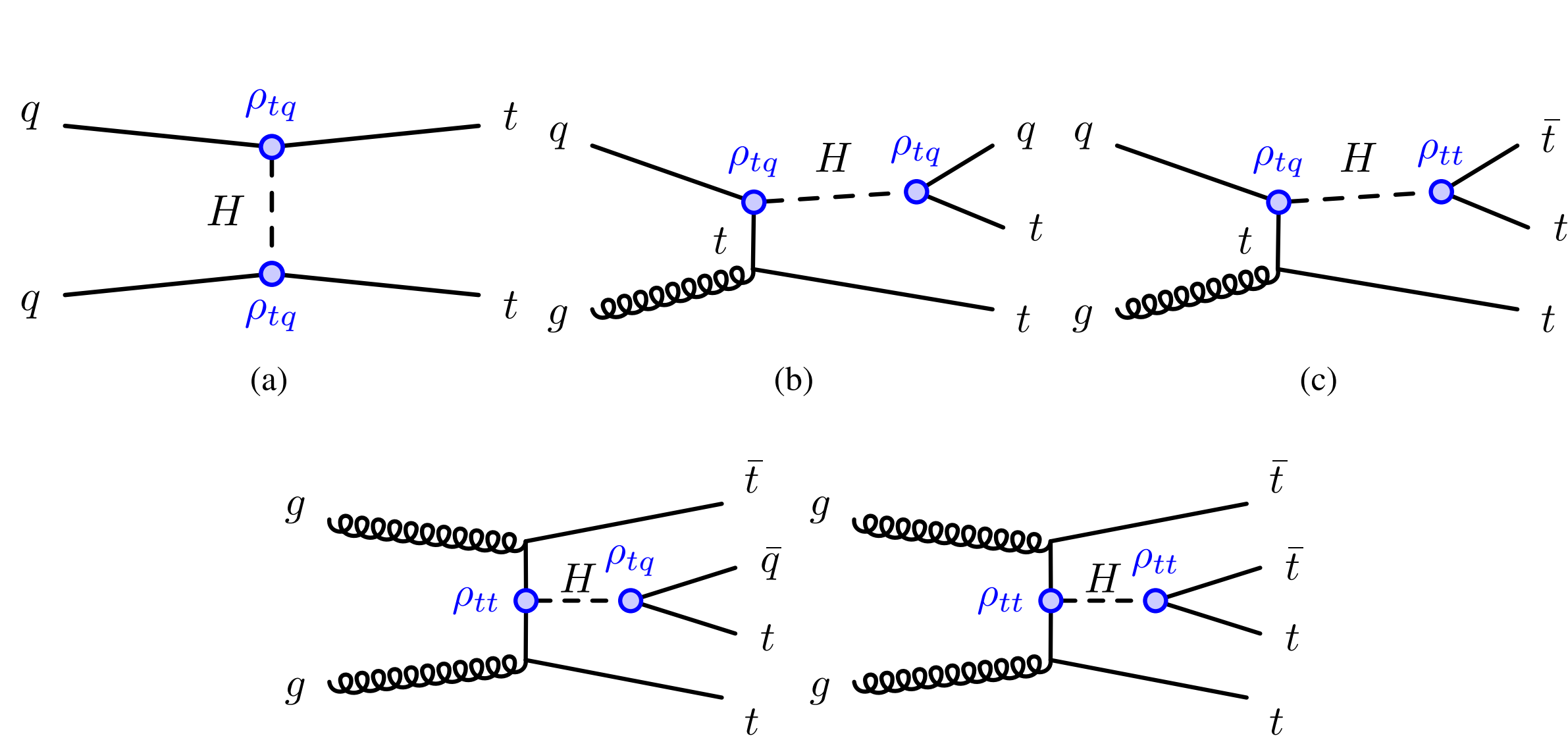

Motivated in many BSM models

- benchmark 2 Higgs doublet model \rightarrow 5 states
- one identified with $h(125)$ and quasi SM like

Generic 2HDM model

- scan $\rho_{tt}, \rho_{tc}, \rho_{tu}$ couplings for heavy Higgs masses 200–10000 GeV

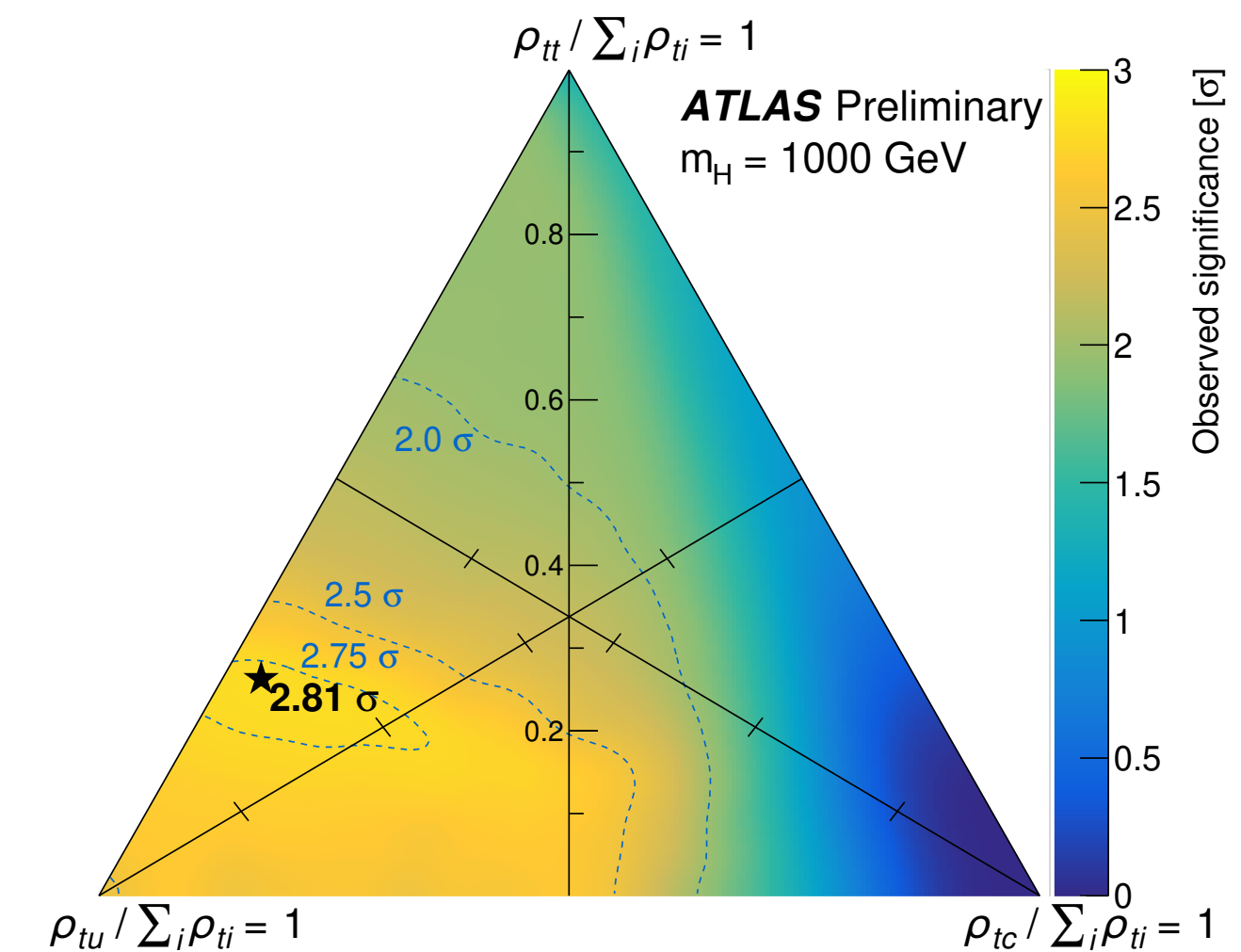

Search for $Y \rightarrow XH$

ATLAS-CONF-2022-045

- fully hadronic final state
- high mass Y and boosted X and H
- anomaly detection search + exclusion limits with “standard” selection
- merged and resolved categories for X

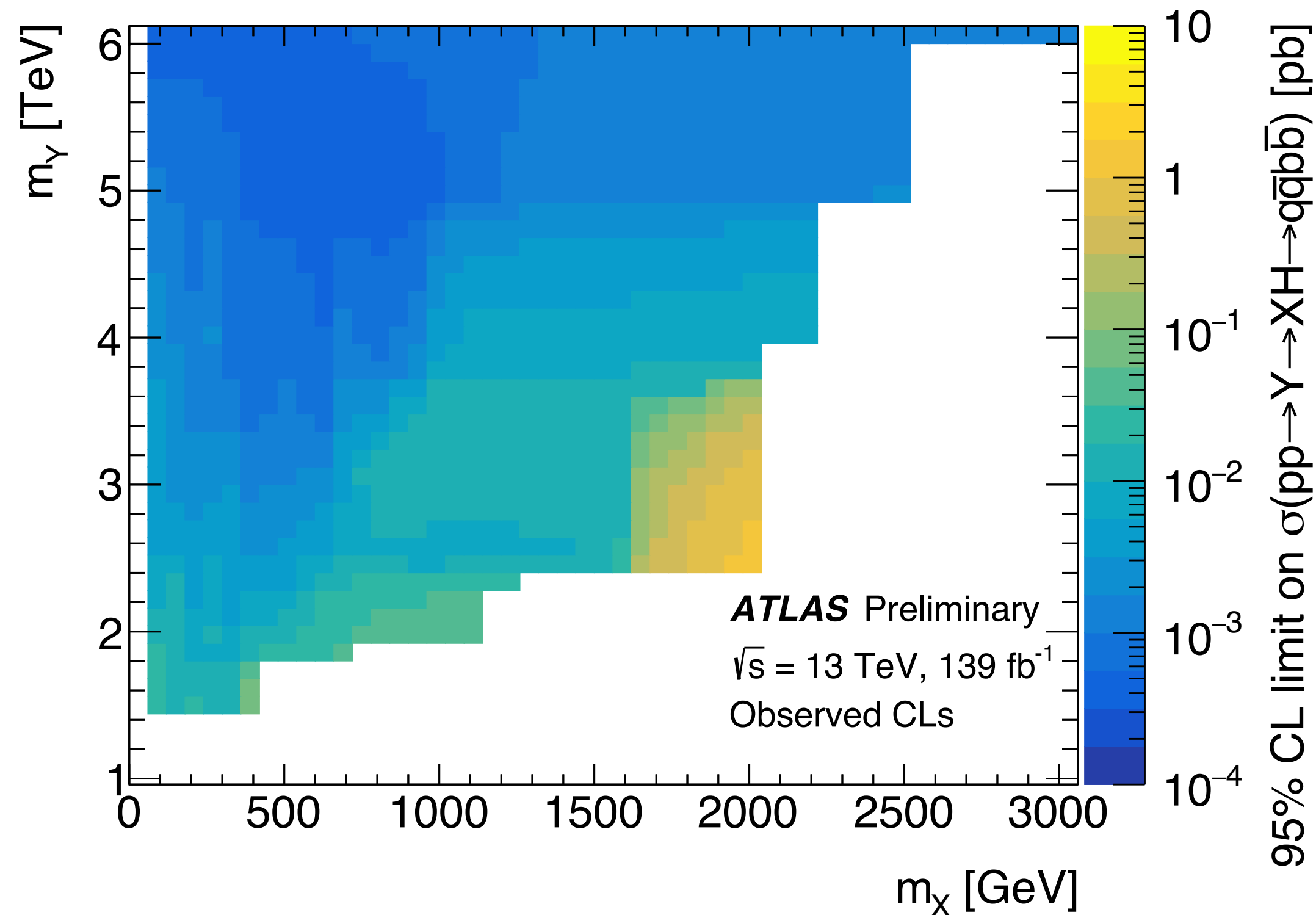
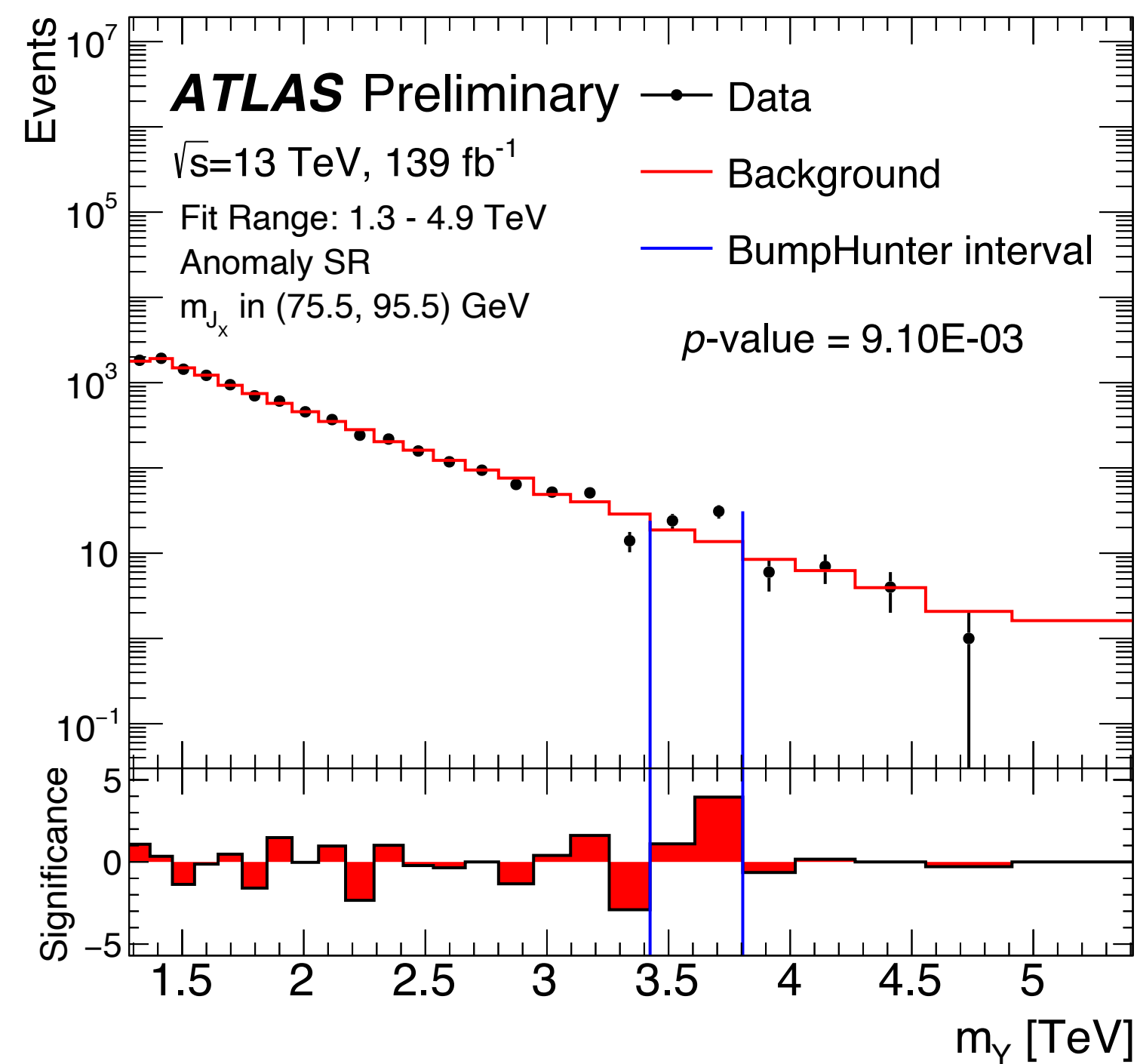
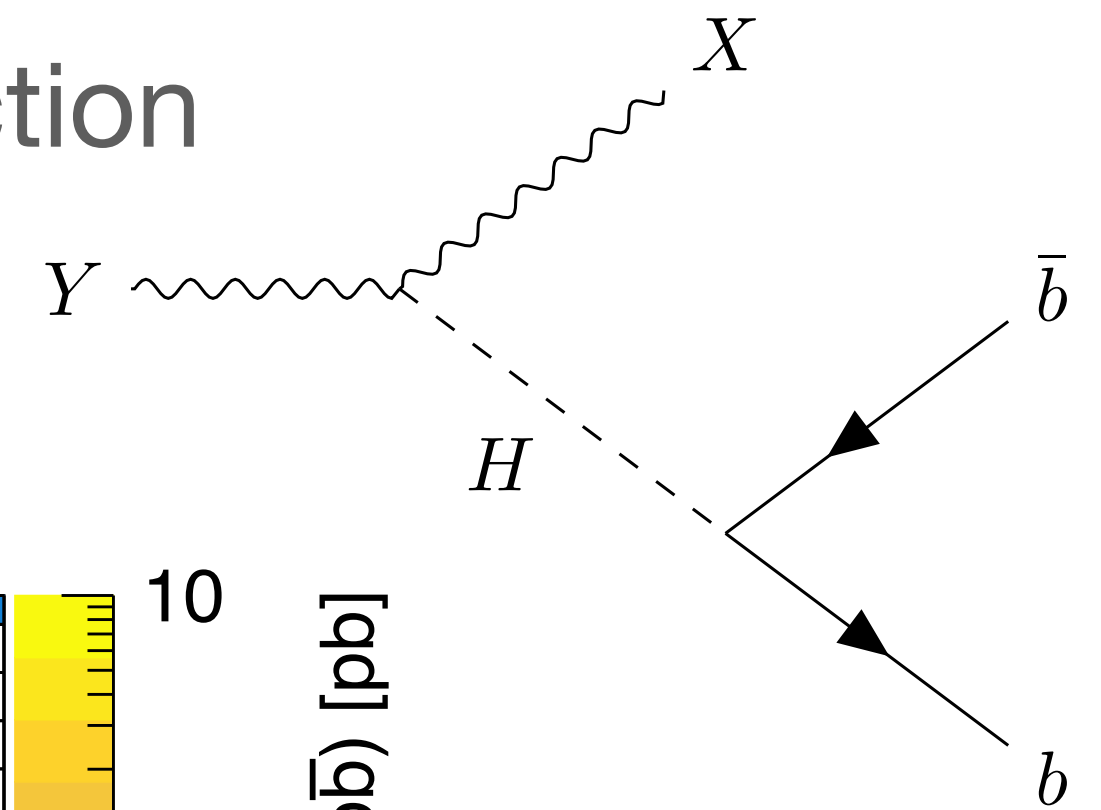

Searches motivated by Dark Matter

arXiv:2202.07953

Search for $H \rightarrow$ Dark matter (invisible)

- BR ($H \rightarrow$ invisible) < 14.5% (obs), 10.3% (exp) from search with VBF topology (95% C.L.)

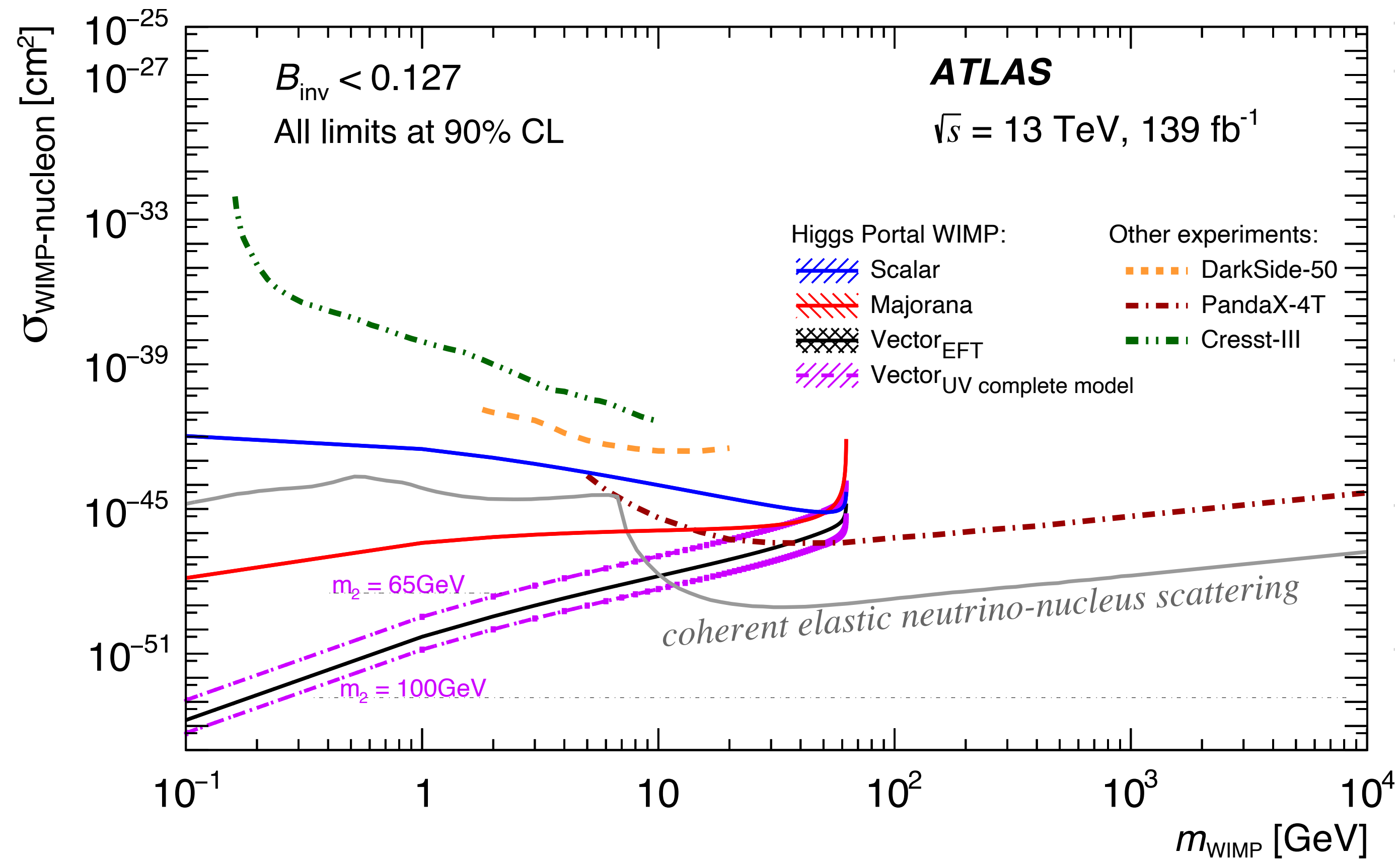
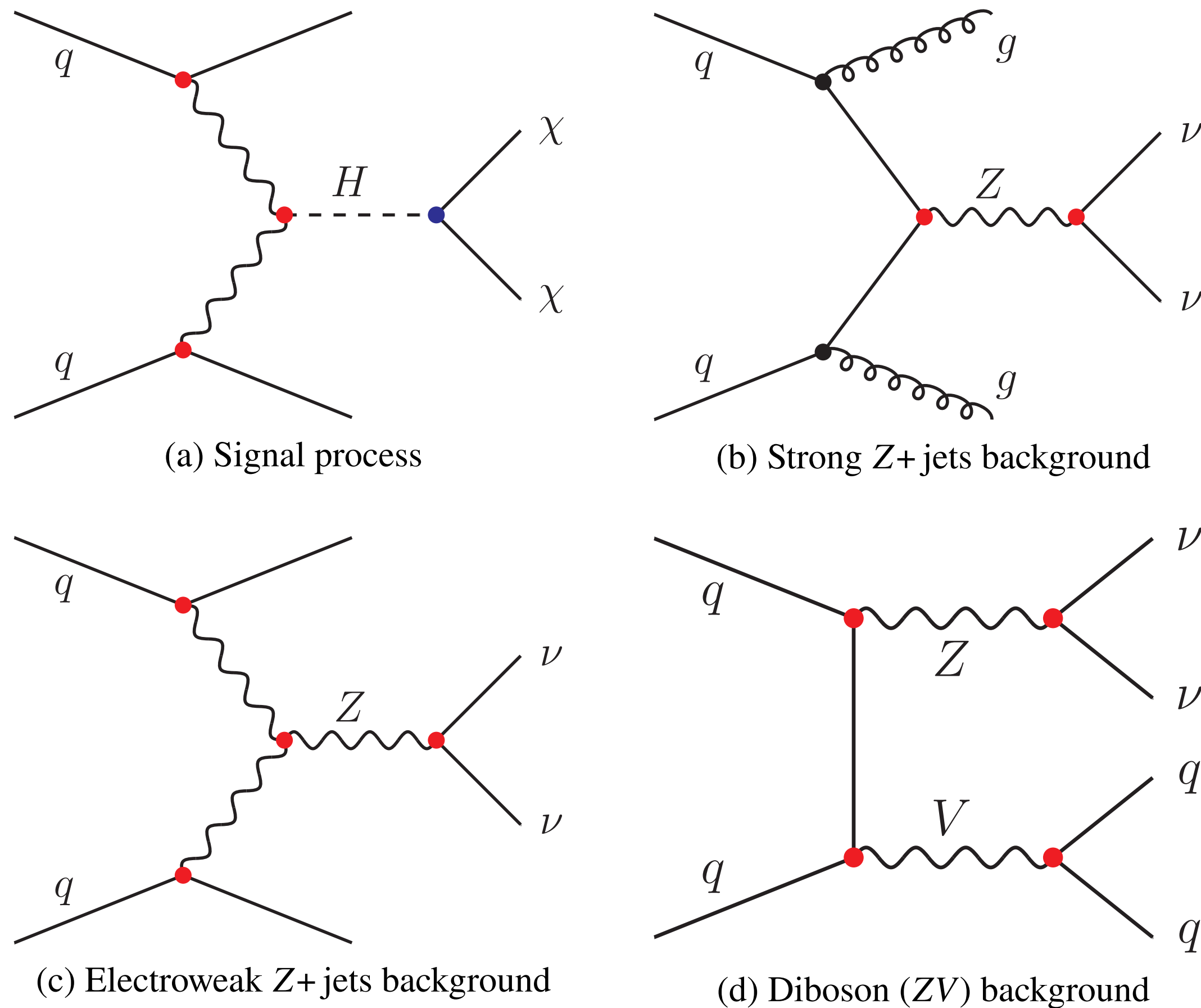

Searches motivated by Dark Matter

ATLAS-CONF-2022-036

Part of wide mono- X searches + E_T^{miss} (here $X=\text{top}$)

- fully hadronic boosted final state
- mass reach for V mediator ~ 2.5 TeV
- probe also non-resonant model
- large increase of sensitivity wrt previous analysis
- most restrictive limit on single production of a singlet VLQ

Production in non-resonant and resonant case

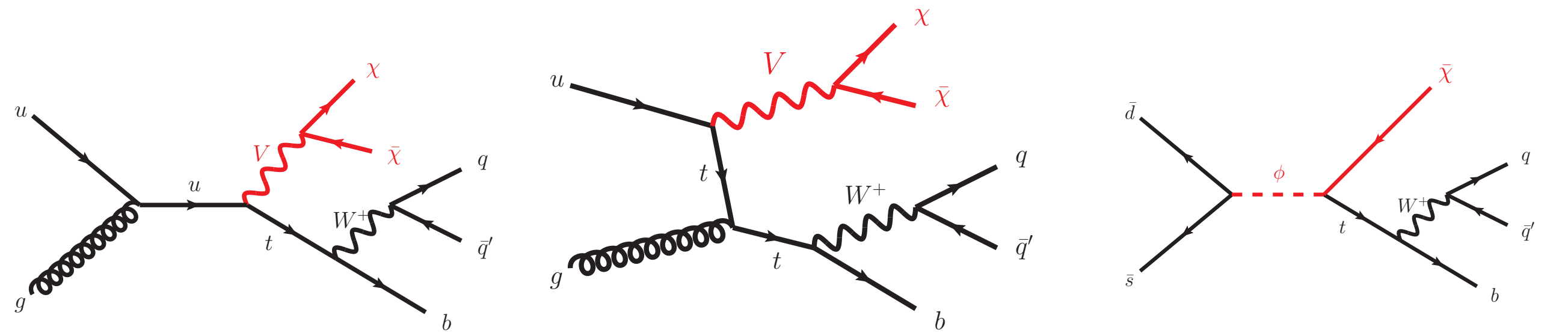

Production of a single vector-like top quark

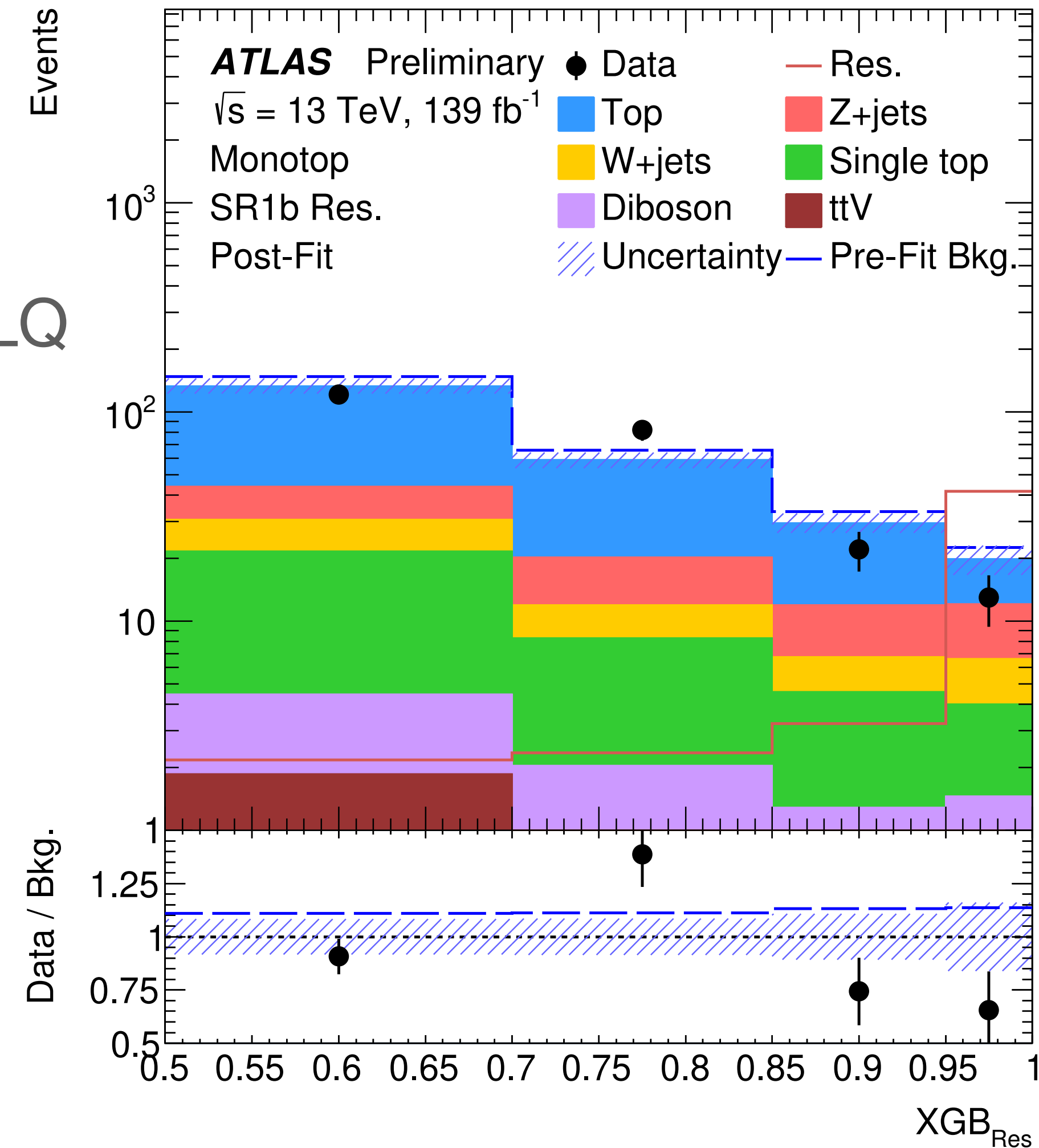
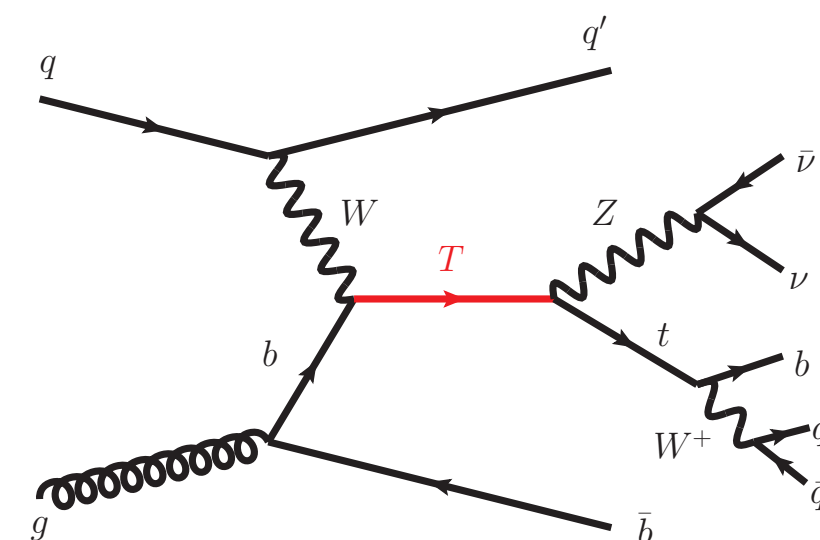

Searches motivated by Dark Matter

ATLAS-CONF-2022-038

Search for non-resonant production of semi-visible jets

- strong dark sector
- use E_T^{miss} , H_T , p_T^{bal} and $\Delta\phi$
- reach ~ 2.5 TeV (dep. on coupling)

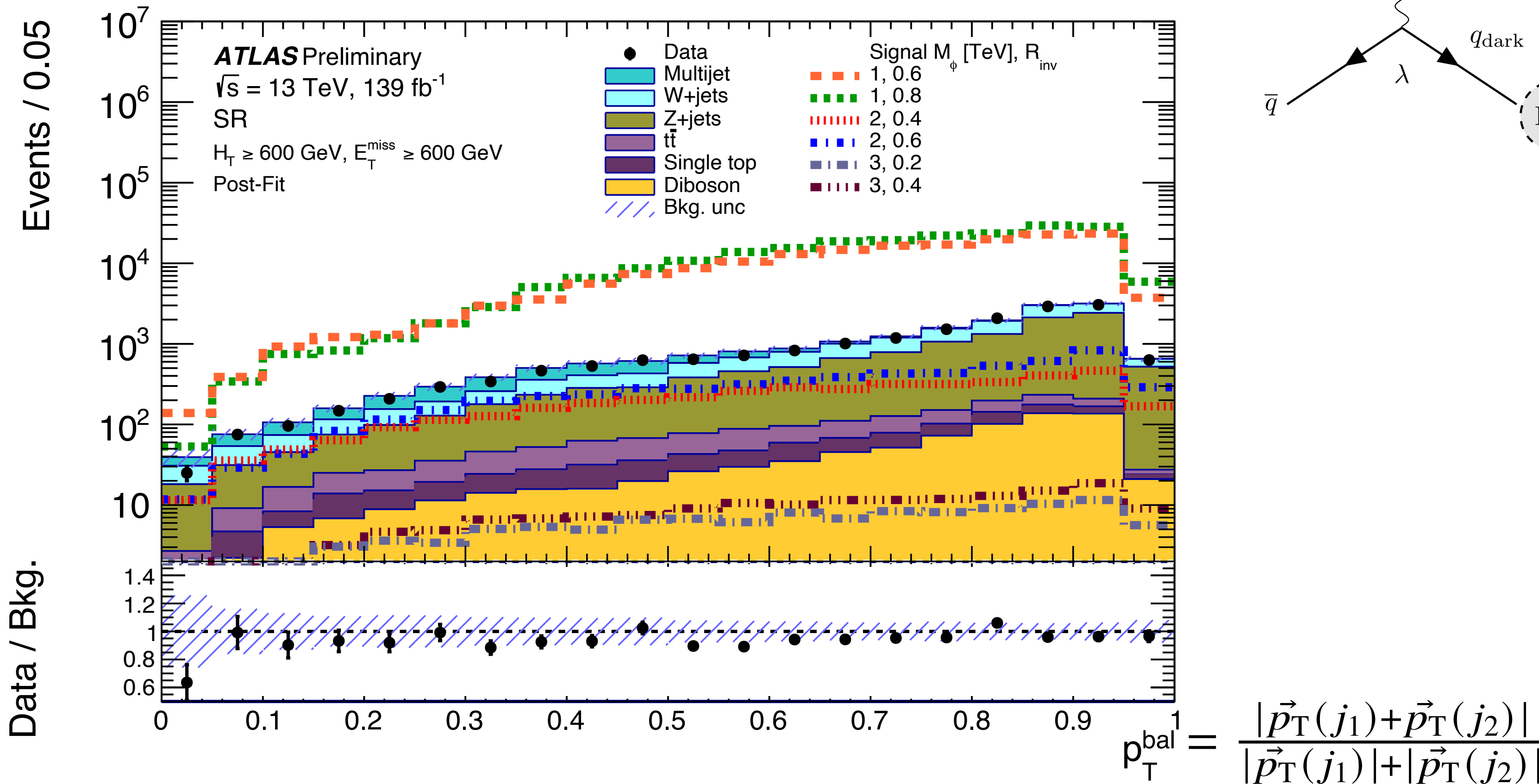
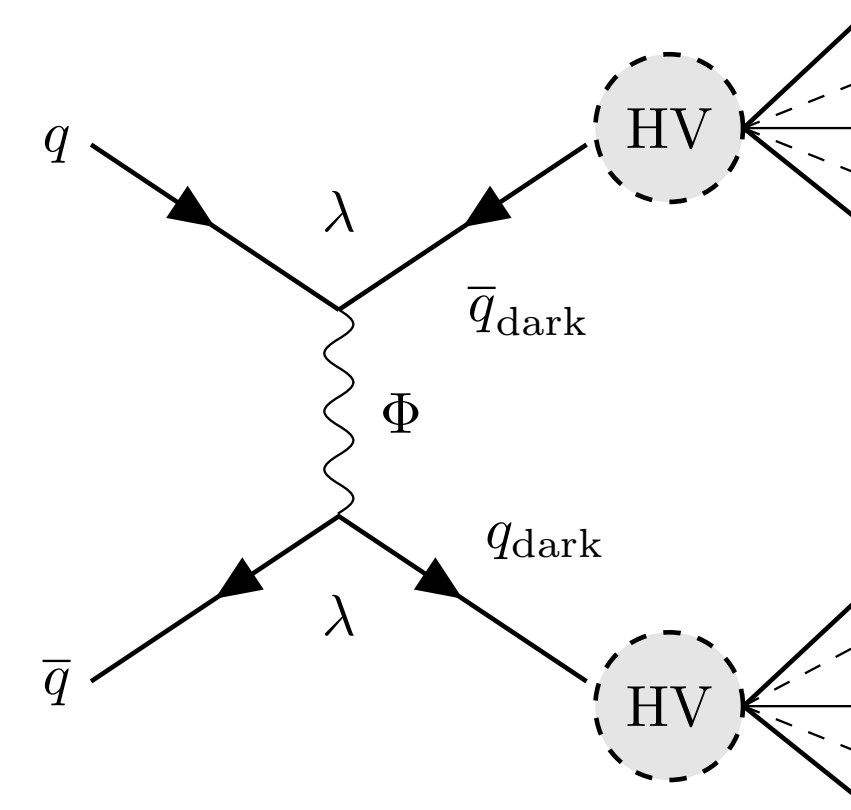

95% CL upper limits on λ

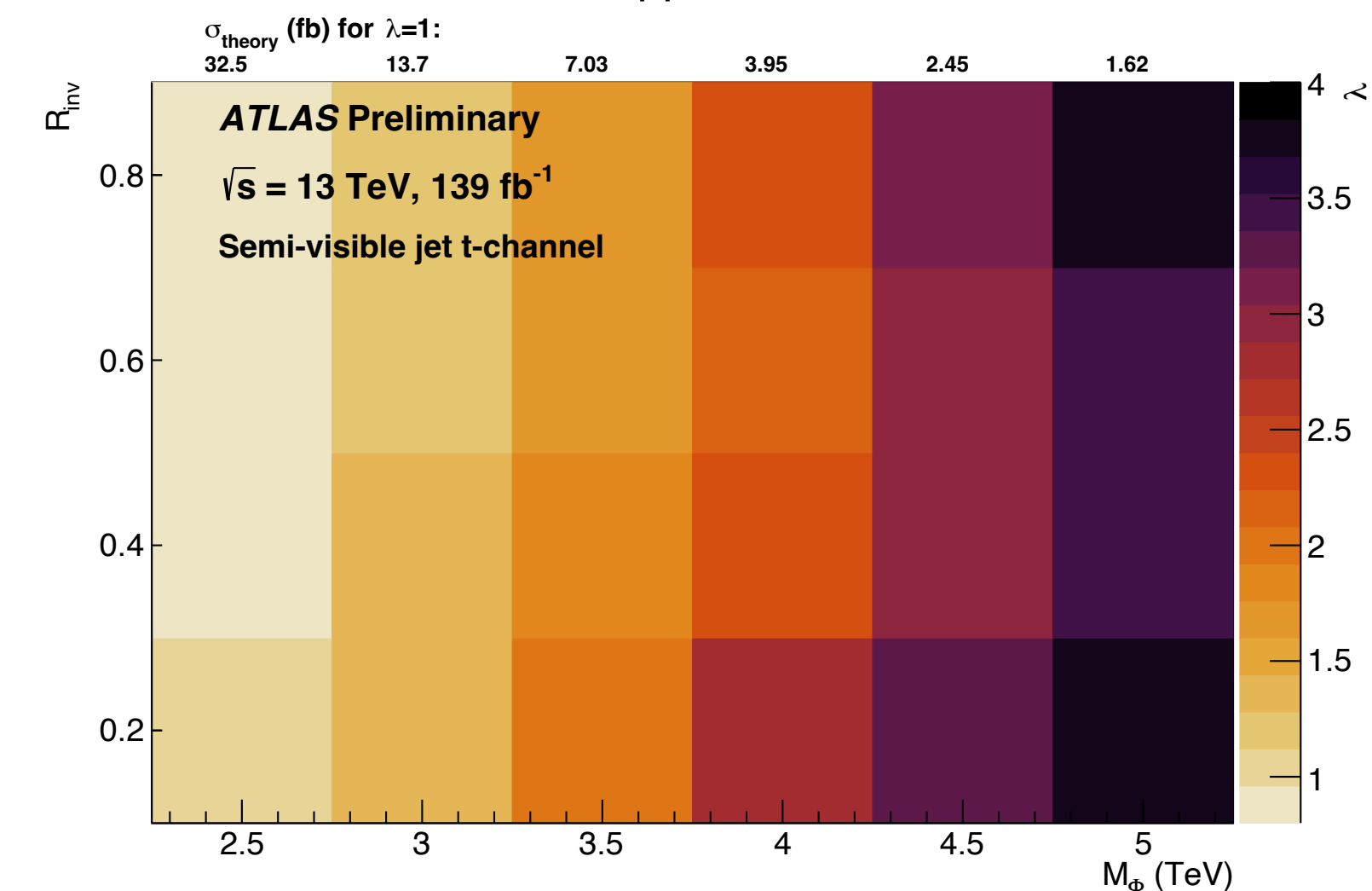

Searches for heavy resonances

ATLAS-CONF-2022-052

Many searches reaching few TeV sensitivity in mass

Leptoquark pair production

- LQ → te or tμ

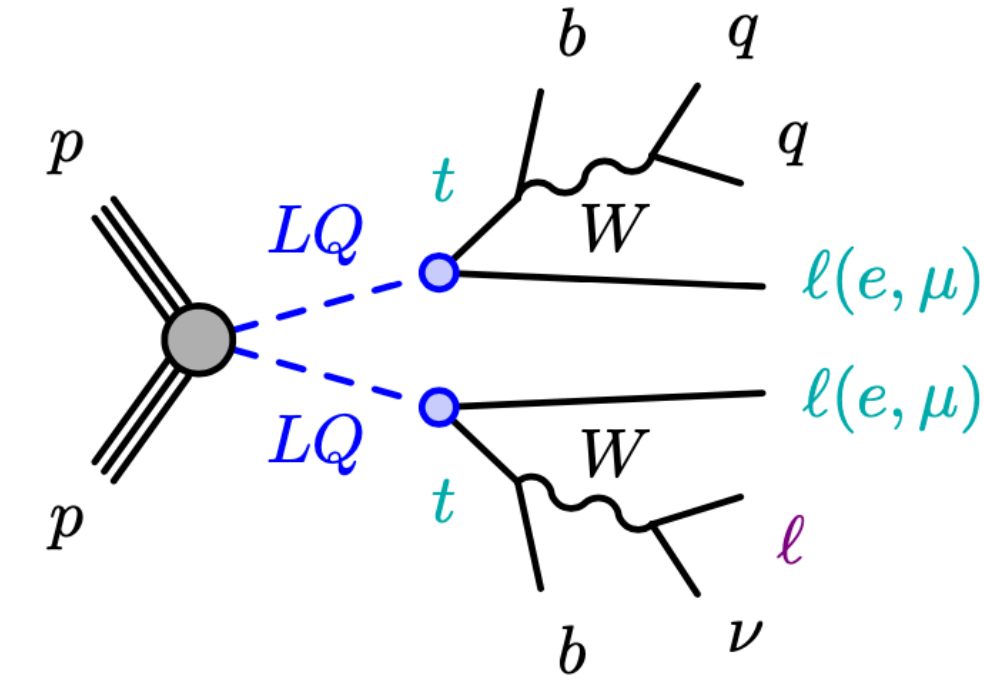

Mass reach

- 1.6 TeV (scalar LQ)
- 2 TeV (vector LQ)

ATLAS Heavy Particle Searches* - 95% CL Upper Exclusion Limits

Status: July 2022

ATLAS Preliminary

$\int \mathcal{L} dt = (3.6 - 139) \text{ fb}^{-1}$ $\sqrt{s} = 8, 13 \text{ TeV}$

Model	ℓ, γ	Jets†	E_T^{miss}	$\int \mathcal{L} dt [\text{fb}^{-1}]$	Limit	Reference
Extra dimensions	ADD $G_{KK} + g/q$	$0 e, \mu, \tau, \gamma$	$1-4 j$	Yes	139	M_D 11.2 TeV $n=2$ M_S 8.6 TeV $n=3$ HLZ NLO M_{th} 8.9 TeV $n=6$ M_{th} 9.55 TeV $n=6, M_D=3 \text{ TeV, rot BH}$
Gauge bosons	SSM $Z' \rightarrow \ell\ell$	$2 e, \mu$	-	-	139	Z' mass 5.1 TeV
CI	CI $qqqq$	-	$2 j$	-	37.0	Λ 21.8 TeV η_{LL}
DM	Axial-vector med. (Dirac DM)	$0 e, \mu, \tau, \gamma$	$1-4 j$	Yes	139	m_{med} 2.1 TeV
LQ	Scalar LQ 1 st gen	$2 e$	$\geq 2 j$	Yes	139	LQ mass 1.8 TeV
Vector-like fermions	VLQ $TT \rightarrow Zt + X$	$2e/2\mu \geq 3e, \mu \geq 1b, \geq 1j$	-	-	139	T mass 1.4 TeV
Excited fermions	Excited quark $q^* \rightarrow ag$	-	$2 j$	-	139	q^* mass 6.7 TeV
Other	Type III Seesaw	$2, 3, 4 e, \mu$	$\geq 2 j$	Yes	139	N^0 mass 910 GeV

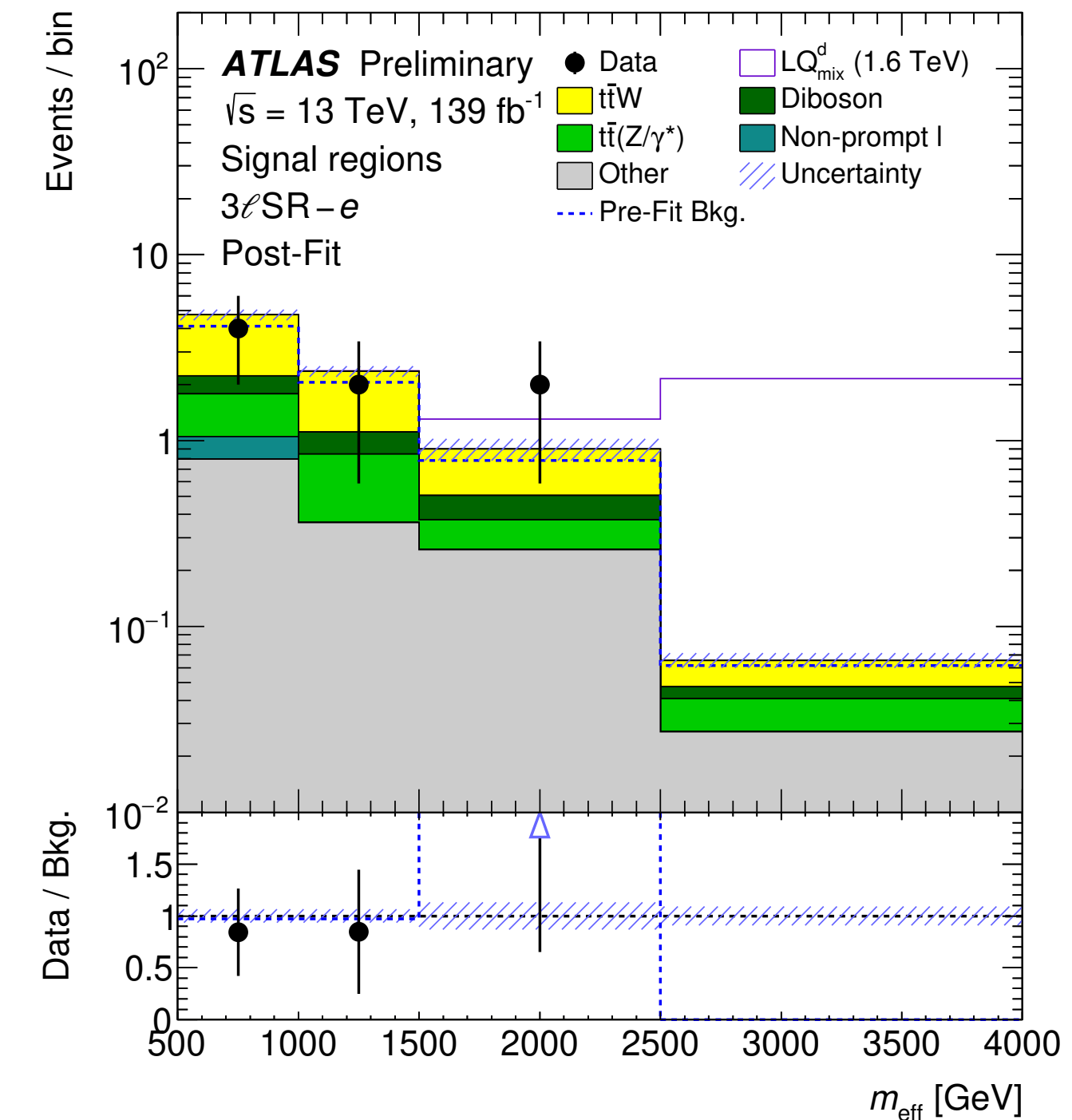

*Only a selection of the available mass limits on new states or phenomena is shown.

†Small-radius (large-radius) jets are denoted by the letter j (J).

Summary of pair-produced leptoquarks

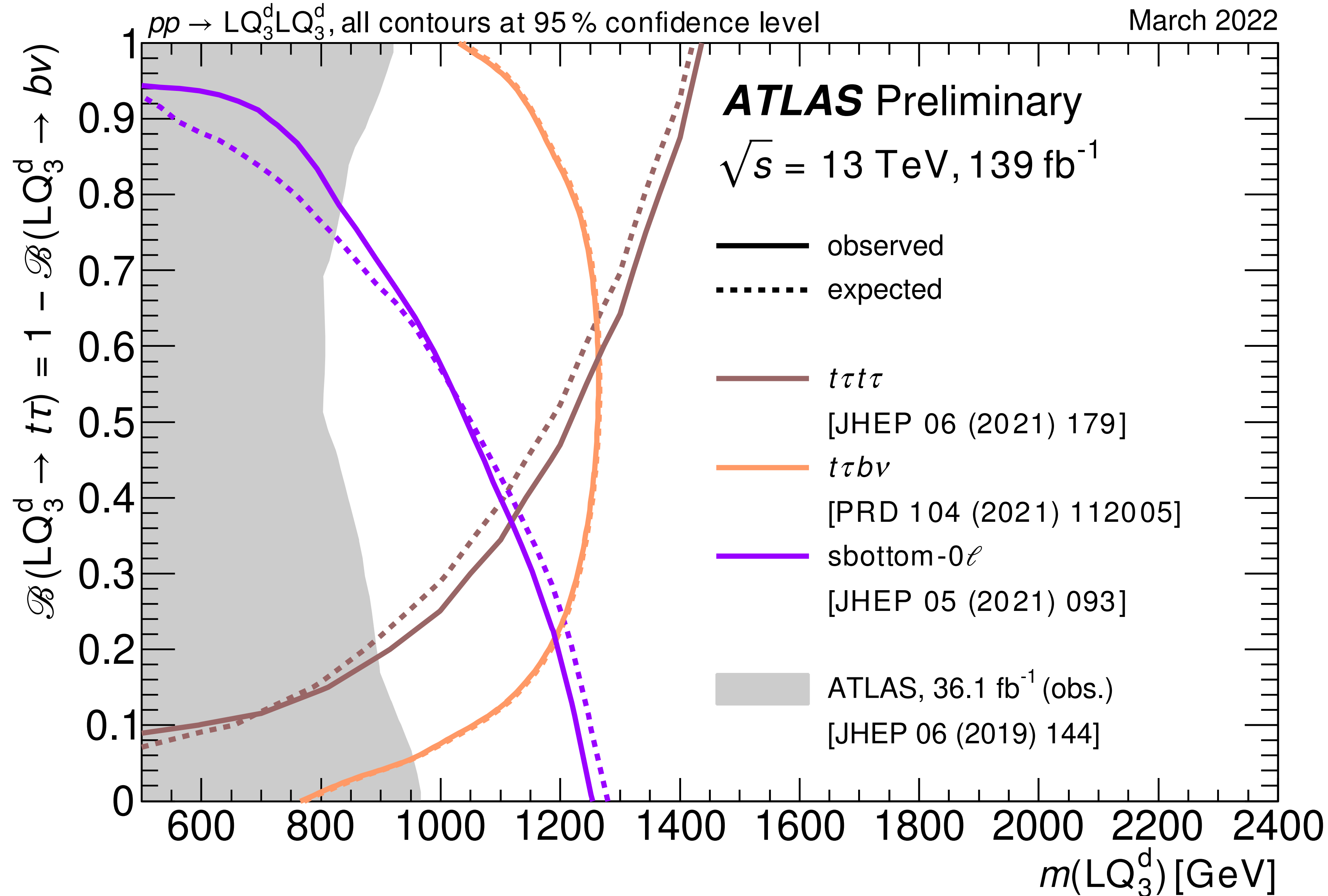

Scalar leptoquark in $b\tau\tau$ final state

ATLAS-CONF-2022-037

Search for singly-produced scalar leptoquarks

- complementary to pair-production searches
- $\tau_{\text{lep}}\tau_{\text{had}}$ and $\tau_{\text{had}}\tau_{\text{had}}$ final states, non-resonant production
- final discriminant = $\Sigma p_{\text{T}}(\tau, b)$

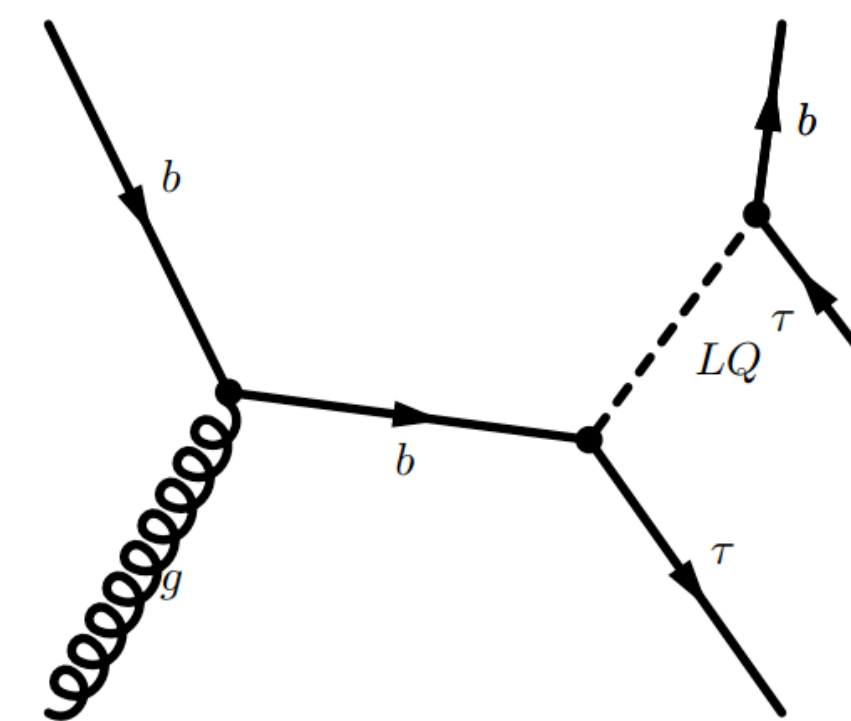

Top control region

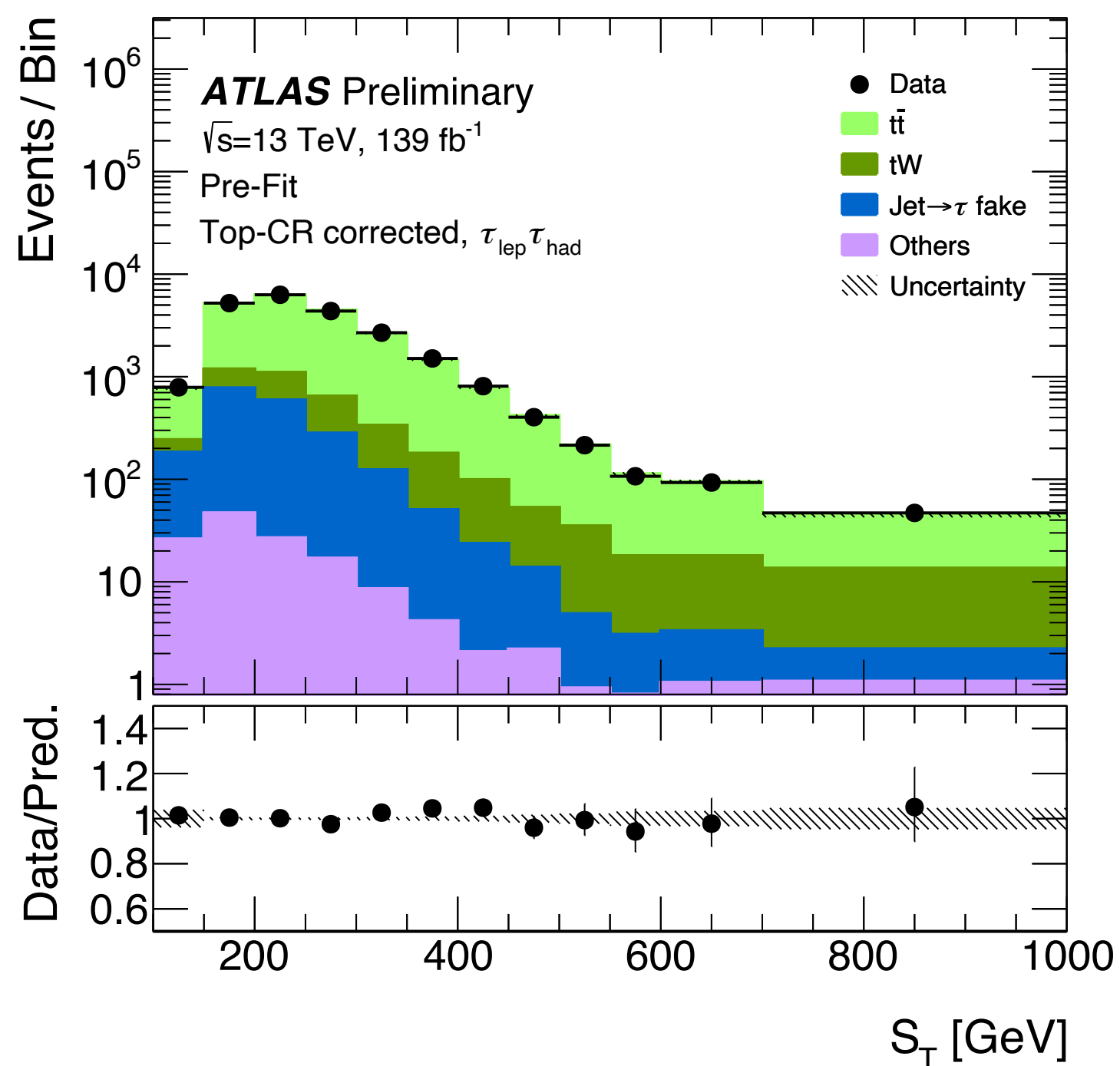

Signal region $S_{\text{T}} > 300$ GeV

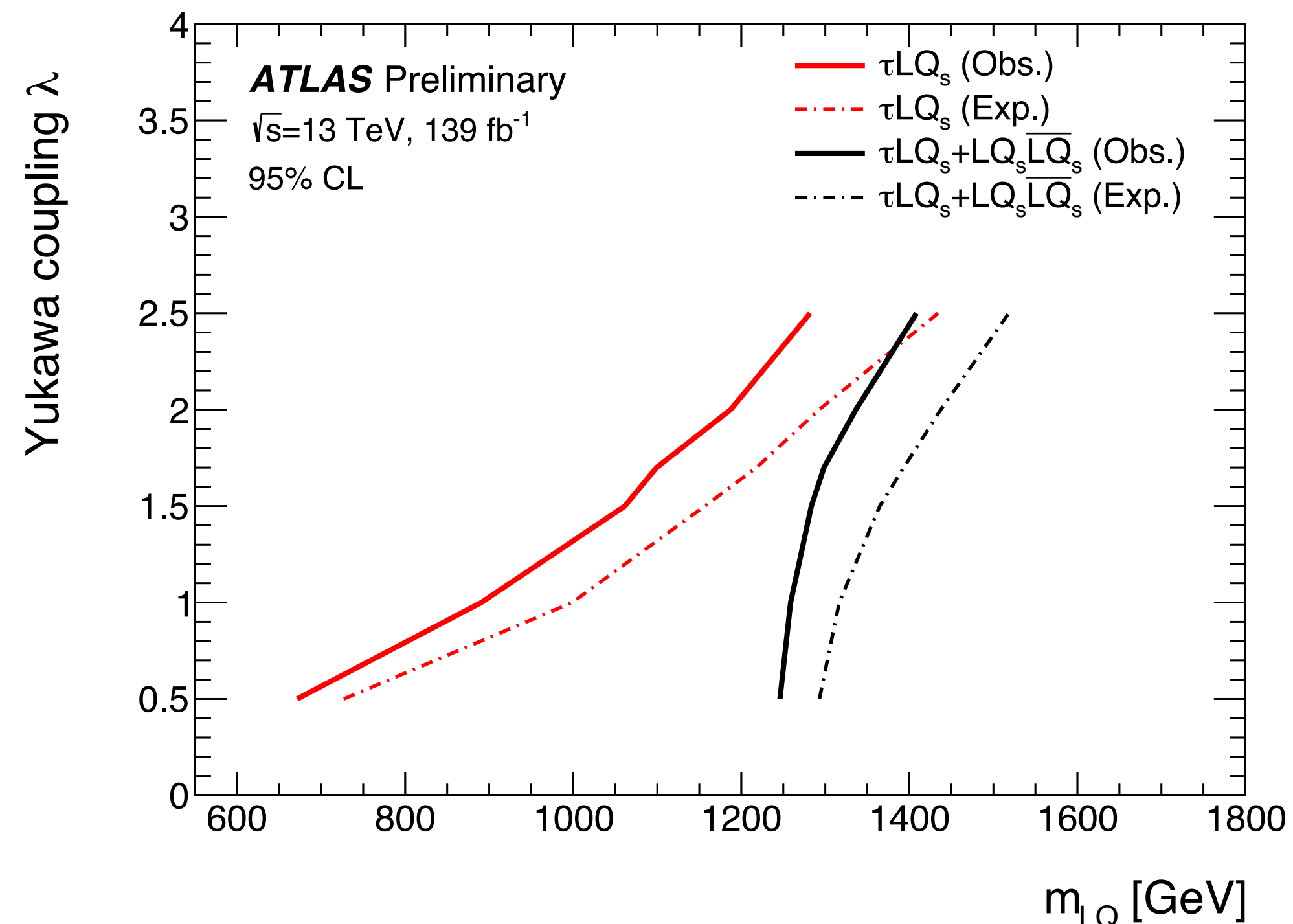
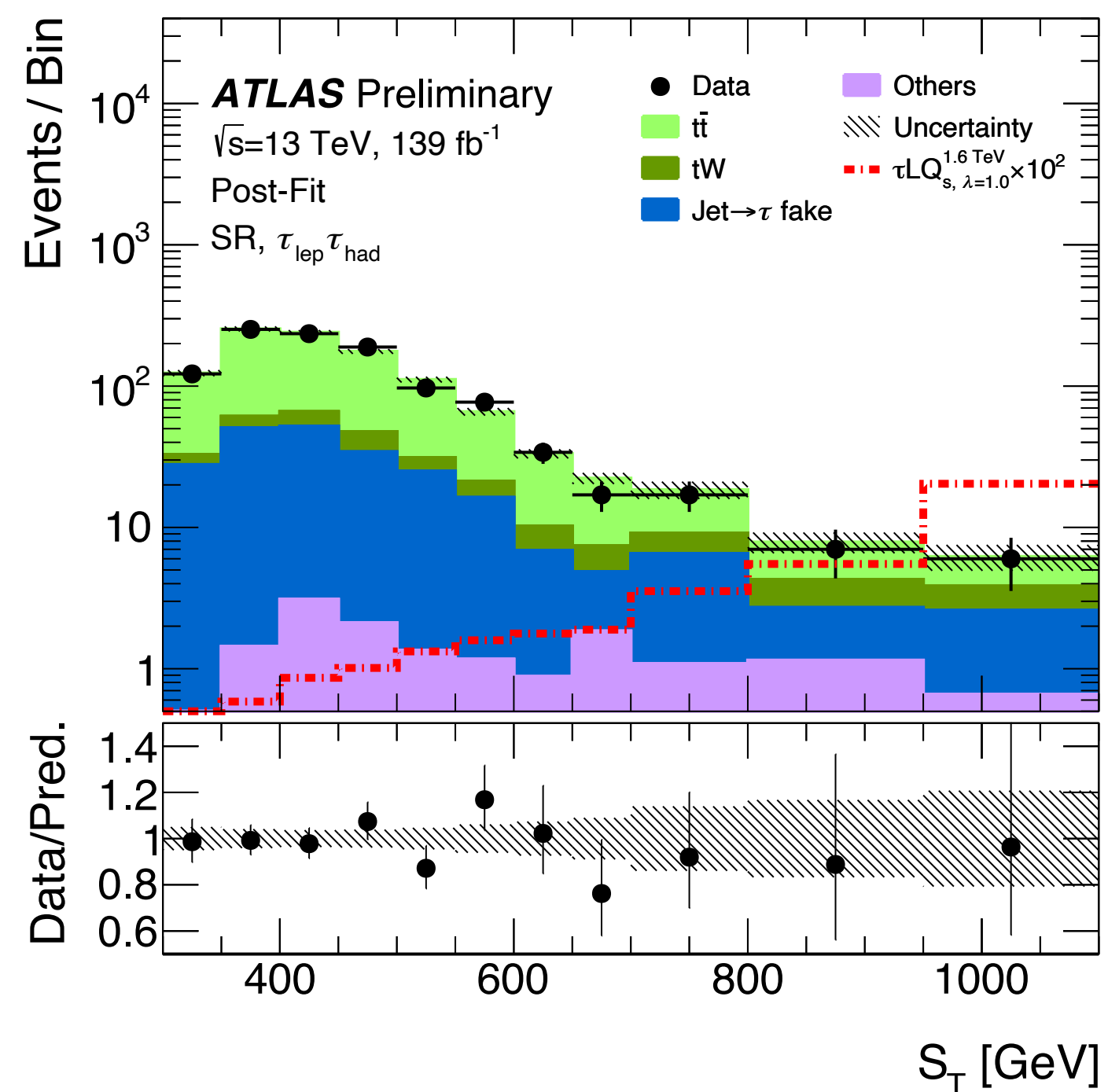

Searches for long-lived particles

Large program to search for long-lived particles exploiting a comprehensive set of signatures

- displaced vertices in inner tracking detector
- lepton not consistent with originating from pp vertex
- decay in the calorimeter or muon spectrometer
- dE/dx measurement for charged metastable particles + multi-charge

ATLAS Long-lived Particle Searches* - 95% CL Exclusion

Status: July 2022

ATLAS Preliminary
 $\int \mathcal{L} dt = (32.8 - 139) \text{ fb}^{-1}$
 $\sqrt{s} = 13 \text{ TeV}$

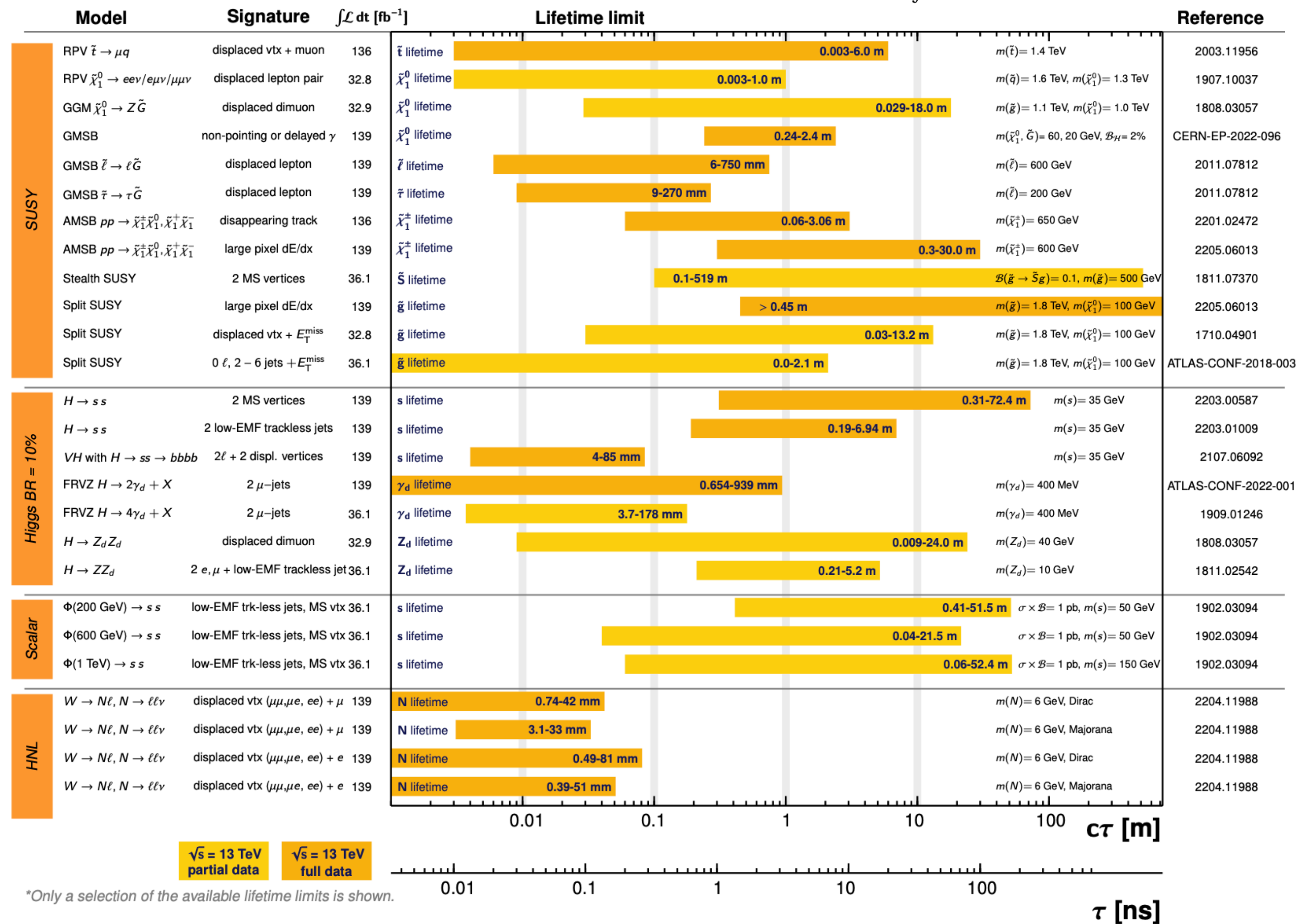

Searches for long-lived particles

ATLAS-CONF-2022-051

Search for H or Z produced far from interaction point

- exploiting calorimeter pointing to reconstructed vertex + photon time
- interpretation in GMSB model with LL NLSP
- reach 350/700 GeV for 2 ns lifetime for decay to H / Z

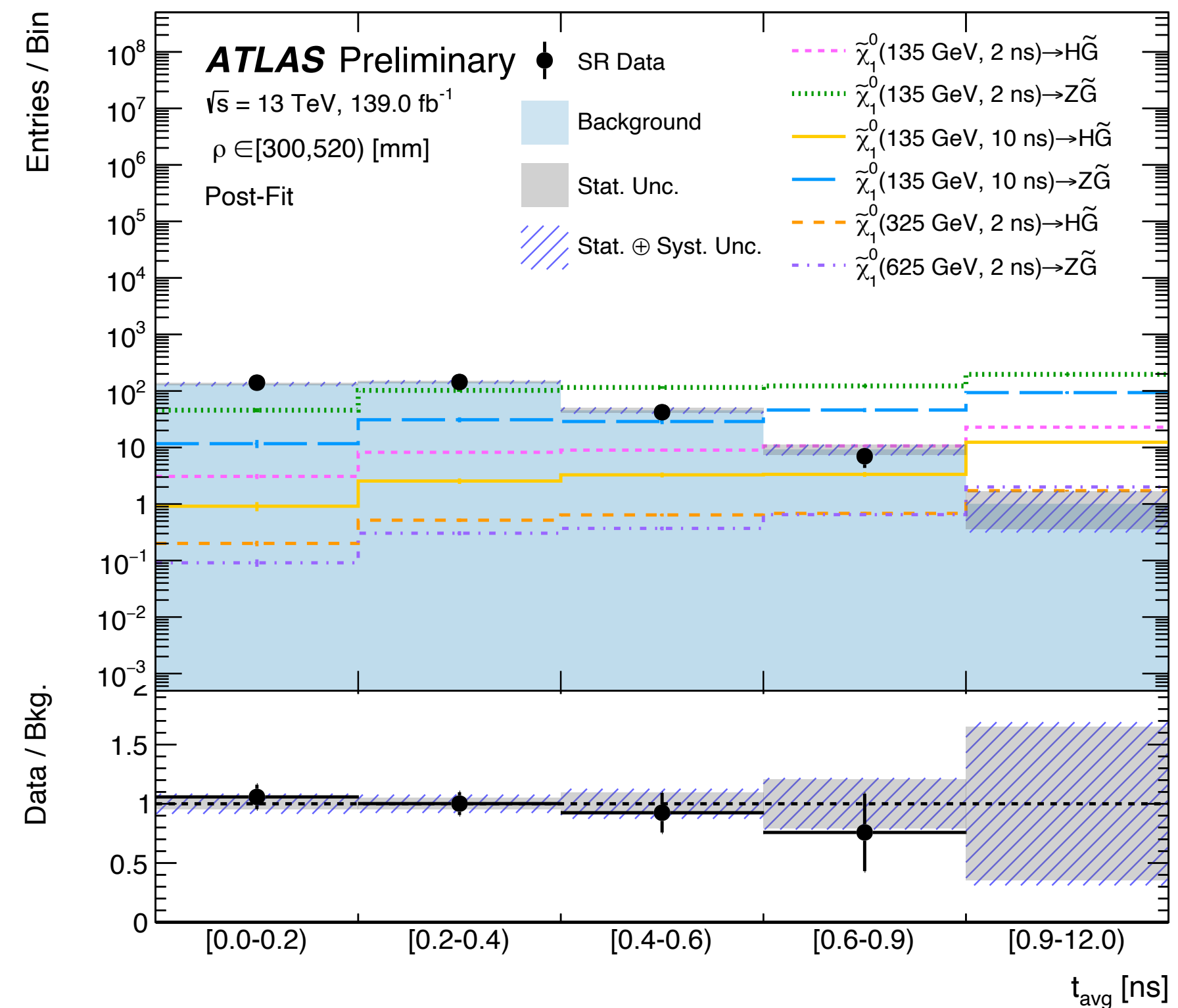
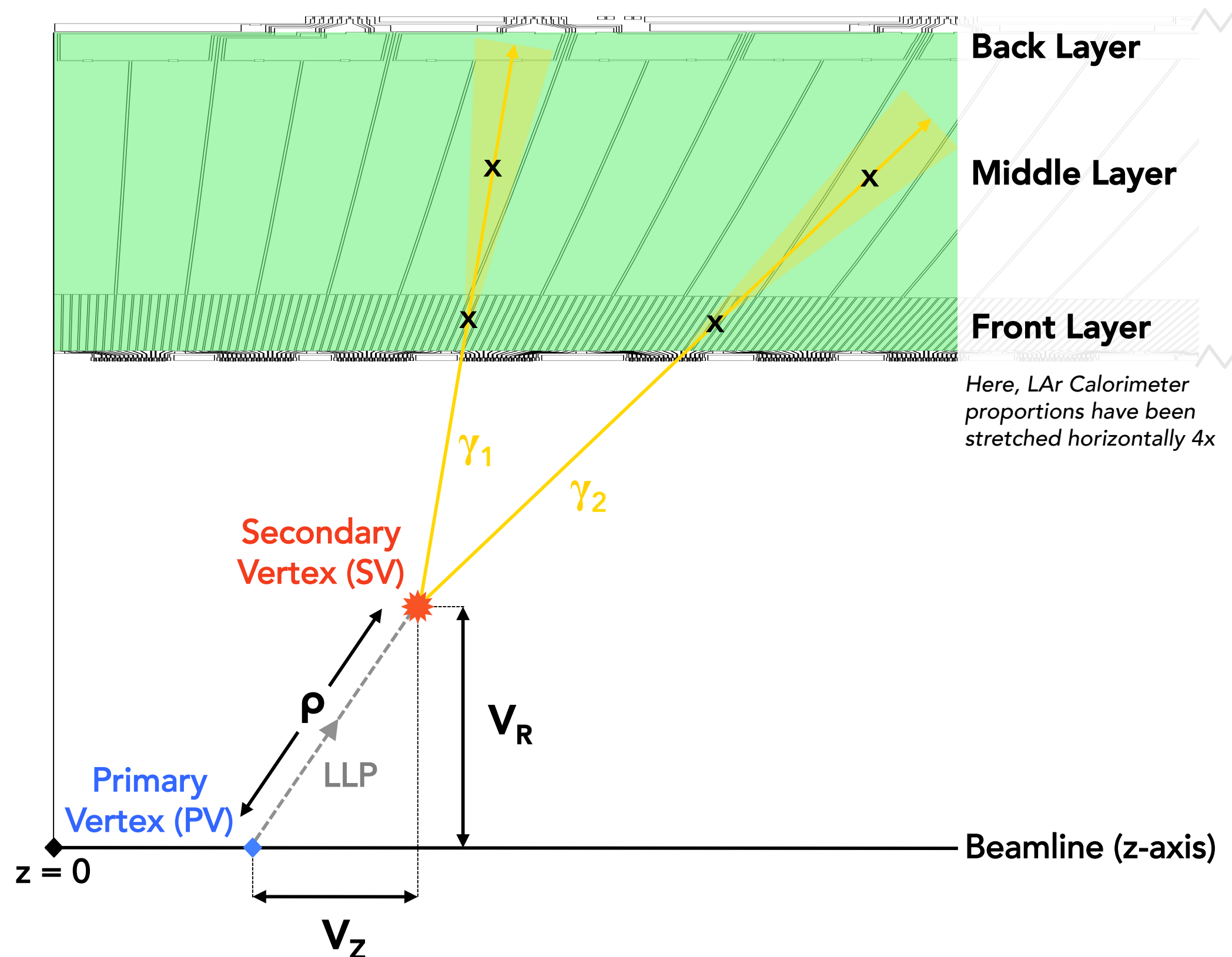
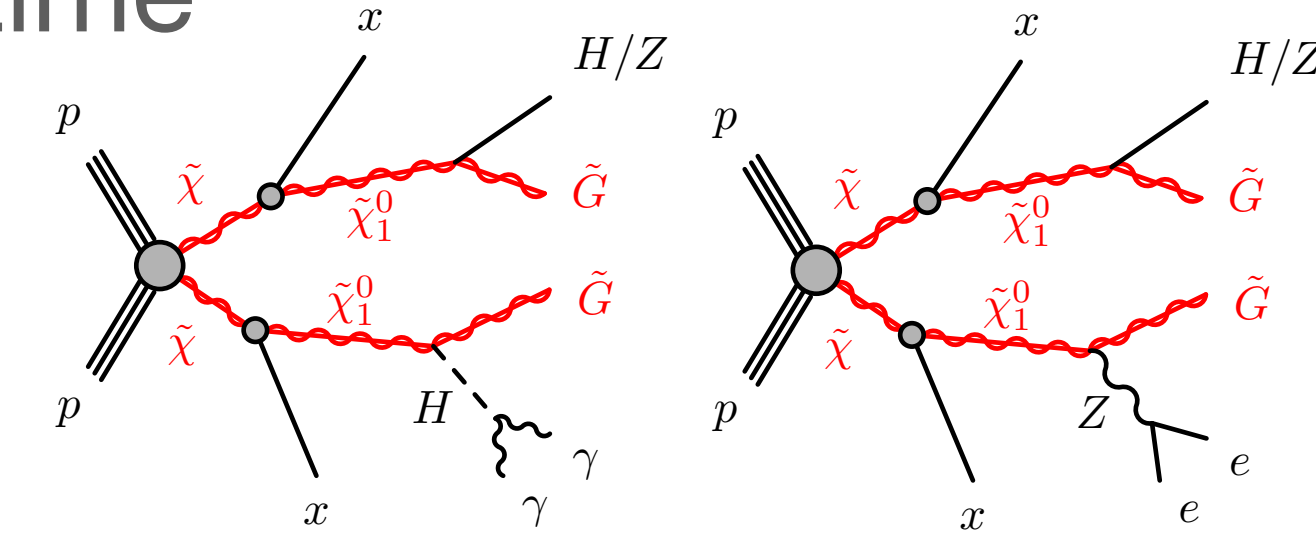

Search for heavy, LLP with large dE/dx

arXiv:2205.06013

Signal particles should

- move significantly slower than c, have high p_T and have anomalously large dE/dx.
- reconstructed in the pixel layers probing $\tau = 1$ ns and $m = 0.1$ –3 TeV.

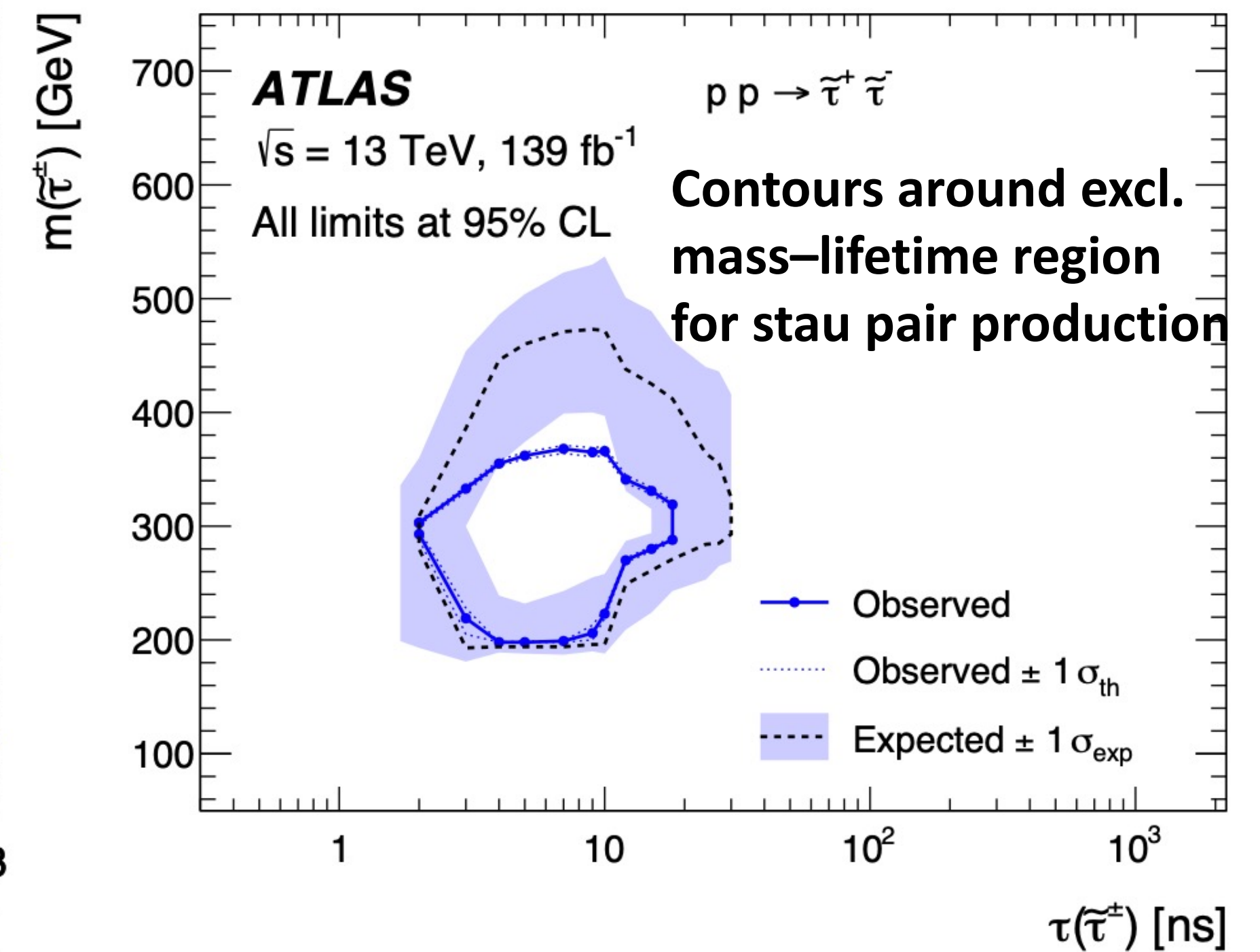
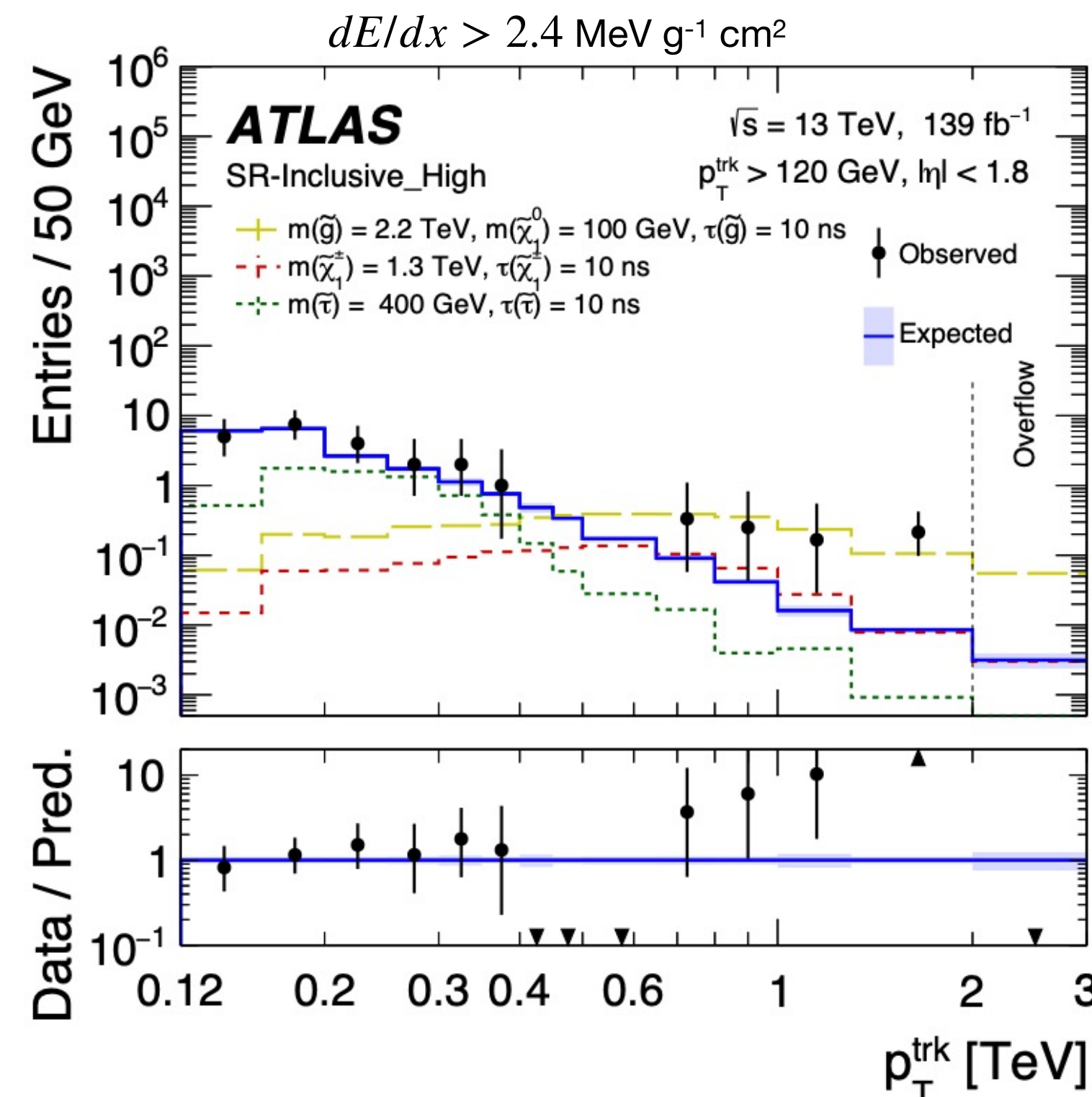
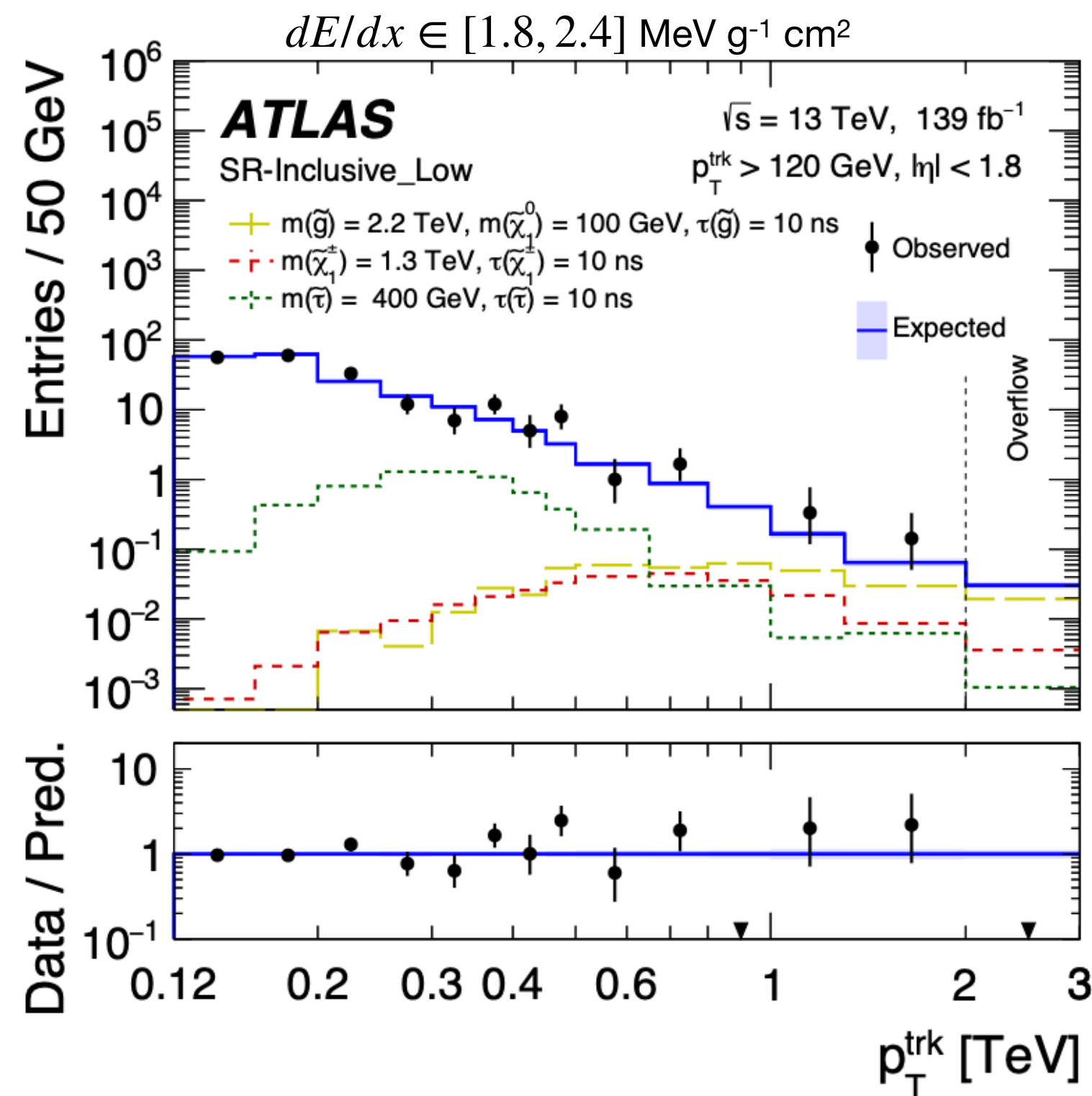

A 3.3σ excess is observed in ~ 1.4 TeV mass hypothesis, but close investigation (calorimeter, muon spectrometer) of the 7 tracks show $\beta \sim 1$

Search for displaced γ in exotic Higgs decays

ATLAS-CONF-2022-017

First LHC constraints on exotic Higgs-boson decays to displaced photons

- measurement relies on pointing and timing information from the LAr calorimeter

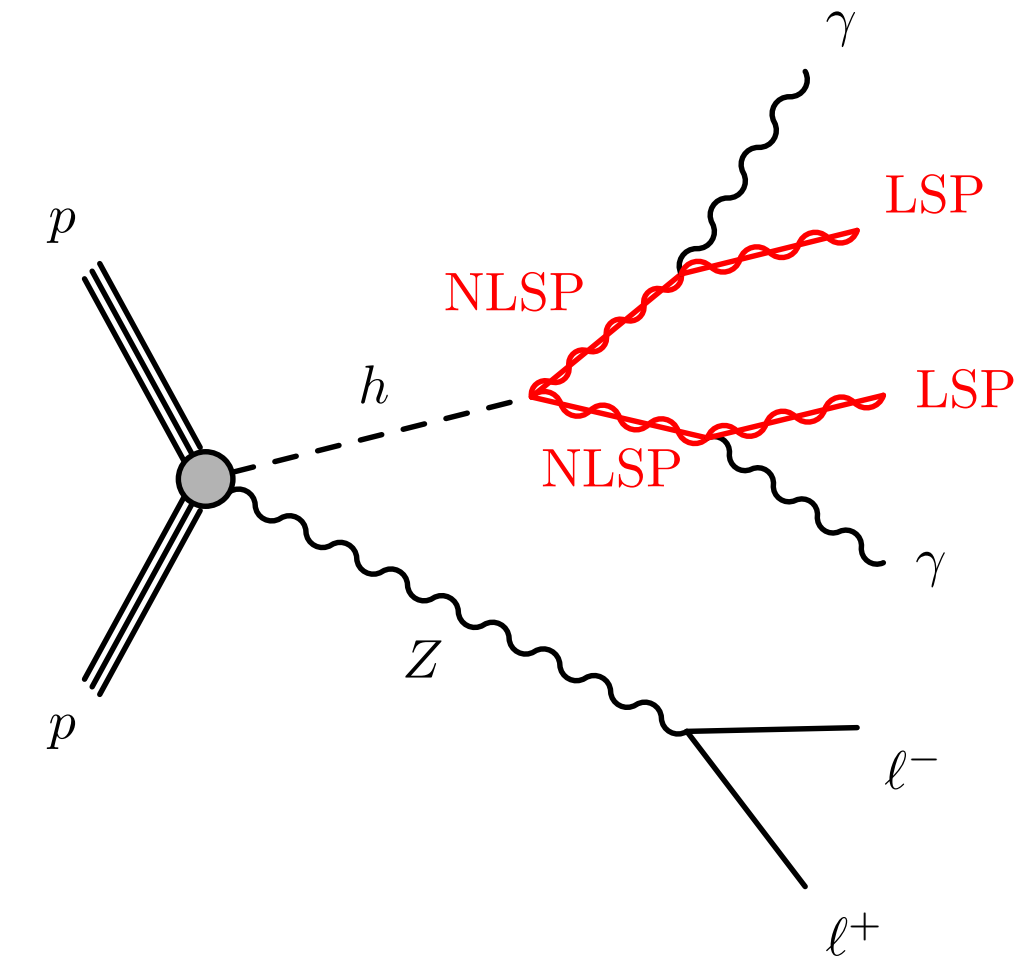
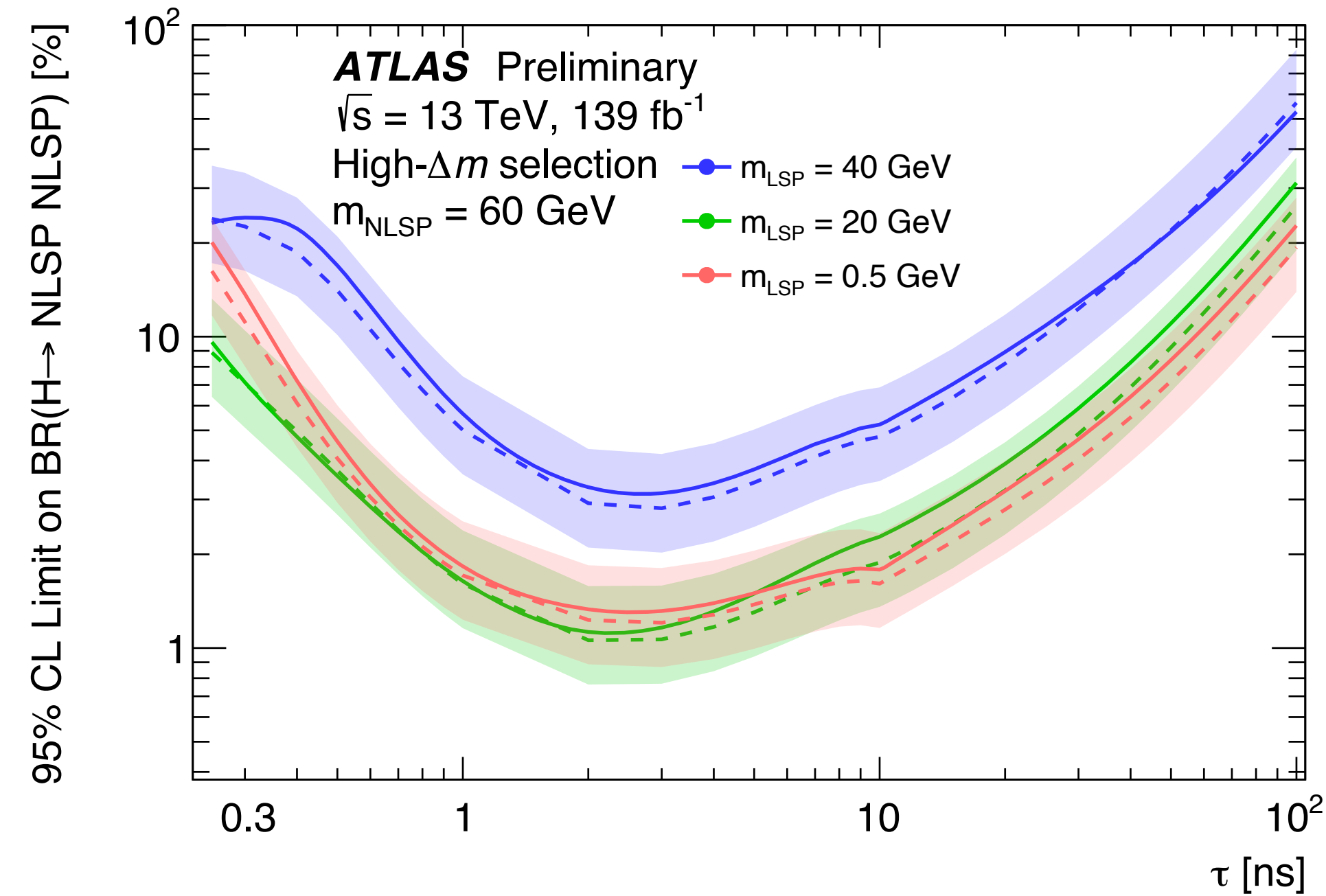
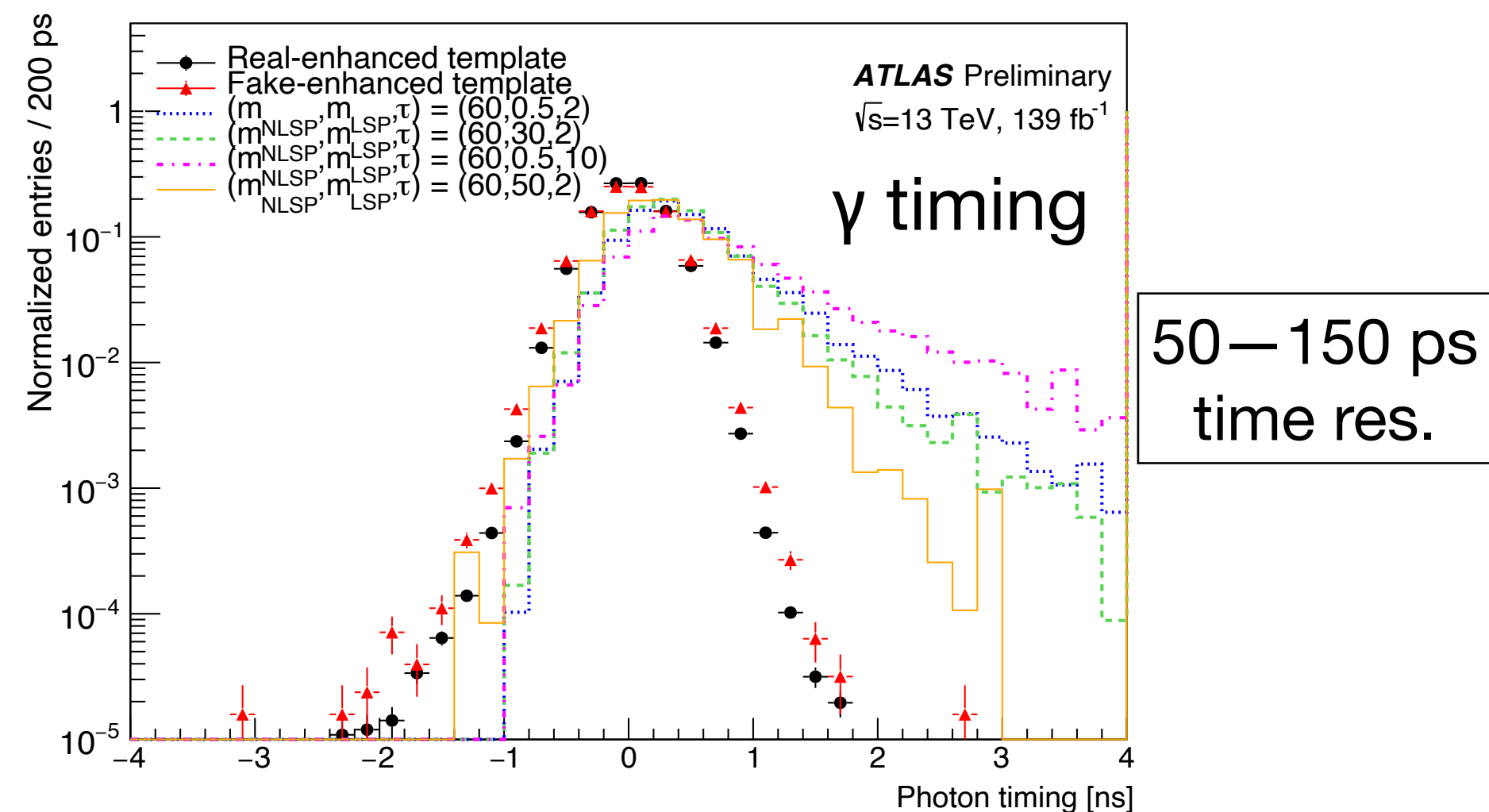
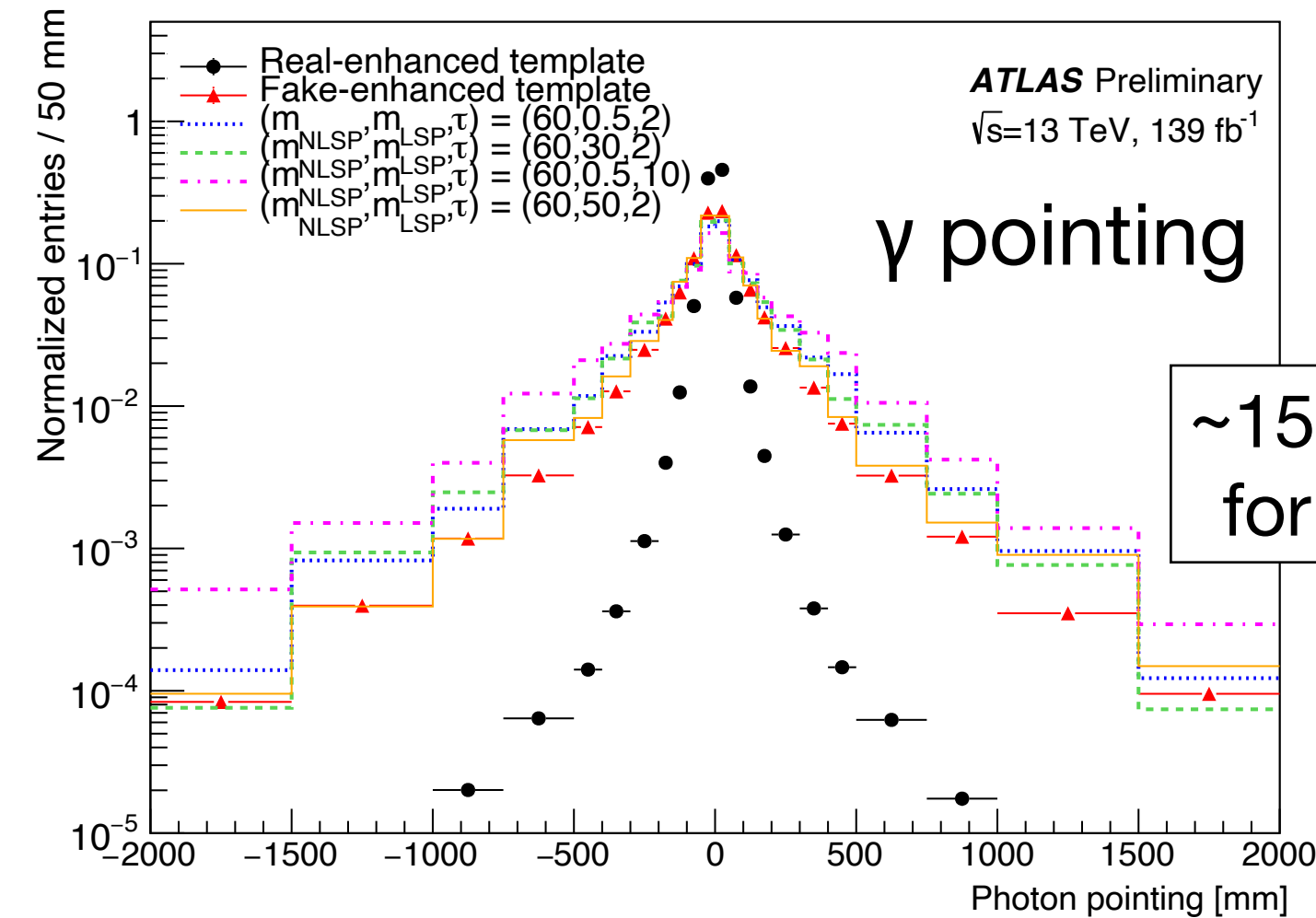

Data consistent with the SM-only scenario, limits are defined vs. LSP mass and NLSP lifetime for various NLSP masses.

Exotic Higgs decays summary

Branching ratios probed well below 10%

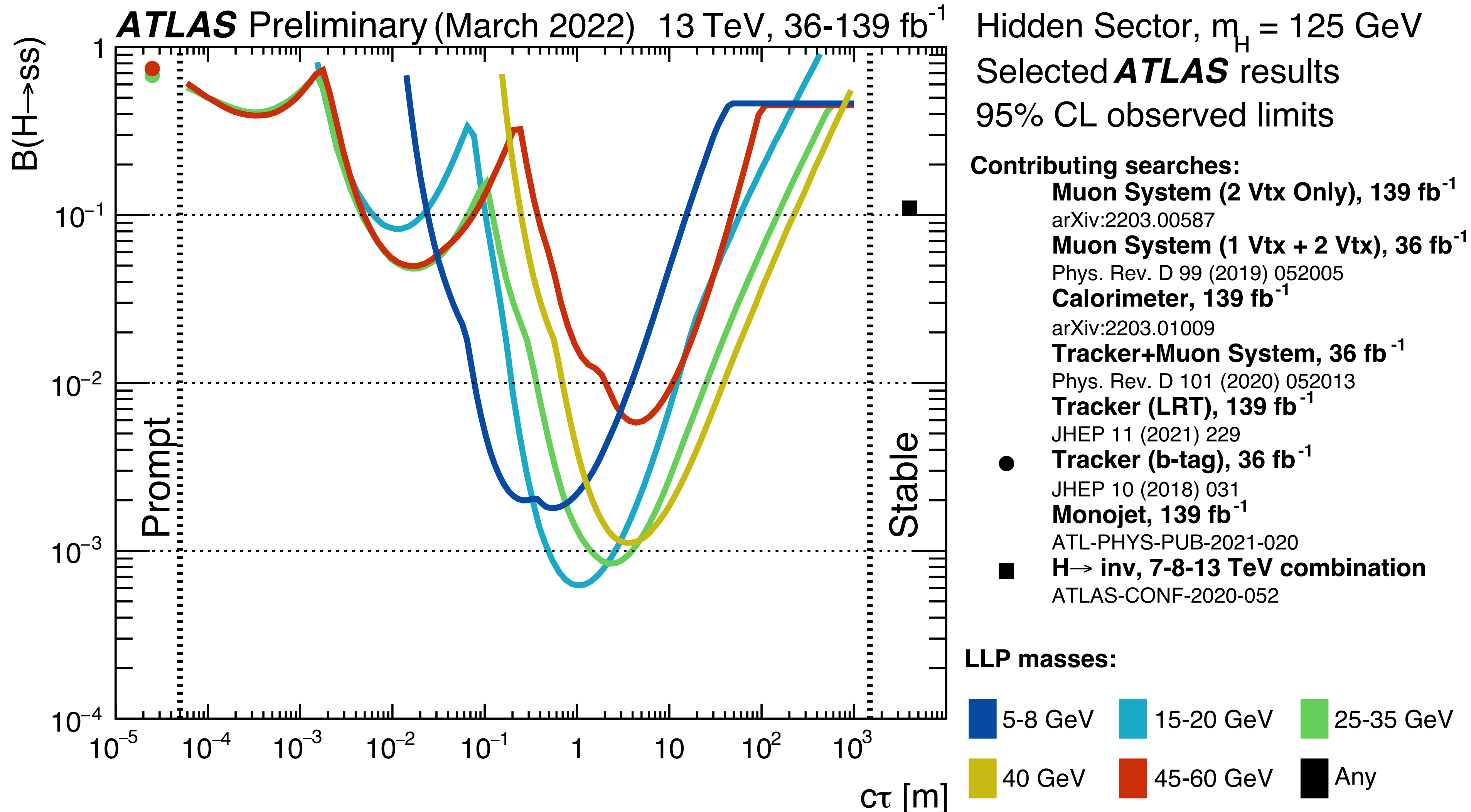

Effective field theory

Wilson coefficients in SMEFT

- systematic expansion of SM Lagrangian: look for BSM physics at higher energy scale
- combine Higgs-boson measurements, electroweak (di)boson measurements and constraints on electroweak parameters (from LEP/SLD)

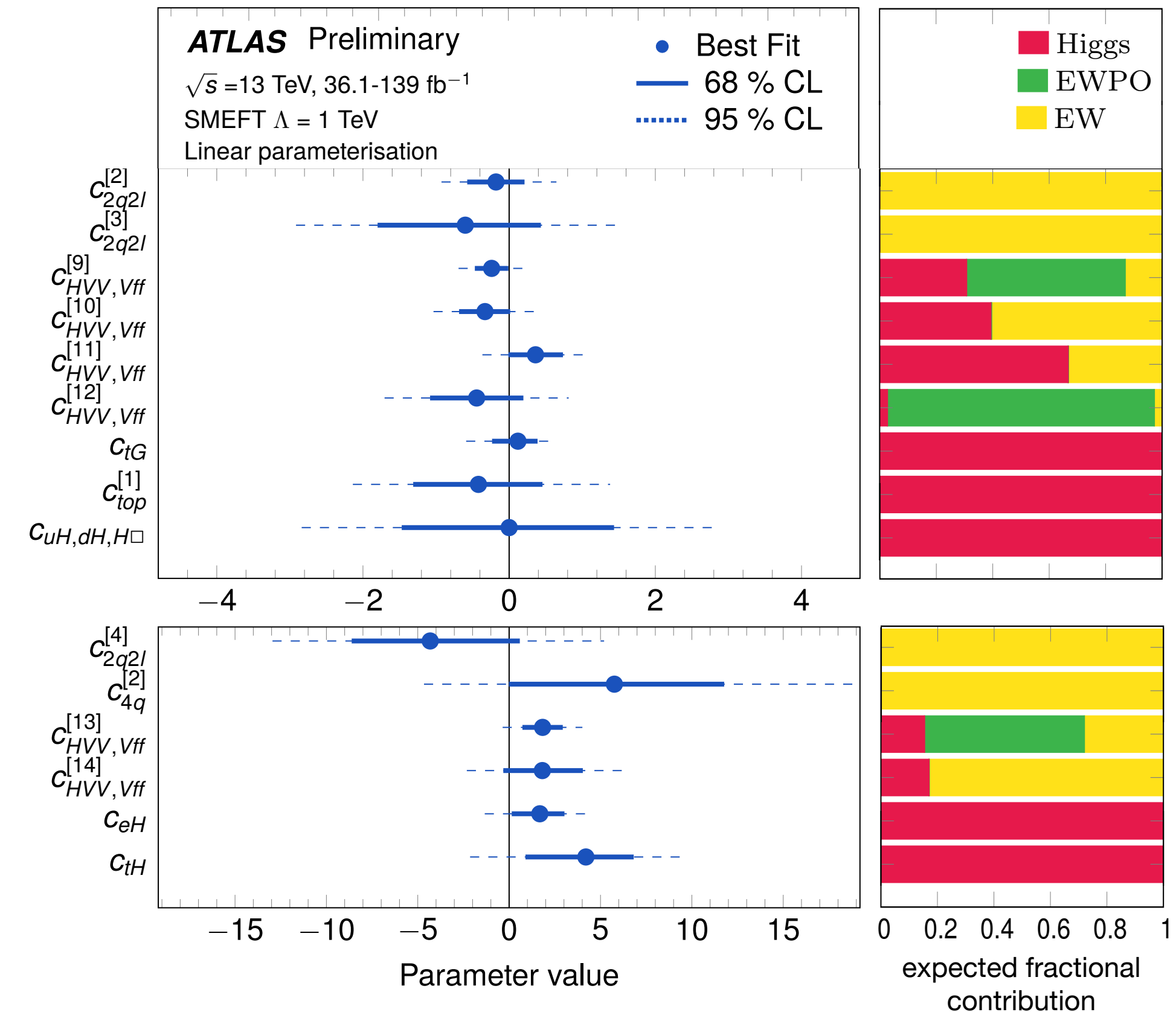
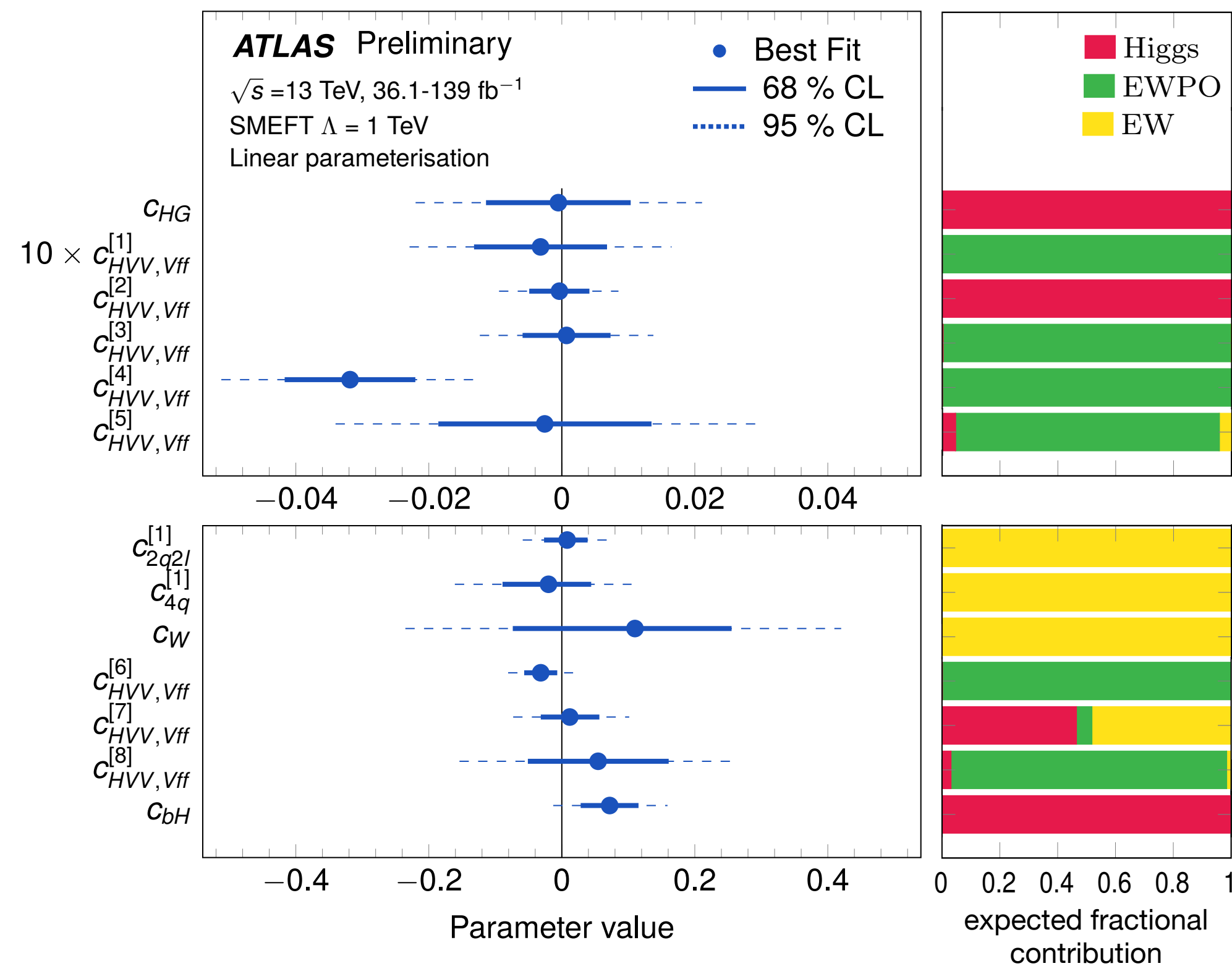

Physics with Pb Pb collisions

ATL-PHYS-PUB-2022-020

Comprehensive studies of jet quenching in quark-gluon plasma

- suppression in PbPb wrt pp via nuclear modification factor R_{AA} for

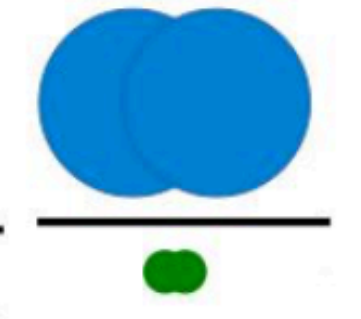
$$R_{AA} = \frac{1}{N_{\text{coll}}} \frac{\text{Scaled A+A}}{\text{pp}} = \frac{1}{N_{\text{coll}}} \frac{\frac{dN_{AA}}{dp_T}}{\frac{dN_{pp}}{dp_T}}$$

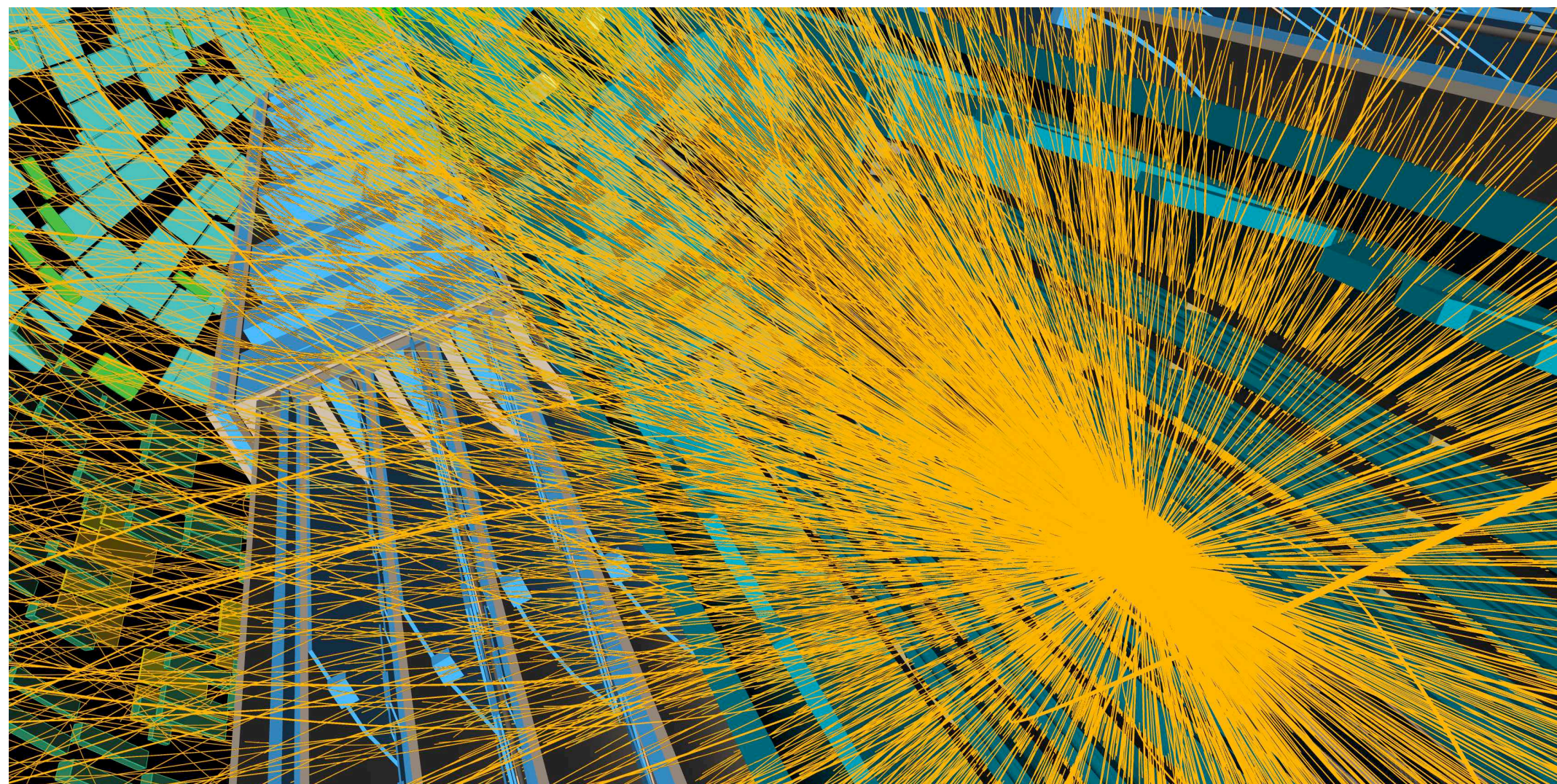
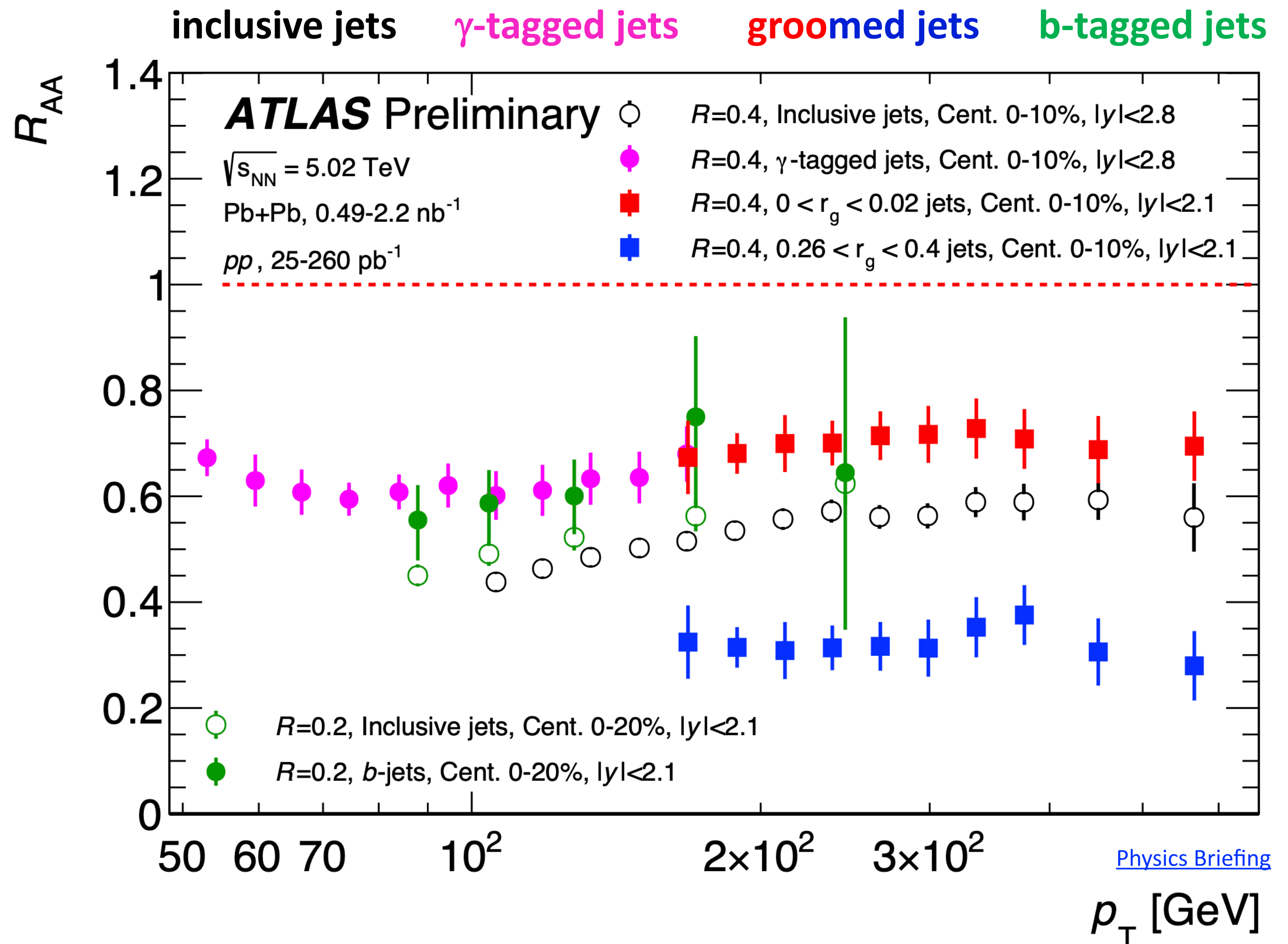

Physics with Pb Pb collisions

arXiv:2204.13478

Observation of the $\gamma\gamma \rightarrow \tau\tau$ process in ultra-peripheral collisions

- constraints on the τ -lepton anomalous magnetic moment

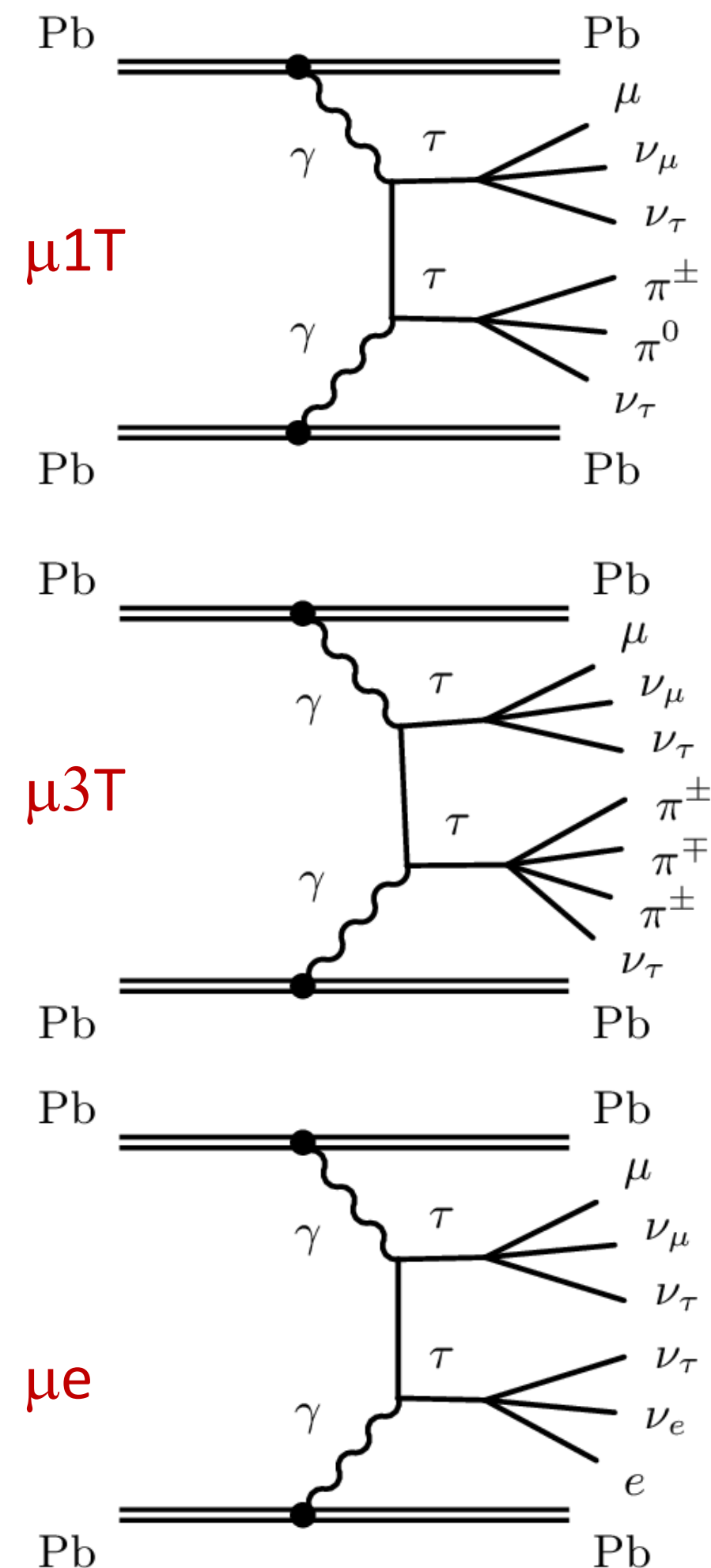

Look for τ production in 3 signal regions, measure $\mu_{\tau\tau} = 1.04 \pm 0.06$

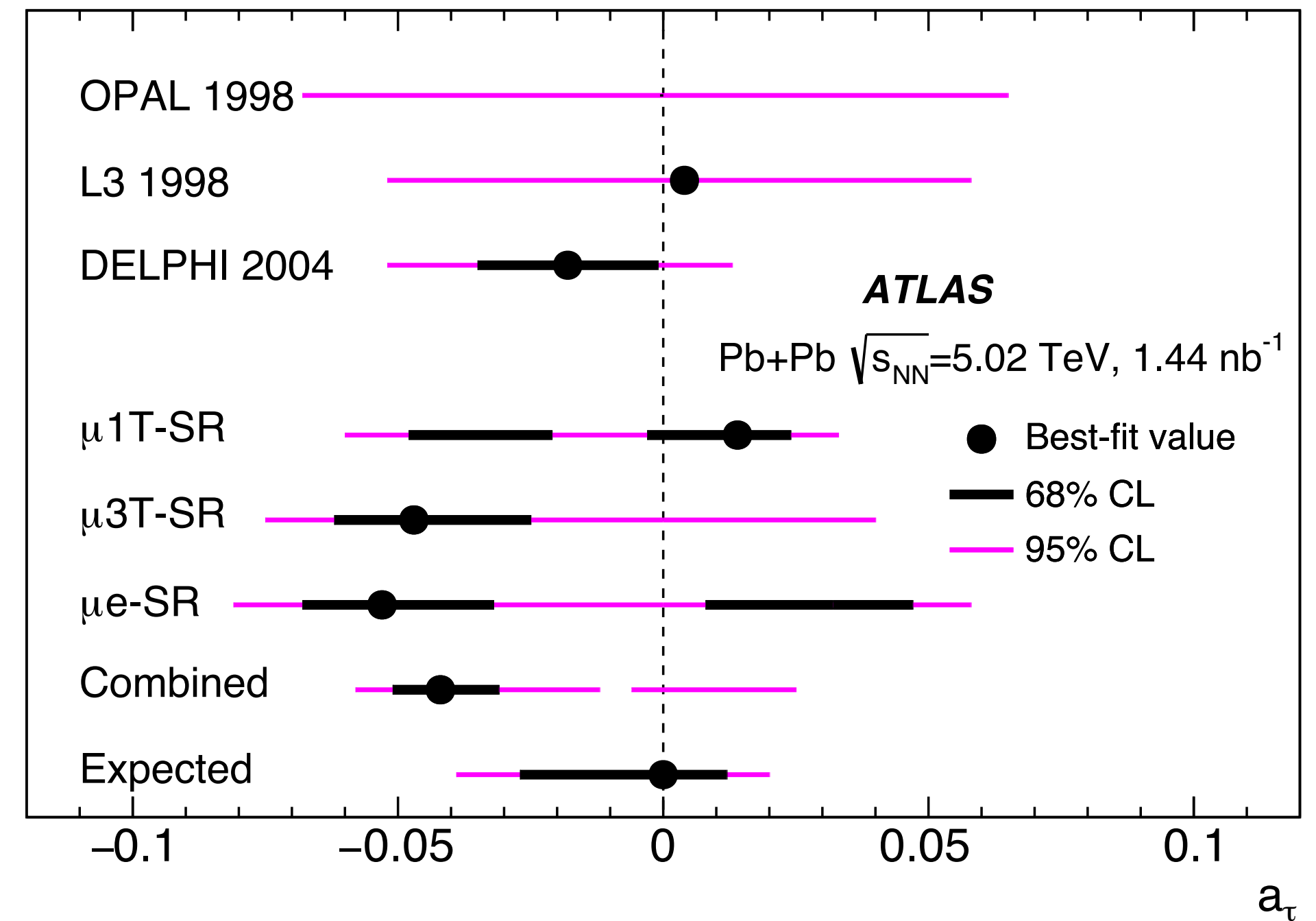
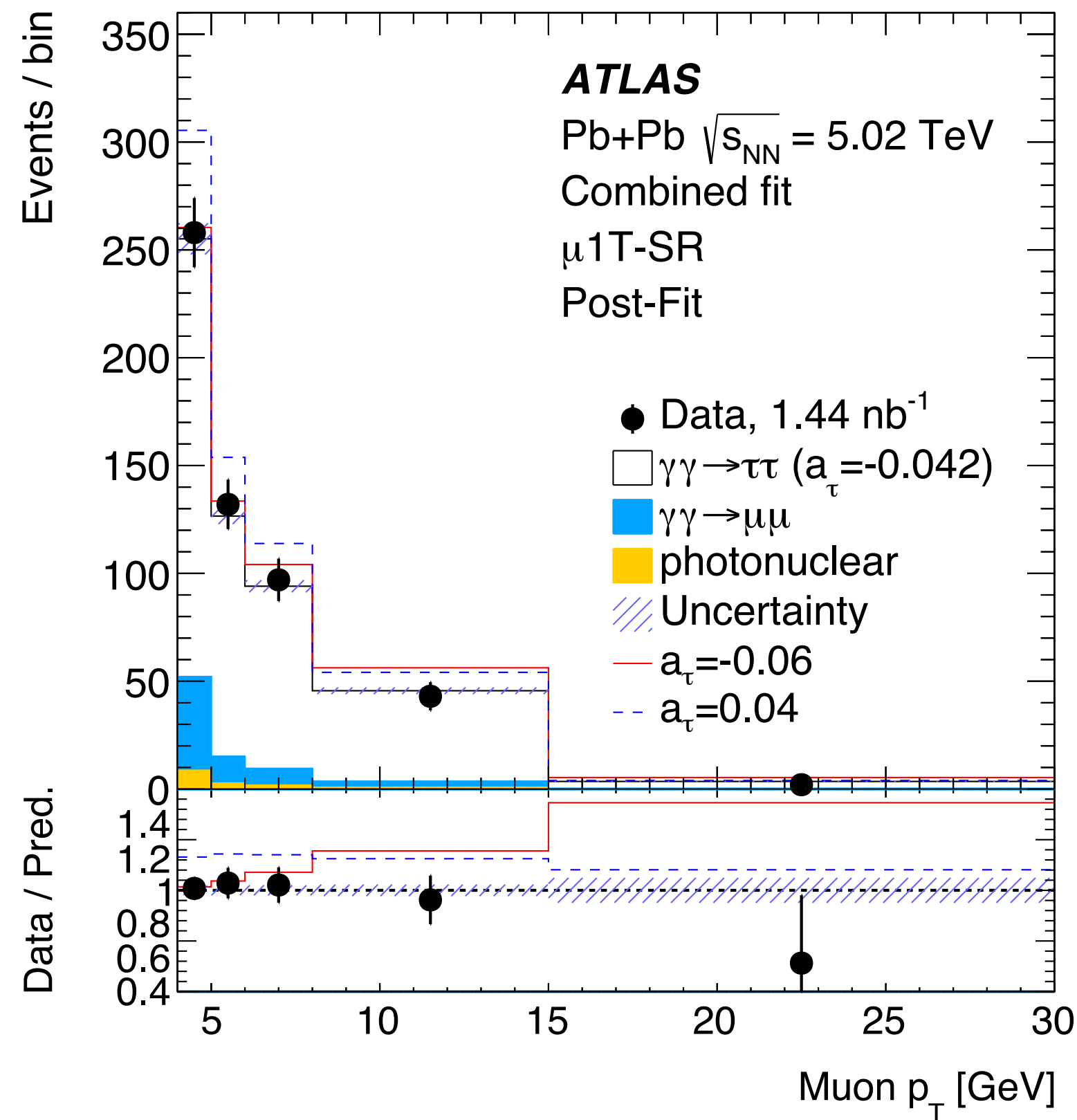

$p_T(\mu)$ sensitive to a_τ . Template fits to p_T



ATLAS

EXPERIMENT

Run: 366268

Event: 3305670439

2018-11-18 16:09:33 CEST

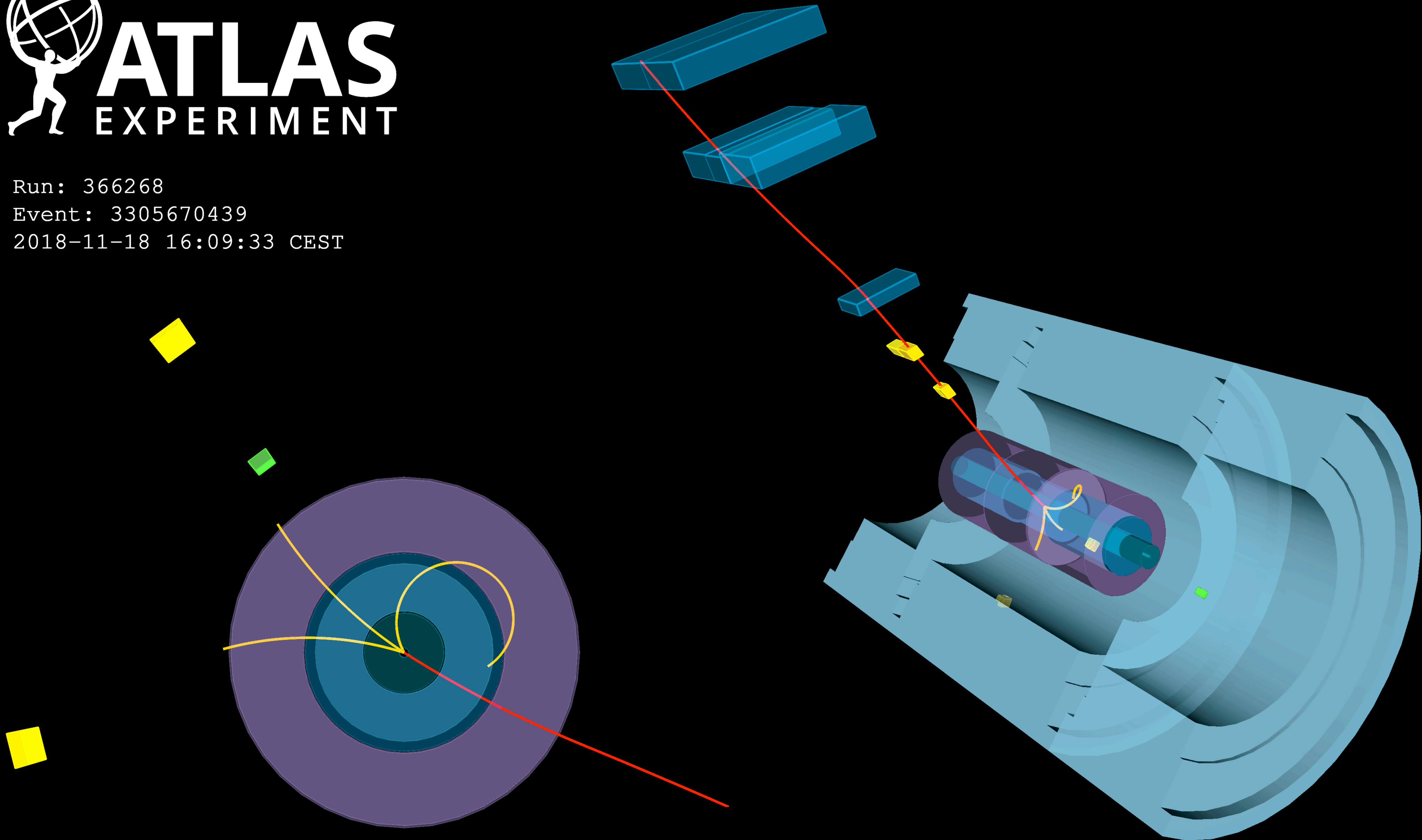

ATLAS for Run-3



MUON NEW SMALL WHEELS (NSW)

Installed new muon detectors with precision tracking and muon selection capabilities. Key preparation for the HL-LHC.



NEW READOUT SYSTEM FOR THE NSWs

The NSW system includes two million micromega readout channels and 350 000 small strip thin-gap chambers (sTGC) electronic readout channels.



LIQUID ARGON CALORIMETER

New electronics boards installed, increasing the granularity of signals used in event selection and improving trigger performance at higher luminosity.

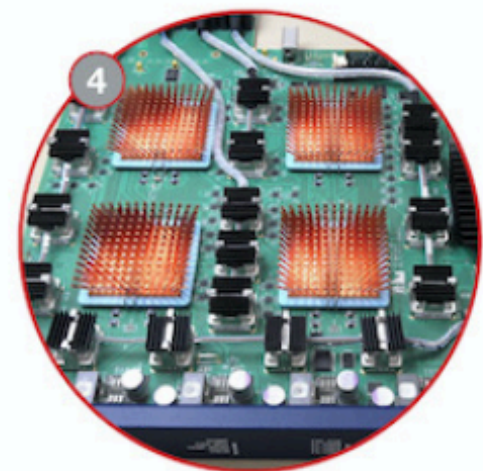

TRIGGER AND DATA ACQUISITION SYSTEM (TDAQ)

Upgraded hardware and software allowing the trigger to spot a wider range of collision events while maintaining the same acceptance rate.

NEW MUON CHAMBERS IN THE CENTRE OF ATLAS

Installed small monitored drift tube (sMDT) detectors alongside a new generation of resistive plate chamber (RPC) detectors, extending the trigger coverage in preparation for the HL-LHC.

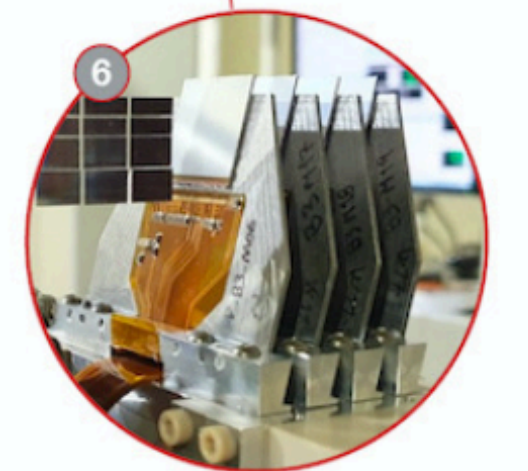
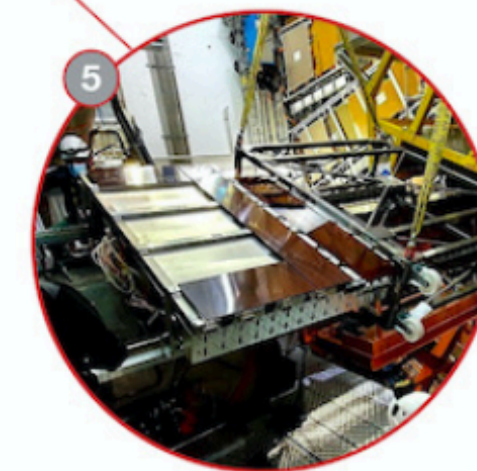

ATLAS FORWARD PROTON (AFP)

Re-designed AFP time-of-flight detector, allowing insertion into the LHC beamline with a new "out-of-vacuum" solution.

New Small Wheel

Muon trigger + measurement

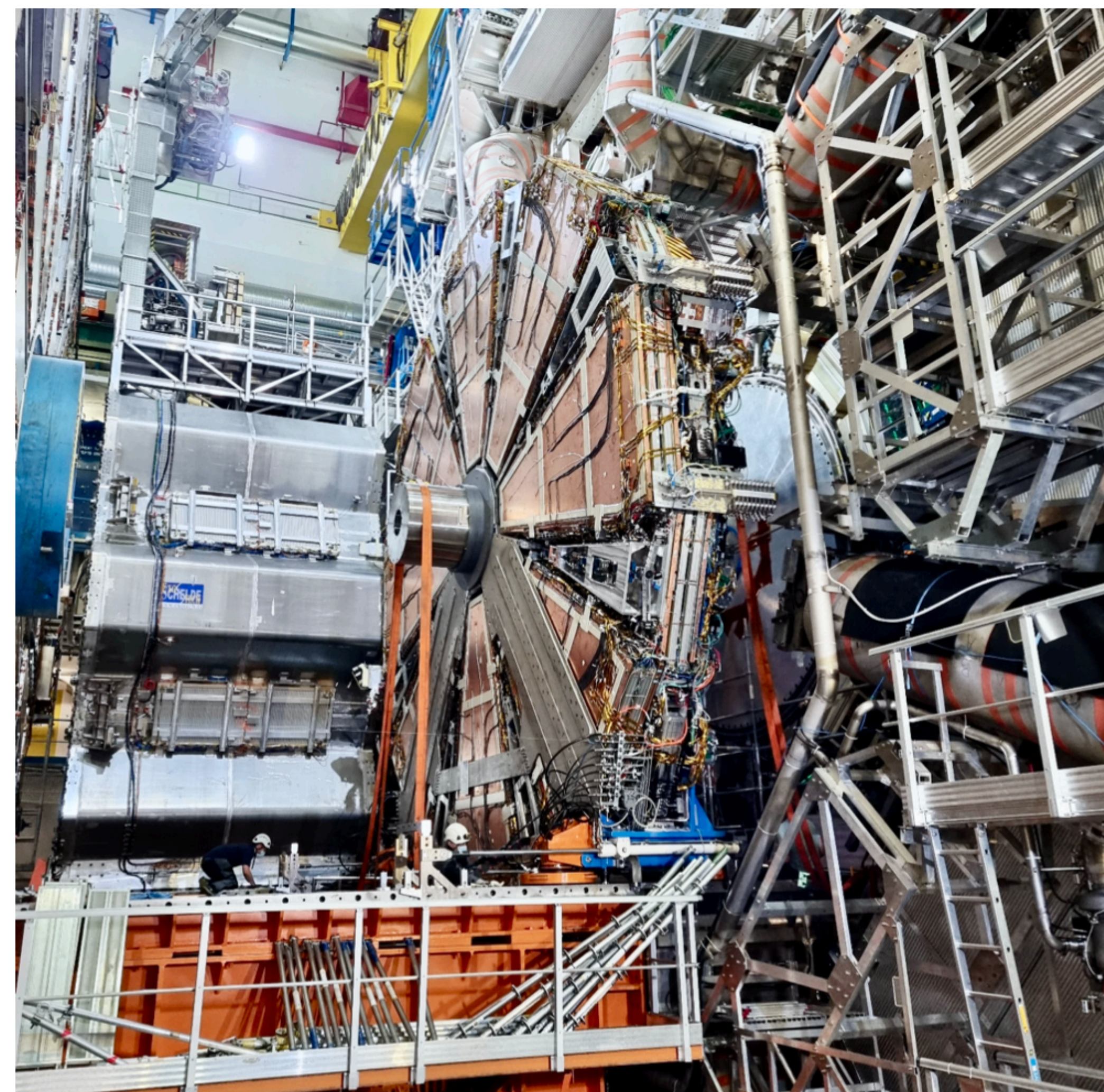

NSW being positioned

900 GeV pp collision data

Recorded in May

- during stable-beam periods provided by the LHC during its commissioning

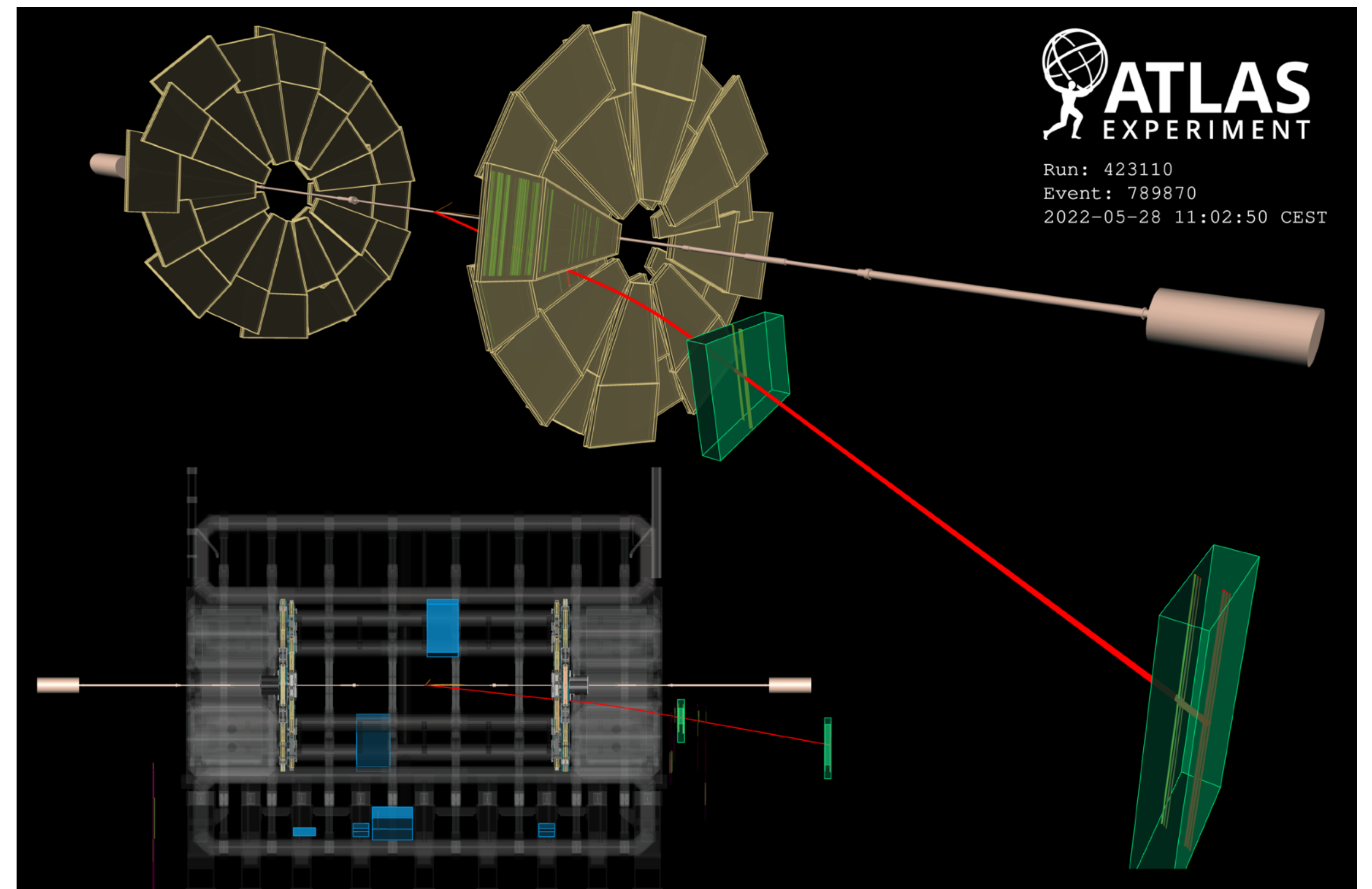
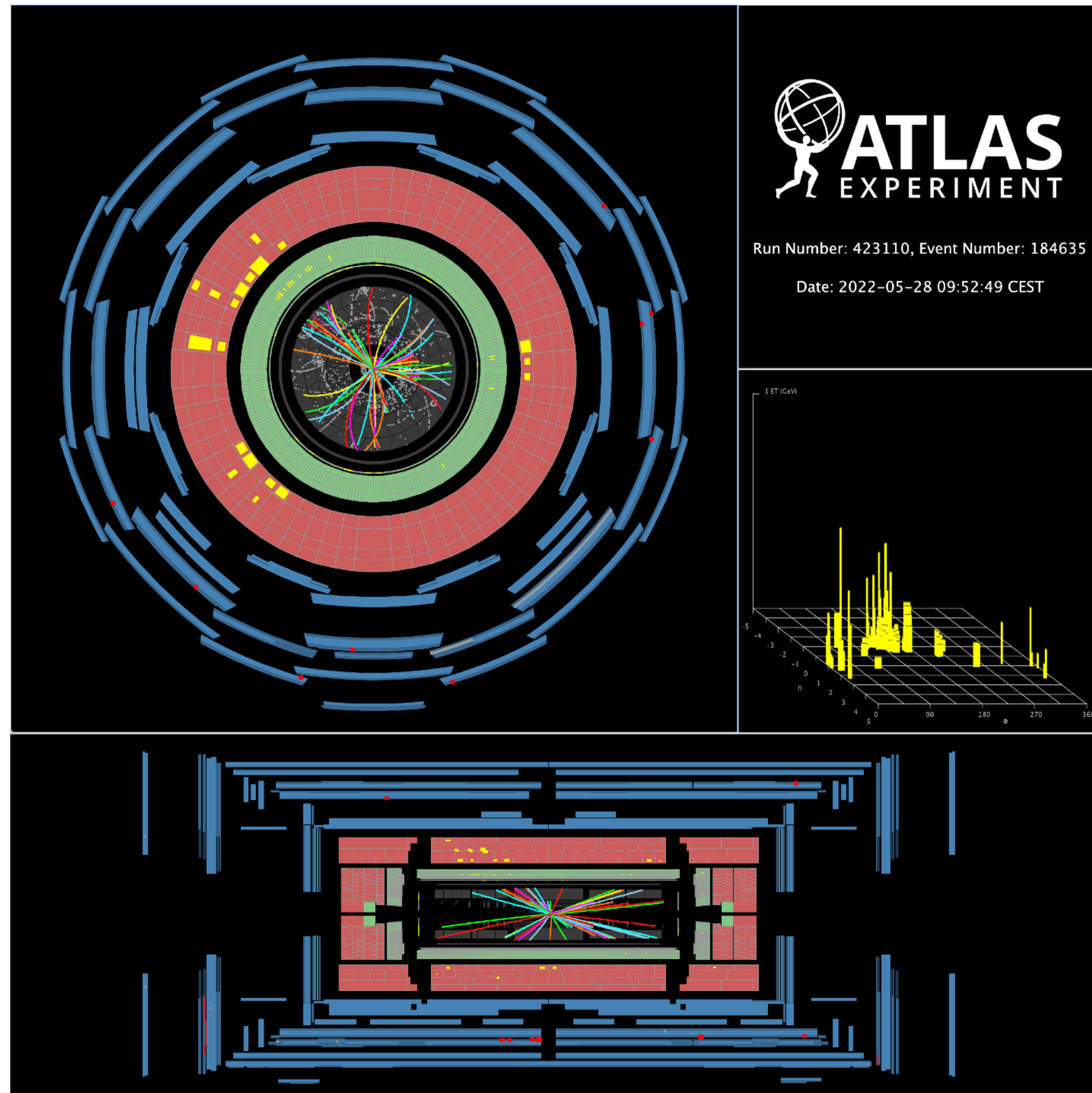

13.6 TeV pp collision data

Started July 5th

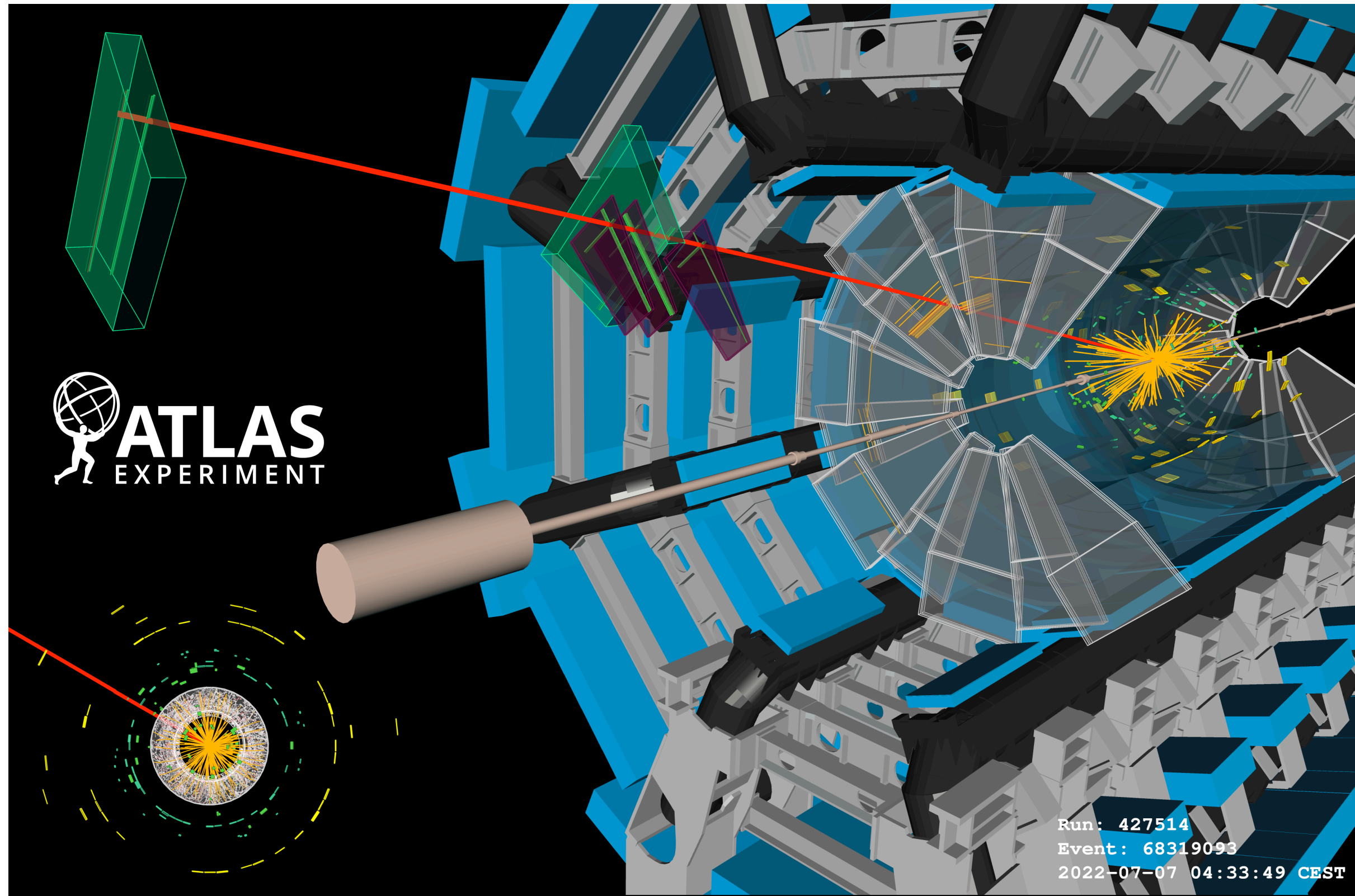

μ reconstructed using new NSW detector

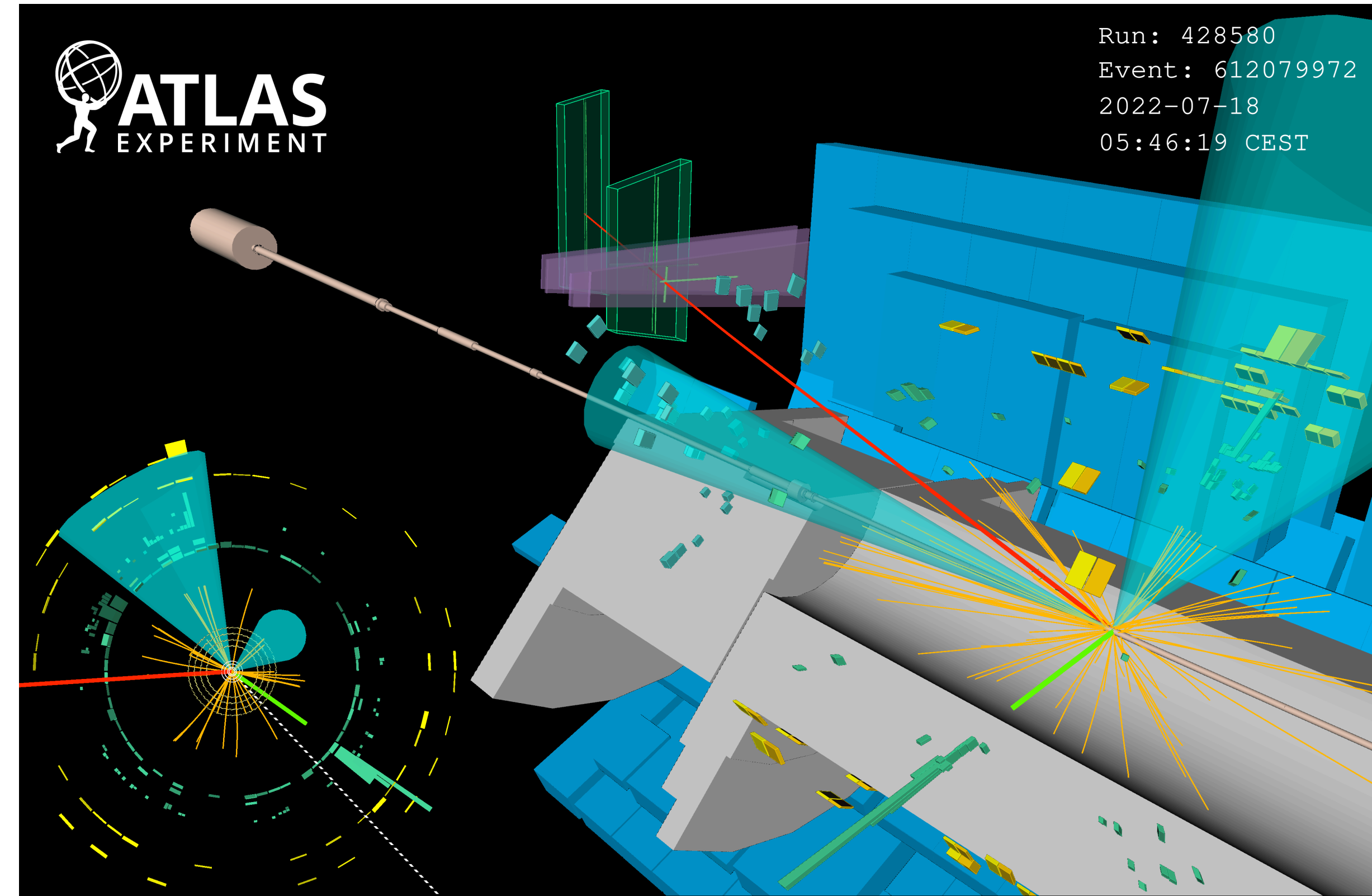

$pp \rightarrow t\bar{t} \rightarrow e\mu\nu\nu\bar{b}\bar{b}$ candidate

See also <https://atlas.web.cern.ch/Atlas/GROUPS/DATAPREPARATION/DataSummary/2022/>

Detector performance with early 2022 data

ATL-PHYS-PUB-2022-033

900 GeV data

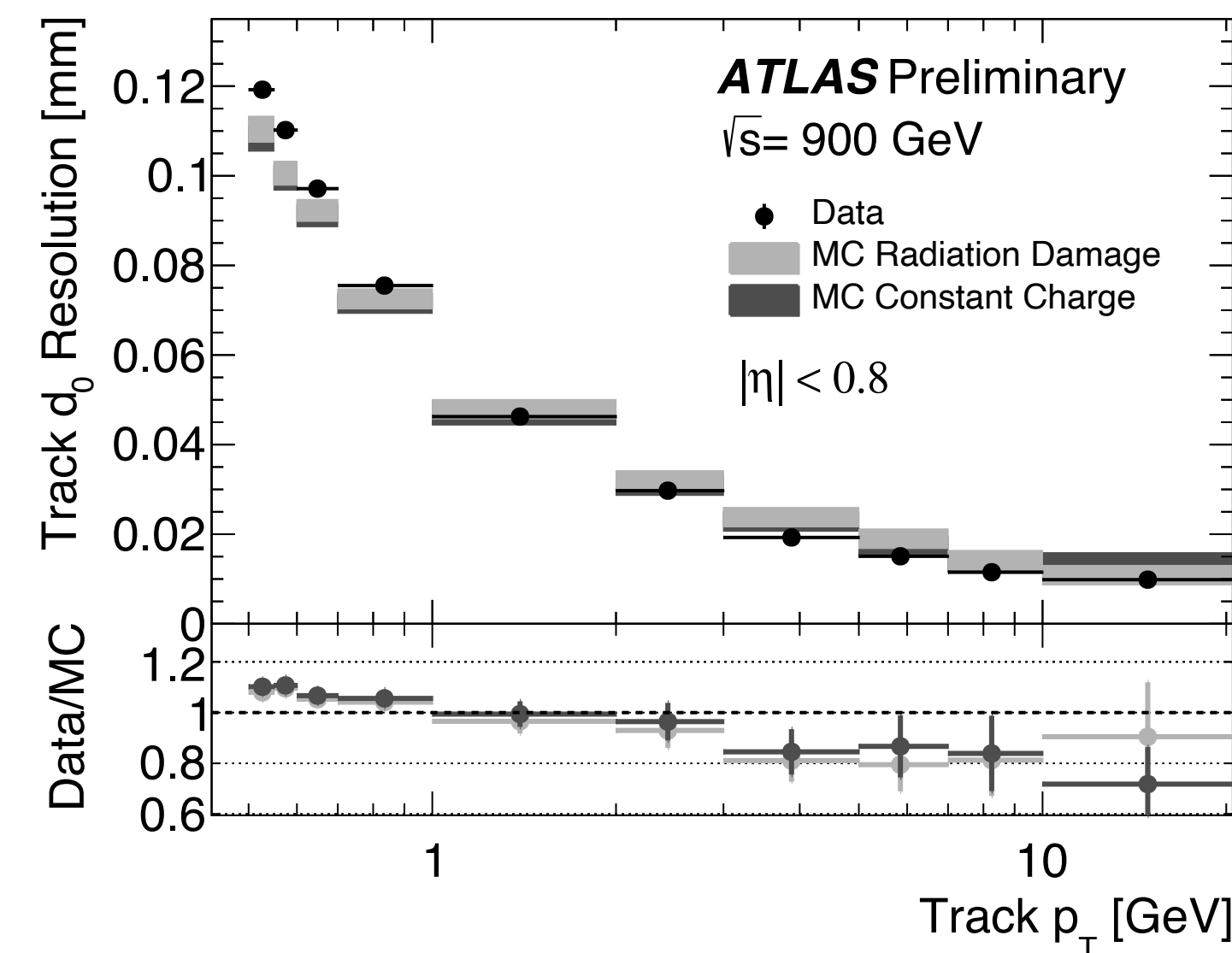
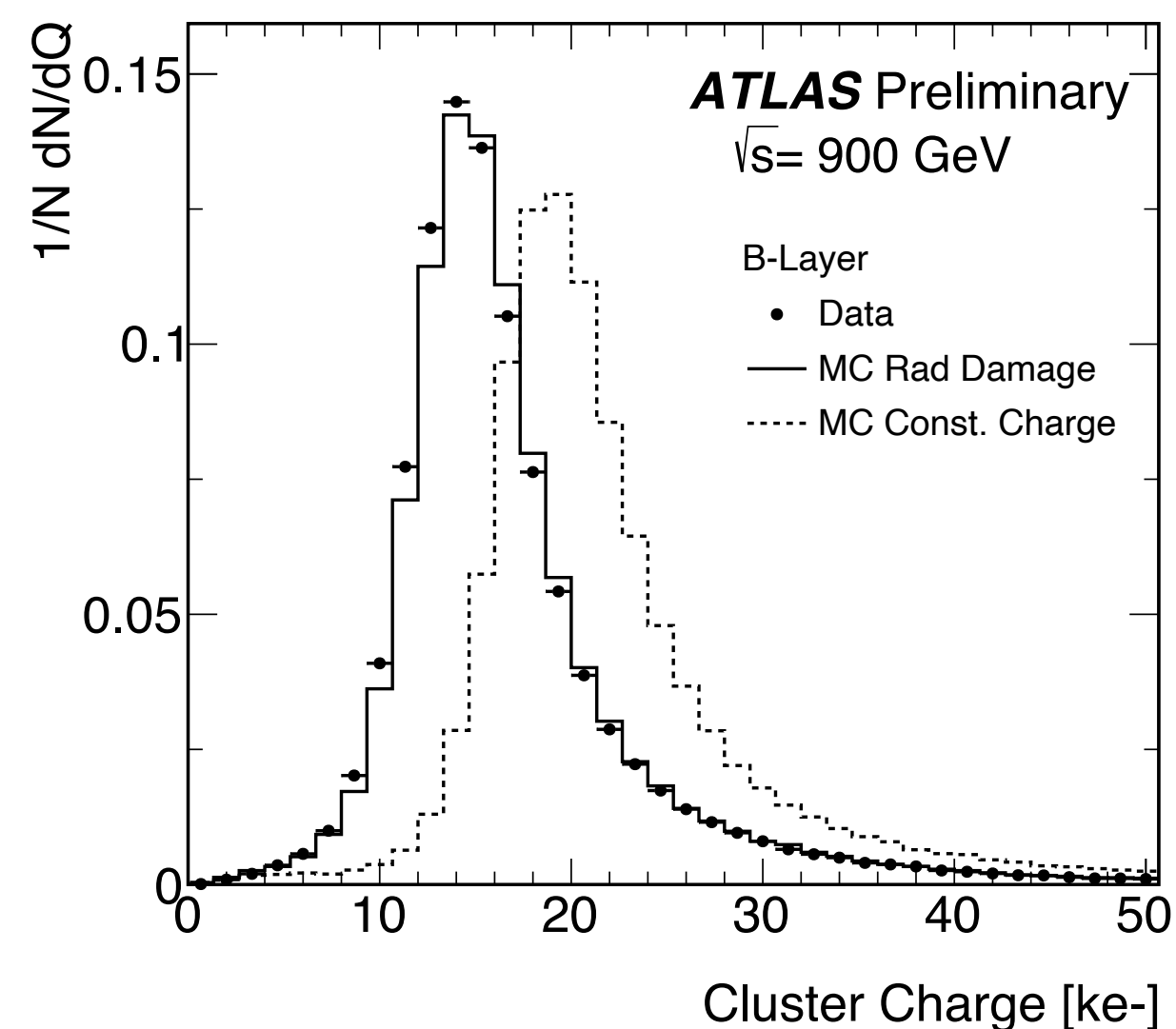

13.6 TeV data

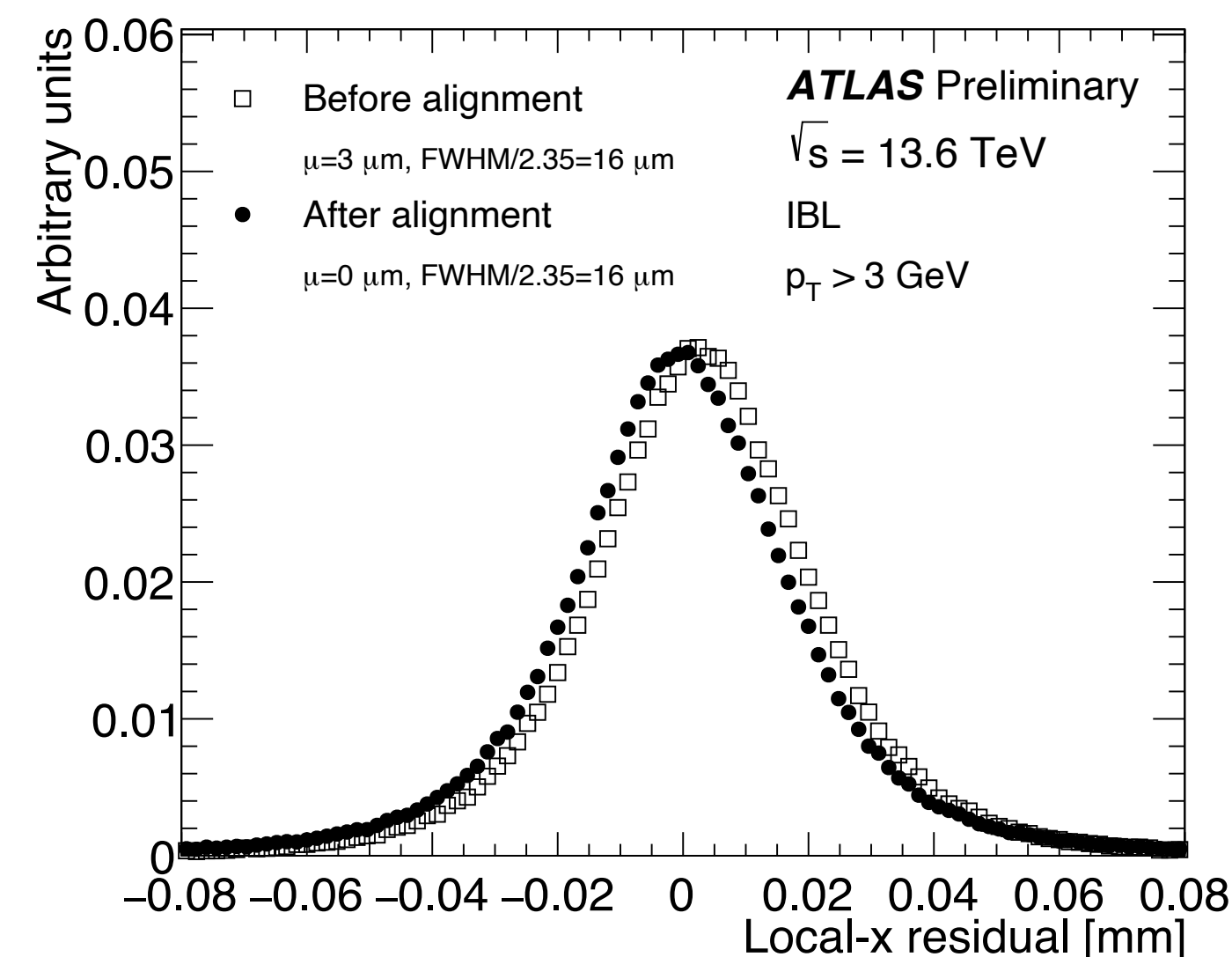
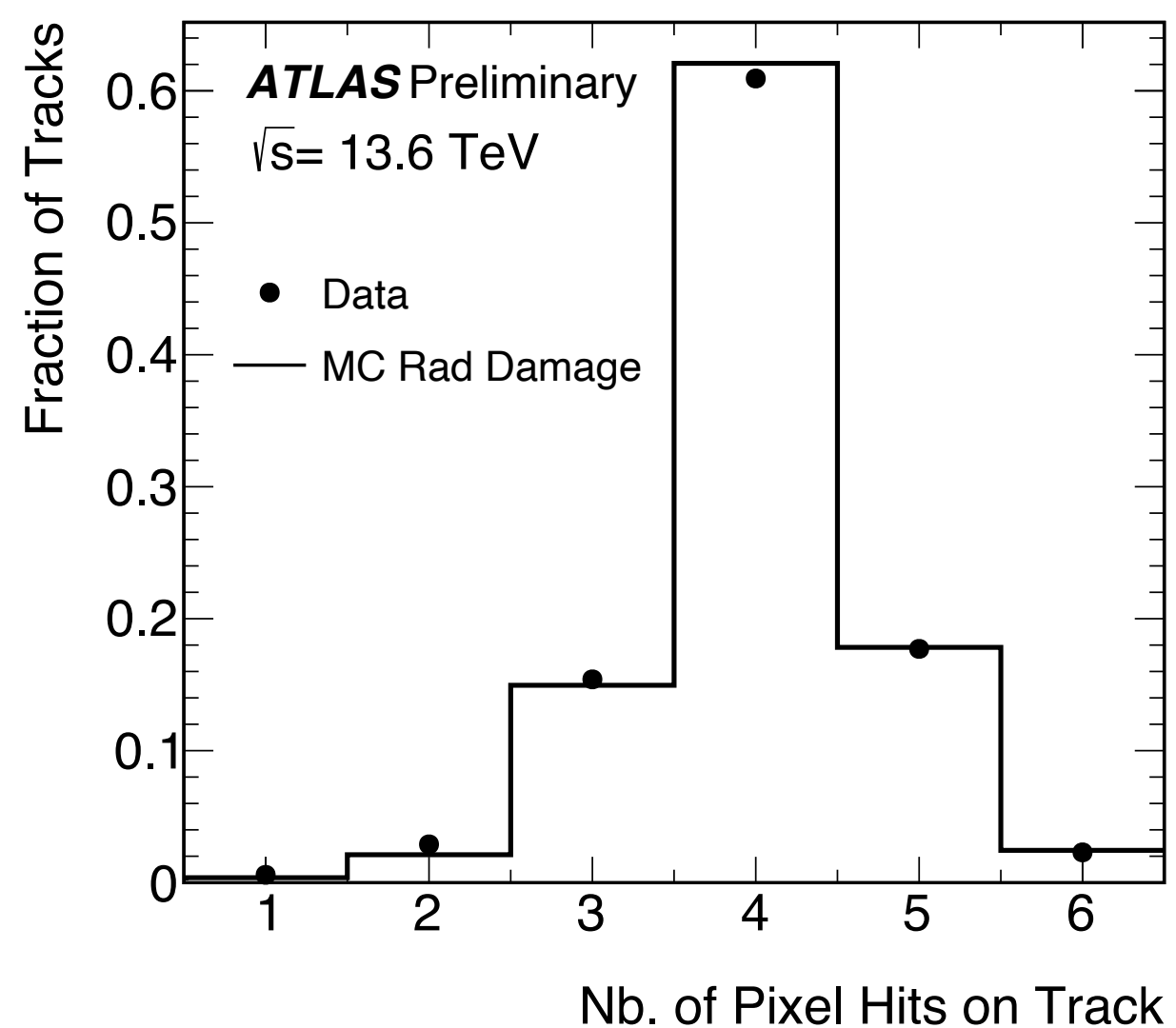

IDTR-2022-06

Phase-2 preparations



ATLAS Phase-2 Upgrade for HL-LHC

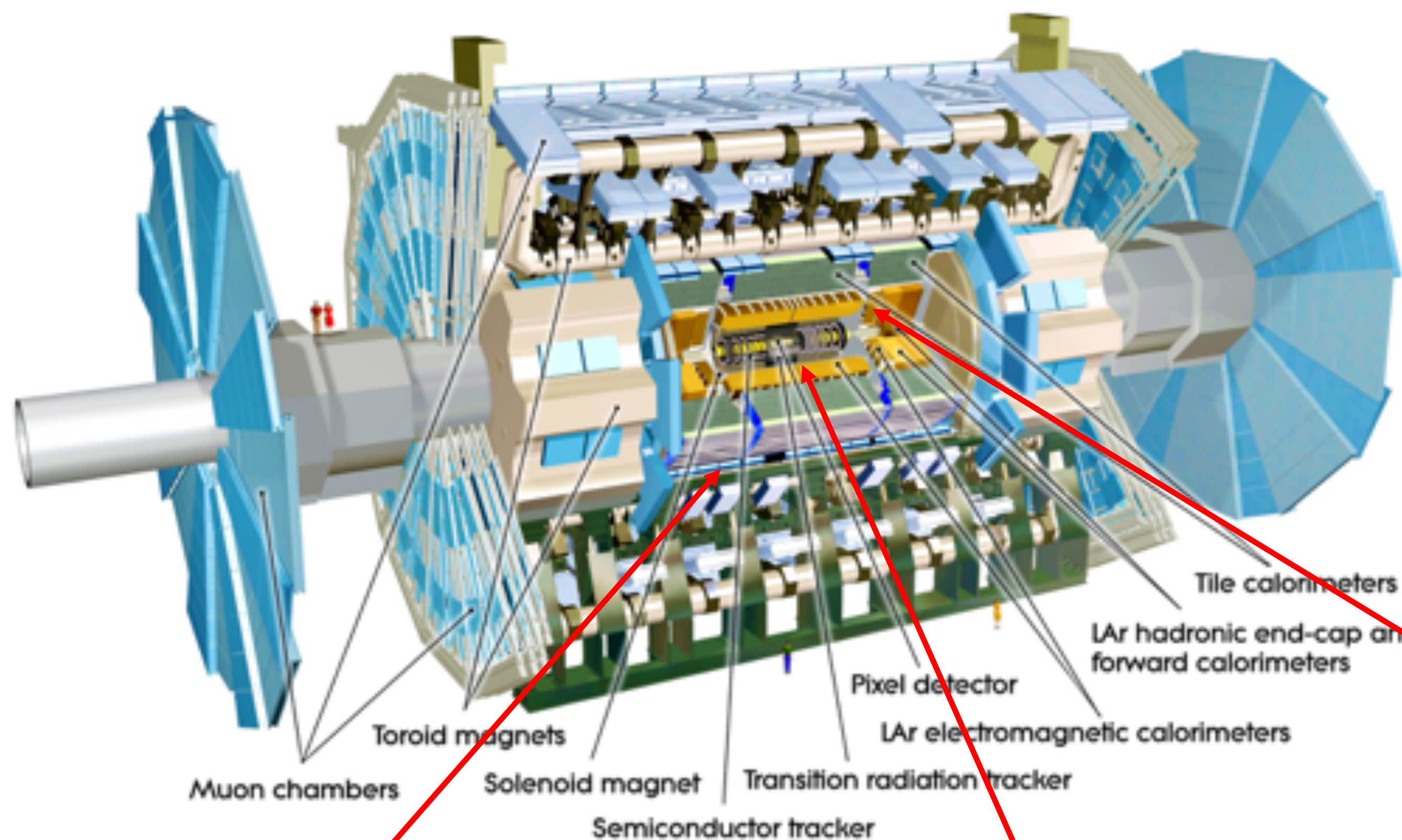

Upgraded Trigger and Data Acquisition system

Level-0 Trigger at 1 MHz

Improved High-Level Trigger
(150 kHz full-scan tracking)

Electronics Upgrades

LAr Calorimeter

Tile Calorimeter

Muon system

High Granularity Timing Detector (HGTD)

Forward region ($2.4 < |\eta| < 4.0$)

Low-Gain Avalanche Detectors (LGAD)
with 30 ps track resolution

Additional small upgrades

Luminosity detectors (1% precision goal)

HL-ZDC

New Muon Chambers

Inner barrel region with new
RPC and sMDT detectors

New Inner Tracking Detector (ITk)

All silicon, up to $|\eta| = 4$

Detailed scope described in 7 TDRs approved by the CERN Research Board in 2017, 2018, 2020

ATLAS Phase-2 Upgrade for HL-LHC



HGTD LGAD wafer under testing

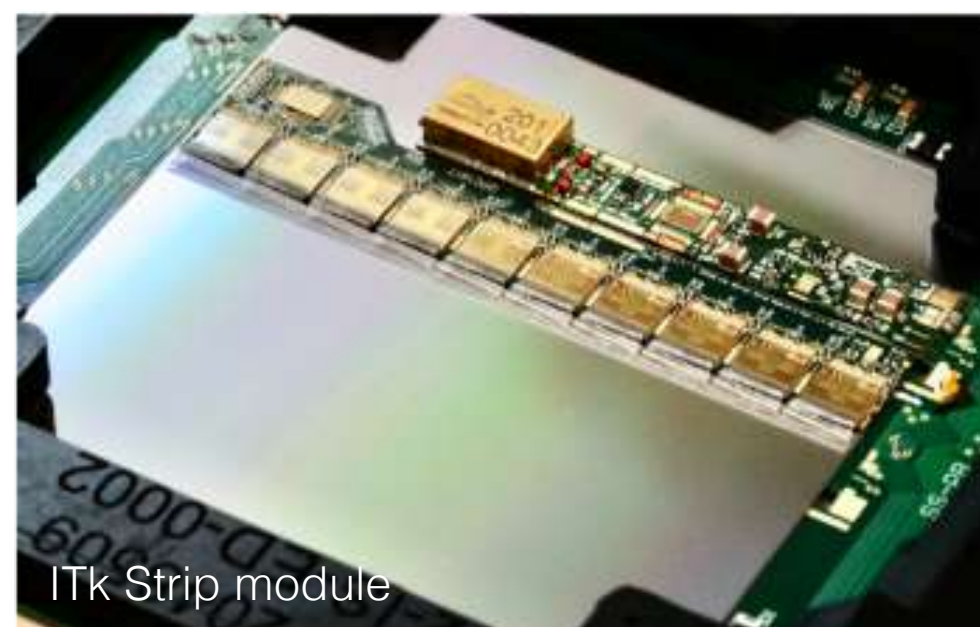

ITk Strip module

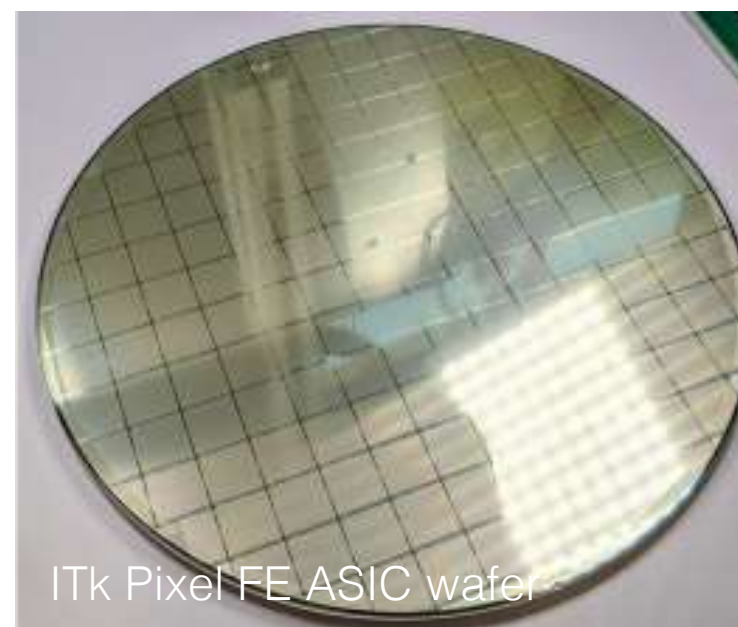

ITk Pixel FE ASIC wafer



Global Trigger prototype

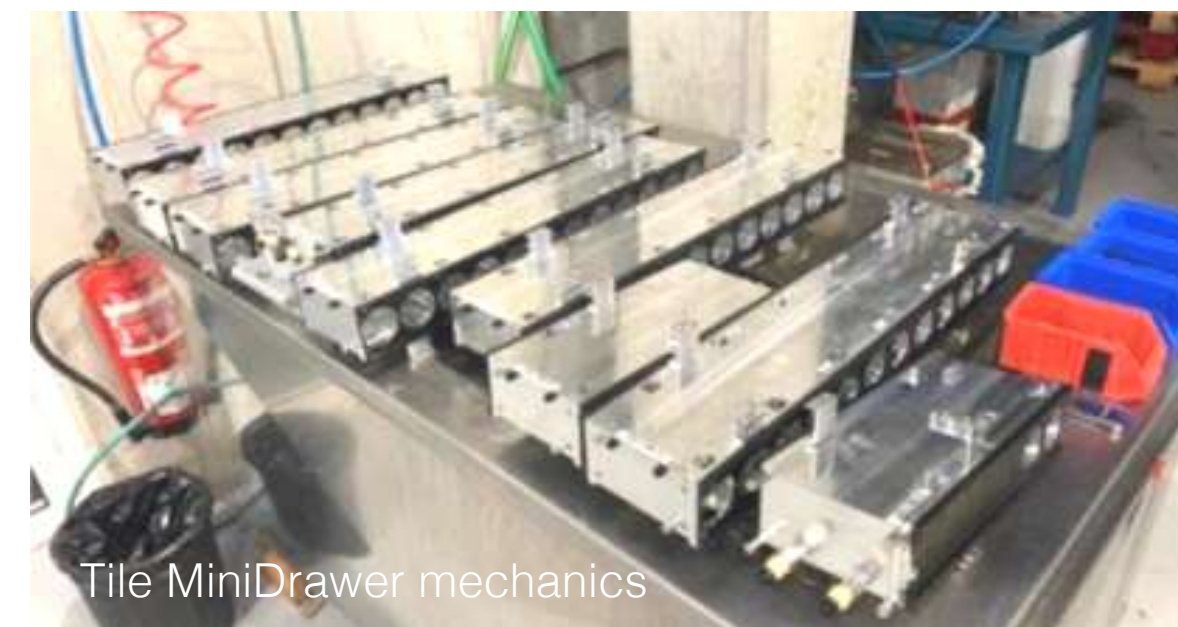

Tile MiniDrawer mechanics



ITk Pixel module loading



ITk Strip FE ASIC in test beam



ITk Strip endcap petal



SMDT geometry measurements



HGTD testbeam at DESY



ITk Pixel Inner System ring with modules

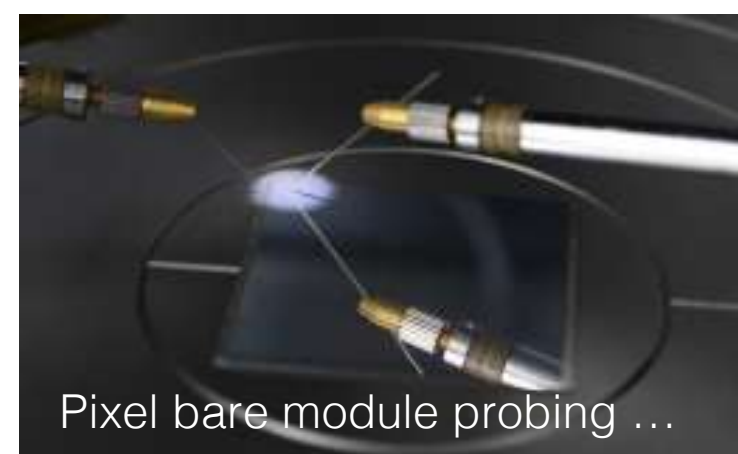

Pixel bare module probing ...

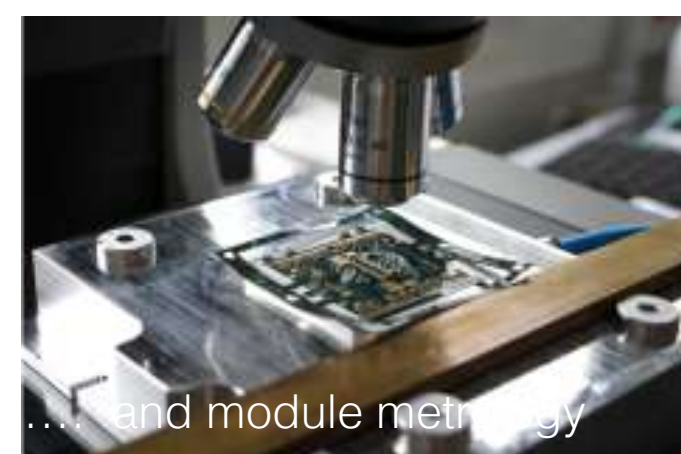

... and module metrology

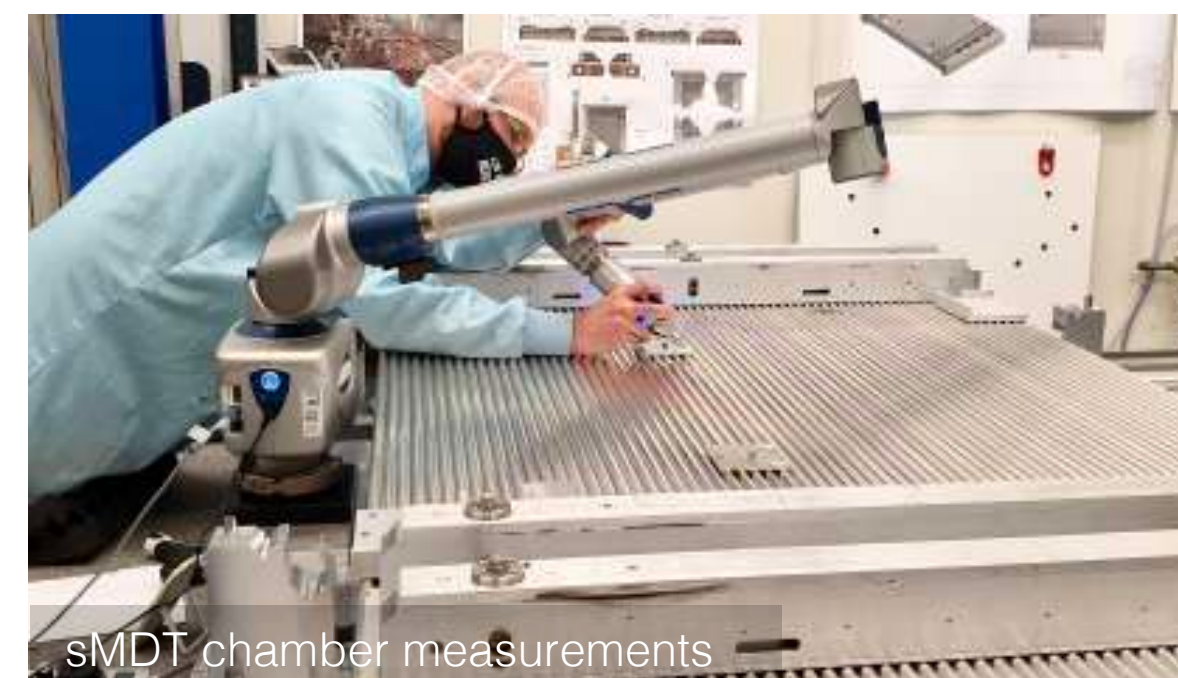

SMDT chamber measurements

Summary and conclusions

ATLAS continues to produce exciting physics results, exploiting the full Run-2 dataset and preparing for combinations with Run-3 data

- Standard Model measurements over a wide range of phase space
- reaching 5–10% constraints on main Higgs-boson couplings
- wide program for BSM physics search

Run-3 has started with $\sqrt{s} = 13.6$ TeV

- expect to collect a large dataset until 2025, ~double of run-2 dataset

Very significant effort to prepare detector upgrades for HL-LHC

- precision measurement of Higgs boson, rare decays and sensitivity to HH production
- and many other measurements and searches

Further ATLAS (+ CMS) talks at this Workshop

Today

- Higgs boson property measurements (ATLAS/CMS) – **Lydia Brenner**
- Measurements of quartic coupling and VBS (ATLAS) – **Diana Pyatiizbyantseva**
- ATLAS Inner tracker upgrade in view of HL-LHC – **Dimitris Varouchas**

Tomorrow

- Searches for new phenomena in leptonic final states (ATLAS) - **Daniel Wilbern**

Saturday

- Searches for Supersymmetry (ATLAS/CMS) – **Vasiliki Mitsou**

Monday next week

- Searches for dark matter (ATLAS/CMS) – **Nishu Nishu**
- Searches for additional Higgs bosons (ATLAS) – **Liljana Morvaj**